Trig[®] Desking

PRICE LIST | JANUARY 2022

For Canadian pricing, please visit Trendealer to see the current conversion rate being used or contact your local Trendway Representative.

Trig Desking

Trig Desking is a fully integrated line of laminate freestanding components including desks, credenzas, tables and laminate storage. This line offers high-end aesthetics, with a range of styling options and finishes.

Trendway product catalogs are available in the following design software: 20/20 (CAP/Giza) and Project Matrix. The Core price book is also available in .pdf (Acrobat Reader) format on www.trenddealer.com. For Architects and Designers, a free FSL (Furniture Symbol Library) is available on dealer.trendway.com.

Product dimensions are given throughout the product catalog and are followed by parenthesis which have the metric equivalent in millimeters. For example: A Rectangular Work Surface is available in a 48" (1219)-width.

Ordering Information

The most efficient way to enter an order is through Trendway On-Line Order Entry on dealer.trendway.com, which also accepts .sif files from the design software listed above. Faxed orders are available as well but may extend lead-times.

For ease in specifying, Trendway's catalog numbering system uses meaningful characters to convey description, surface type, and size. For example, TRGRECD2048 represents a Trig Rectangle Desk that is 20" (508) deep and 48" (1219)-wide.

Order specification examples are shown throughout the price book at the bottom of each page. Be sure to follow the order sequence carefully to ensure complete and accurate order specification.

After placing an order, Trendway will send an order acknowledgement that follows the sequence of information outlined below. Trendway encourages you to follow the same steps so that checking your order against the acknowledgement will be as easy as possible.

Placing an Order

To make placing an order simple, Trendway On-Line Order Entry automatically prompts the product and option decisions that are required. For accurate order processing on faxed orders, please type or use legible handwriting, and be sure to include the following information:

1. A complete "sold to" address with correct Zip code.

2. A complete "ship to" address with correct Zip code.
3. A purchase order number. (The order is issued to Trendway Corporation, Holland, Michigan.)
4. A signature or name of person authorizing the purchase order.
5. A contact name and phone number at your company.
6. An actual calendar date for the requested delivery date (not ASAP).
7. Line items that are complete, which means all catalog numbers and descriptions, options listed for each product selected, fabric/finish pattern and color descriptions, and all corresponding letter or number codes. Be sure to make a pick for all available options. Also, combine identical items and specify total quantity unless using special marking or tagging.

(Refer to your price list for ordering options.)

8. Special products referenced by their control numbers as well as their descriptions.
9. Line items that include price per unit, as well as extended totals.
10. A total dollar amount for the purchase order.
11. Any special shipping requirements clearly noted; i.e., "call before delivery."

By placing your orders correctly and completely the first time around, your order will be processed and scheduled without delay (subject to credit approval).

Lead-Times

The majority of Trig Desking products are shipped within Trendway's standard lead time.

Note: Shipping lead-times are subject to product availability due to order size. For exact lead-times on your order contact Trendway Customer Care.

Product Questions, Quotes & Order Placement On-Line

dealer.trendway.com
Hours: 24 Hours, 7 Days a Week

Customer Care Representative

Hours: Monday–Friday
7:30 am–5:30 pm EST
Phone: 1-800-893-8115
Fax: 1-800-893-8121
e-mail: customercare@trendway.com

Trendway Custom Solutions

Phone: 1-800-893-8117

For more information on Order Placement, Confirmation, and Lead-Times, see the Pricing, Procedures & Policies section in the back of the price book.

1. Transportation

All orders are shipped by Trendway truck or common carrier. List prices shown include Trendway specified freight cost on all orders. For additional information about transportation, contact Trendway Customer Care 1-800-893-8115.

2. Prices

Prices shown in this offering are F.O.B. origin, freight prepaid. Trendway reserves the right to change prices without notice.

Sequence Information

The table shows a sample of the price book format's sequence of information which will assist when placing an order and checking an order acknowledgement.

	Catalog Number	Top Color
Sample Part Number:	TRGRECD2048	.XZ3

Trig | Desks | Work Surfaces | Screens & Modesties | Tables | Filing + Storage | Statement of Line

Overview & Order Information

Statement of Line

Surface Materials

Desks & Work Surfaces

Screens & Modesties

Storage

Benching Electrical

Electrical

Accessories

Terms, Policies & Index

Desks

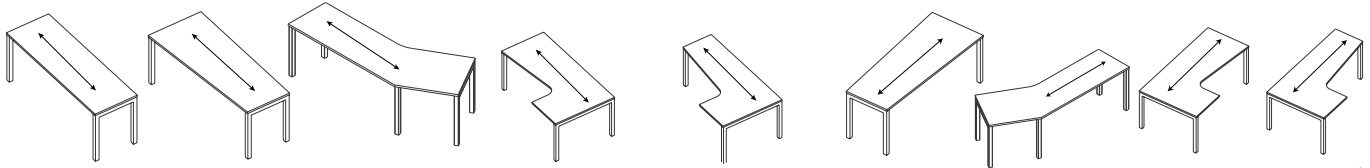

D	W*	D1	W*	D2	D1	W	D2	D1	W*	D2	D3	D1	W*	D2	D3	Right-Hand
20" x 36"		24" x 54"	20"		30" x 94"	24"		30" x 54"	42"	24"		42" x 54"	20"	24"		
20" x 72"		24" x 72"	20"					30" x 72"	42"	24"		42" x 72"	20"	24"		
24" x 36"		30" x 54"	20"					30" x 54"	48"	24"		48" x 54"	20"	24"		
24" x 72"		30" x 72"	20"					30" x 72"	48"	24"		48" x 72"	20"	24"		
30" x 36"		30" x 54"	24"													
30" x 72"		30" x 72"	24"													

*widths in increments of 6"

↔ Denotes direction of wood grain

Work Surfaces

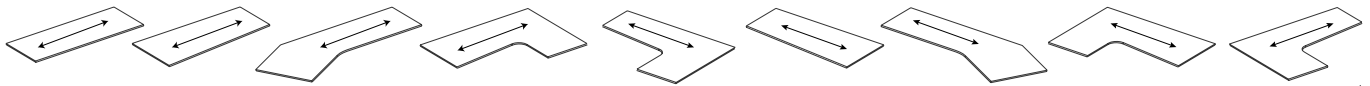

D	W*	D1	W*	D2	D1	W*	D2	D3	D1	W*	D2	D3	Right-Hand
20" x 48"		24" x 54"	20"		30" x 54"	42"	24"		42" x 54"	20"	24"		
20" x 84"		24" x 84"	20"		30" x 84"	42"	24"		42" x 84"	20"	24"		
24" x 48"		30" x 54"	20"		30" x 54"	48"	24"		48" x 54"	20"	24"		
24" x 84"		30" x 84"	20"		30" x 84"	48"	24"		48" x 84"	20"	24"		
30" x 48"		30" x 54"	24"										
30" x 84"		30" x 84"	24"										

*widths in increments of 6"

Work Surface Support Legs

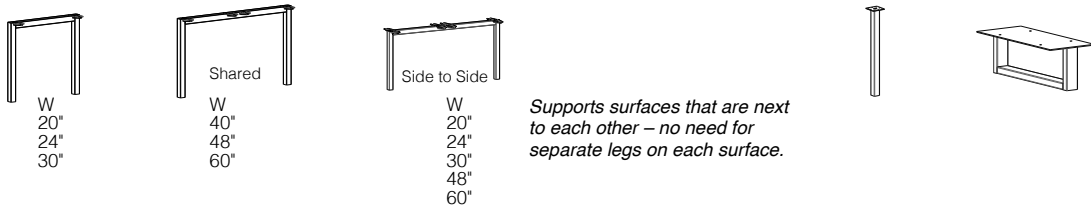

Supports surfaces that are next to each other – no need for separate legs on each surface.

Screens & Modesties

Desk Top Screens | Surface Mount Screens | Back Edge Mount Screens | Modesty | Screen/Modesty Combination | Post Mount Screens

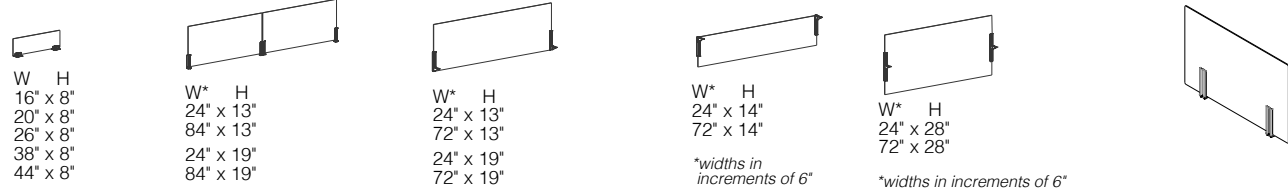

W	H
16" x 8"	
20" x 8"	
26" x 8"	
38" x 8"	
44" x 8"	
16" x 13"	
20" x 13"	
26" x 13"	
38" x 13"	
44" x 13"	

W*	H
24" x 13"	
84" x 13"	
24" x 19"	
84" x 19"	

*widths in increments of 6"

W*	H
24" x 13"	
72" x 13"	
24" x 19"	
72" x 19"	

*widths in increments of 6"

W*	H
24" x 14"	
72" x 14"	

*widths in increments of 6"

W*	H
24" x 28"	
72" x 28"	

*widths in increments of 6"

Post Mount Screen - U Configuration

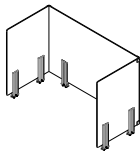

Low Profile Bracket Screen - U Configuration

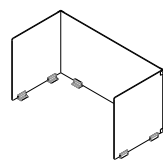

Back Edge Clamp Mount Screen



Desk Top Clamp Mount Screen



Fabric Mounted Screens

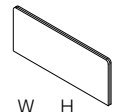

W	H
18" x 13"	
71 7/8" x 13"	
18" x 19"	
71 7/8" x 19"	
23 3/4" x 28"	
71 3/4" x 28"	

*widths in increments of 6"

Filing & Storage

Credenzas



D W H
20" x 75" x 26³/₄"

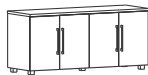

D W H
20" x 60" x 26³/₄"



D W H
20" x 45" x 26³/₄"



D W H
20" x 45" x 26³/₄"



D W H
20" x 30" x 26³/₄"



D W H
20" x 45" x 26³/₄"



D W H
20" x 30" x 26³/₄"
20" x 36" x 26³/₄"

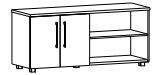

D W H
20" x 60" x 26³/₄"



D W H
20" x 30" x 26³/₄"

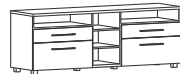

D W H
20" x 75" x 26³/₄"



D W H
20" x 60" x 26³/₄"



D W H
20" x 45" x 26³/₄"

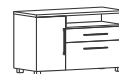

D W H
20" x 45" x 26³/₄"



D W H
20" x 45" x 26³/₄"

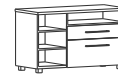

D W H
20" x 45" x 26³/₄"

Bench-Height Storage

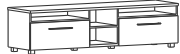

D W H
20" x 75" x 21"

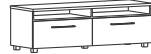

D W H
20" x 60" x 21"



D W H
20" x 45" x 21"

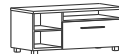

D W H
20" x 45" x 21"



D W H
20" x 30" x 21"



D W H
20" x 30" x 21"
20" x 36" x 21"

Freestanding Storage



D W H
20" x 30" x 26³/₄"



D W H
20" x 15¹/₂" x 26³/₄"



D W H
20" x 30" x 26³/₄"



D W H
20" x 30" x 27³/₄"
24" x 30" x 27³/₄"
30" x 30" x 27³/₄"



D W H
20" x 15¹/₂" x 27³/₄"
24" x 15¹/₂" x 27³/₄"
30" x 15¹/₂" x 27³/₄"



D W H
20" x 30" x 27³/₄"
24" x 30" x 27³/₄"
30" x 30" x 27³/₄"

Under Desk Support Storage

Stack Storage - Open Shelf*



D W H*
14" x 30" x 27¹/₄"



D W H*
14" x 30" x 39¹/₄"

Stack Storage - Paper Management



D W* H
14" x 30" x 5"
14" x 45" x 5"
14" x 60" x 5"
14" x 75" x 5"

Trig to Panel Bracket

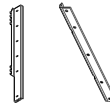

Will allow Trig Work Surface Legs and Storage Units to directly connect to Choices Panels.

*To match 54" & 66" high Storage Towers when placed on top of 26.75" high Credenzas.

*To match Credenza Storage widths

Overhead - Single and Dual Sliding Door

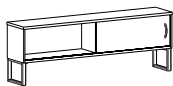

D W* H
14" x 48" x 15¹/₂"
14" x 72" x 15¹/₂"

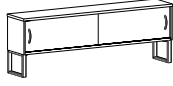

D W* H
14" x 48" x 15¹/₂"
14" x 72" x 15¹/₂"

Overhead - Open Shelf



D W* H
14" x 48" x 15¹/₂"
14" x 84" x 15¹/₂"

Overhead - Hinged Doors**

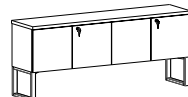

D W* H
14" x 60" x 15¹/₂"
14" x 84" x 15¹/₂"

**Widths in 6" increments.

**The same door size is used for all units. Overheads 66" and wider will have a center open cubby, which increases in width proportionately with the width of the overall unit.

Combination Storage



D W H
20" x 30" x 53³/₄"

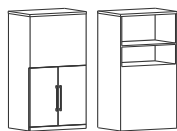

D W H
20" x 30" x 53³/₄"



D W H
20" x 45" x 53³/₄"

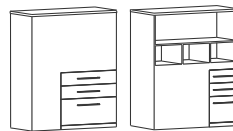

D W H
20" x 45" x 53³/₄"

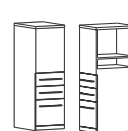

D W H
20" x 15¹/₂" x 47³/₄"
24" x 15¹/₂" x 47³/₄"
30" x 15¹/₂" x 47³/₄"

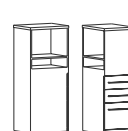

D W H
20" x 15¹/₂" x 47³/₄"
24" x 15¹/₂" x 47³/₄"
30" x 15¹/₂" x 47³/₄"

Filing & Storage Continued

Tower Storage

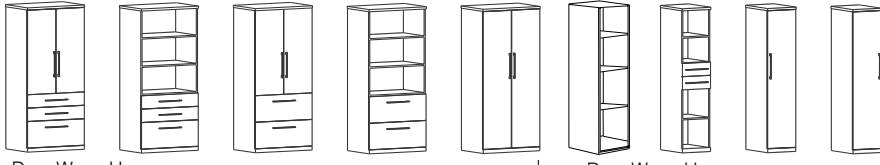

D W H
20" x 30" x 65^{3/4}"

D W H
20" x 15" x 65^{3/4}"



D W H
20" x 30" x 53^{3/4}"

D W H
20" x 15" x 53^{3/4}"

Door Style Options

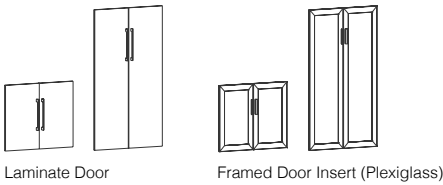

Laminate Door

Framed Door Insert (Plexiglass)

Wardrobe Storage

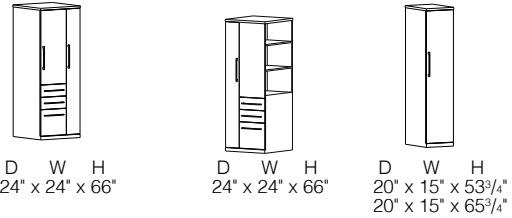

D W H
24" x 24" x 66"

D W H
24" x 24" x 66"

D W H
20" x 15" x 53^{3/4}"
20" x 15" x 65^{3/4}"

Benching Electrical

Power Raceway

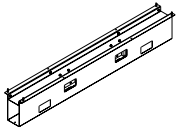

Power Grommets



2 Power



1 Power 1 USB

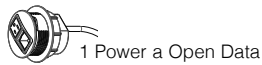

1 Power a Open Data

Accessories

Monitor Arms

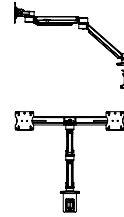

Lighting



Tables



D W H
36" x 72" x 28^{3/4}"
42" x 72" x 28^{3/4}"
48" x 72" x 28^{3/4}"
48" x 96" x 28^{3/4}"
48" x 120" x 28^{3/4}"
48" x 144" x 28^{3/4}"

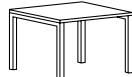

D/W H
36" x 28^{3/4}"
42" x 28^{3/4}"
48" x 28^{3/4}"

Note: See the Tables Price Book for the complete Tables offering.

Surface Material Program

The Trendway Surface Material Program includes a broad selection of coordinated fabrics, laminate and trim finish options. Additionally, Trendway offers a Customers Own Material (COM) program to allow customers to further personalize their work stations.

The following sections describe the Trendway Surface Materials vocabulary.

Standard Program

Trendway's Standard Program of timeless and popular fabrics, finishes, vinyls and laminates, is recommended for corporate standards programs. These fabrics are carded and swatched by Trendway. Materials in the Trendway Standard Program offering are readily available for orders to ship within 2-4 weeks. Refer to individual panels for fire rating classifications.

Scheduled Program

Trendway's Schedule Program is made up of additional colors of standard patterns, as well as an evolving collection of fabrics from our textile partners designed to solve all your needs. Influenced and kept up to date by emerging trends, the typical life span in this program is one to three years and is not considered part of the standard program. To see the Scheduled fabrics go to the the surface material page on our website at www.Trendway.com and filter for "Scheduled" under "Lead-Times". Scheduled fabrics may have different lead time than standard fabrics. Please call Trendway customer care for estimated ship dates.

Both Standard and Scheduled Materials in this program comply with the industry standards for quality and performance.

They all pass California Technical Bulletin 117-2013 and are listed as part of the UL recognized component program.

Terratex®

Terratex is a Duvaltex brand designating fabrics that are made from 100% recycled or compostable material using increasingly sustainable manufacturing practices to produce a high-quality product that is recyclable at the end of its useful life. For more information, go to www.terratex.com.

COM

Customers Own Material program allows customers to select and specify their own fabric or laminate on Trendway product. For detailed information see item #11 (COM) in the Pricing, Procedures and Policies section in the back of the price list or on Trenddealer.com.

Pre-Approved COM

Select from popular COM fabrics pre-approved by Trendway. Customers are able to search the COM library on dealer.trendway.com for fabrics and specific applications that have passed manufacturability testing on Trendway product.

HOW TO ORDER SAMPLES

Standard Program Binder Cards

Seating and panel binder cards are available through Trendway fulfillment. dealer.trendway.com

Standard Program Samples

Samples of fabrics and finishes are available through Trendway fulfillment. dealer.trendway.com

Scheduled Samples

Samples must be ordered directly through the supplier. Contact information is listed below and also on our website www.trendway.com/surfacematerials. Click on the link next to the swatch samples.

Camira

www.camirafabrics.com
1-616-288-0655

Culp Contract

www.culpcontract.com
336-888-6274

Guilford Of Maine®

www.guilfordofmaine.com
1-800-544-0200

Mayer Fabrics

www.mayerfabrics.com
1-800-428-4415

Momentum® Textiles

www.memosamples.com
1-800-366-6839

Nevamar

www.nevamar.com
1-800-638-4380

Pionite

www.pionite.com
1-800-746-6483

Ultrafabrics®

www.ultrafabricsinc.com
914-460-1730

Wilsonart®

www.wilsonart.com
1-800-433-3222

Surface Material Legend

 = 100% Recycled Content

 = Bleach Cleanable. Refer to specific cleaning instructions for each fabric on www.Trendway.com.

Pattern	Capture Tiles	Choices Panels & All Systems Components	Fabric Screens	Tackboards		TrendWall	Volo	Cushion Tops
				> 60"	< 60"			
Amaze	↓	↓	↓	R	↓	↓	↓	•
Anchorage	↓	↓	↓	R	↓	•	↓	•
Aurora	↓	↓	↓	R	↓	↓	↓	•
Chase	↓	↓	↓	R	↓	↓	↓	•
Framework	↕	↕	↕	↕	↕	•	↕	•
Glint	↓	↓	↓	R	↓	↓	↓	•
Intermix	↓	↓	•	R	↓	↓	↓	•
Intuition*	↓	•	•	R	↓	•	↓	↓
Merge	↕	↕	↕	↕	↕	↕	↕	↕
Mingle	↓	↓	↓	R	↓	•	•	•
Netiquette**	↓	•	•	R	↓	↓	↓	•
Pact	↓	↓	↓	R	↓	↓	↓	•
Pursuit	↓	↓	↓	R	↓	↓	↓	•
Tabby Weave	↕	↕	↕	↕	↕	↕	↕	•

- Not Available
- ↕ Non Directional - Pattern will be applied for best yield
- ↓ Down Roll - The height dimension of the tile or component is parallel to the warp of the fabric
- R Railroaded - The height dimension of the tile or component is perpendicular to the warp of the fabric
- * Multi-use fabric (seating and panel) available on Capture, Fabric Screens, and Volo
- ** Not available on Choices Panels, but approved on Choice's Tackboards and Flipper Doors

Down-Roll (↓)

Down-roll means the height dimension of the tile or component is parallel to the warp of the fabric (Fig. A).

Fig. A

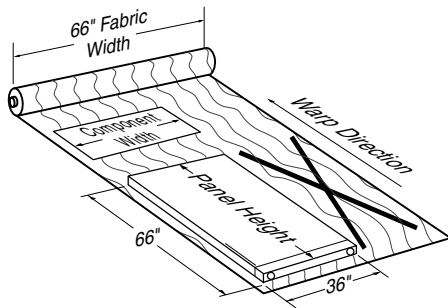

Railroad

Railroad means the height dimension of the tile or component is perpendicular to the warp of the fabric (Fig. B).

Fig. B

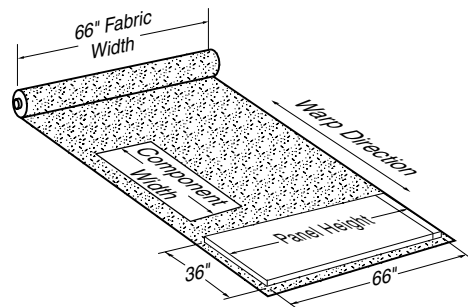

COM Fabrics

COM fabrics may be applied either Down-roll (Fig. A) or Railroad (Fig. B). When choosing Railroad on COM fabrics please note that 84" (2134)-high Choices and TrendWall Panels cannot be Railroad due to panel fabric being 66" (1676)-wide (Fig. C).

Fig. C

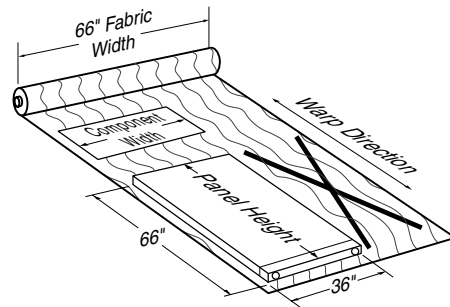

Standard Panel Fabrics

Framework	Grade 0	Intermix 	Grade 1	Tabby Weave 	Grade 2
Value Fabric		 Guilford of Maine		QQ3	Cement Mix
KK1	Cappuccino	KDM	Foggy	175	Crystal Blue
BJ7	Dove Gray	KDK	Husky	238	Grey Mix
KK2	Espresso	KDT	Neptune	K99	Medium Grey
B4Y	Eucalyptus	KDJ	Rocket Ship	380	Quartz
B4X	Gray Blue	KDH	Seagull	BV2	Silver Papier
KJX	Grotto	KDV	Smoky Quartz	150	Wedgewood
BFP	Hunter	KDR	Swan		
BFR	Marble				
B4V	Sandy Pebble				
BG8	Twilight				
		Mingle	Grade 1	Anchorage 	Grade 3
		Guilford of Maine		Guilford Of Maine	
Merge	Grade 0	Z53	Biscuit	AR1	Angora
Z42	Dove	Z4X	Carbon	AR0	Asteroid
Z43	Driftwood	Z4Y	Crystal	BF4	Aubergine
Z44	Eucalyptus	Z52	Wheatberry	AQ8	Birch
Z45	Fawn	Z51	Winter	BF9	Cobalt
Z46	Fire Engine			AQ7	Deep Water
Z47	Graphite			BFM	Graphite
Z49	Green Apple	Netiquette	Grade 1	BFF	Green Apple
Z4A	Ivy	KK5	Analog	BFA	Lapis
Z4C	Mandarin	KK3	Chipset	BFD	Midnight
Z4D	Marshmallow	KK4	Dashboard	GEB	Onyx
Z4F	Midnight	KK8	Gamma	KX1	Pool
Z4H	Slate	KK7	Inkjet	BF2	Pumpkin
		KKC	Pixel	AQ6	Quarry Blue
		KK4	Refresh	BFN	Red Delicious
		KK6	Schema	AQ5	Slate
		KK9	Vector	BFC	Thistle
				AQ1	Vanilla
				BXP	Waterfall
				BFG	Willow
				BFJ	Wolf
Amaze	Grade 1	Pursuit 	Grade 1	Glint 	Grade 3
Guilford of Maine		 Guilford of Maine		Momentum	
Z4W	Morel	KDG	Cement	KG4	Caspian
Z4T	Platinum	KDA	Dove	KG5	Column
Z4V	Steel	KDF	Elephant	KG7	Gypsum
Z4U	Sky	KDC	Mist Grey	KG9	Opal
		KD9	Whisper	KJ2	Pumice
		KDD	White Linen	KGC	Relic
				KGE	Serene
				KGf	Shale
Aurora	Grade 1	Pact 	Grade 2	Intuition*	Grade 4
Guilford of Maine		Guilford of Maine		Guilford of Maine	
Z55	Cloud	BM5	Aloe	Z27	Bisque
Z54	Frost	BM8	Coastal	Z2C	Honey
Z56	Latte	BMA	Dove	Z2E	Peacock
Z57	Pewter	BME	Fern	Z2G	Sage
		BMF	Harbour		
		BMJ	Midnight		
		BMM	Patina		
		BMN	Putty		
		BMU	Sketch		
		BMW	Taupe		
		BMX	Toasty		

* Available on Capture, Fabric Screens, and Volo

To see all Trendway fabric options, go to Trendway.com

Standard Systems Finishes

Trendway standard paints include smooth and textured styles in our six trim colors.

Systems Paints and Trim

K	Charcoal
DW	Designer White
G	Gray
L	Light Gray
Y	Sand
J	Stucco
TK	Textured Charcoal
TDW	Textured Designer White
TG	Textured Gray
TL	Textured Light Gray
TY	Textured Sand
TJ	Textured Stucco

Glazed Panels

Plexiglass

01	Clear
E3A	*Frosted

*Tempered Glass

03	Clear
05	Frosted

Ecoresin

The color options are semi-transparent with (or without) patterns.

*3form

E02	Solo Aqua Supermatte Ecoresin
E01	Solo Supermatte Ecoresin
E03	Spider Ecoresin

***Note:** These options are offered at an upcharge. Please refer to a specific item in your price list to determine the amount of upcharge.

Premium Systems Finishes

Premium finishes are offered at a modest upcharge. Please refer to a specific item in your price list to determine the amount of upcharge. Textured colors display a matte texture with metallic highlights. They coordinate with standard Trendway trim colors (indicated by the second letter in the code).

Smooth Metallic Paint

PA	Platinum
----	----------

Standard Vinyl Edgeband

Solid

K	Charcoal
E1	Designer White
E6	Graphite
L	Light Gray
Y	Sand
E7	Shadow
J	Stucco

Patterned

E8	Casual Linen
E9	Classic Linen
EB	Crisp Linen
EG	Earthen Twill
EH	Graphite Twill
EE	Sarum Twill

Woodgrain

W8	Beigewood
WE	Brazilwood
W7	Empire Mahogany
ER	Espresso Pearwood
WY	Finnish Oak
W5	Fusion Maple
E5	Phantom Charcoal
E4	Phantom Ecru
E3	Phantom Pearl
WZ	Walnut
W6	Wild Cherry

** Available on Capture, Fabric Screens, and Volo*

To see all Trendway finish options, go to Trendway.com

High Pressure Laminates – for Work Surfaces and Laminate Tiles

Standard Program

Grade 1

Solid	Pattern	Woodgrain	Woodgrain
583	Charcoal	J6B Casual Linen	J0G Beigewood
J0C	Designer White	J6A Classic Linen	J0D Brazilwood
J9D	Graphite	J69 Crisp Linen	J2A Empire Mahogany
573	Light Gray	J9H Earthen Twill	J9X Espresso Pearwood
J20	Sand	JM4 Evening Tigris	J98 Finnish Oak
J04	Shadow	J9J Graphite Twill	J25 Fusion Maple
J11	Stucco	JN2 Grey Tigris	J99 Walnut
		J09 White Tigris	J1R Wild Cherry
		J9G Sarum Twill	

Grade 2

Thermofused Laminates – for Storage and Laminate Tiles

Standard Program

Solid	Grade 1	Woodgrain	Grade 1
XZ4	Black	XZ8	Beigewood
XZH	Designer White	XZE	Brazilwood
		XZ3	Empire Mahogany
		XY6	Espresso Pearwood
		XZY	Finnish Oak
		XZ2	Fusion Maple
		XZZ	Walnut
		XZ1	Wild Cherry

Woodgrain	Grade 2
XY2	Phantom Charcoal
XY1	Phantom Ecru
XY0	Phantom Pearl

Overview & Order Information

Statement of Line

Surface Materials

Capture Frames

Capture Electrical

Capture Tiles

Capture Components

Capture Filing & Storage

Terms, Policies & Index

CROSS REFERENCE

High Pressure Laminate (HPL), Thermofused Laminate (TFL), Edgebanding, Wood Veneer, Panel Vinyl

Solid Color Name	HPL Capture, Choices, Pack, Worksurfaces	TFL Capture, Intrinsic, Trig	Edgeband	Finish Code	Panel Vinyl Choices, TrendWall, Volo
Black		XZ4			
Charcoal**	583		K	K	V39
Designer White**	J0C	XZH	E1	DW	V52
Graphite	J9D		E6		
Gray**				G	V38
Light Gray**	573		L	L	V51
Platinum**				PA	V53
Sand**	J20		Y	Y	V48
Shadow	J04		E7		
Stucco**	J11		J	J	V49

Pattern Color Name	HPL Capture, Choices, Pack, Worksurfaces	Edgeband
Casual Linen	J6B	E8
Classic Linen	J6A	E9
Crisp Linen	J69	EB
Earthen Twill	J9H	EG
Graphite Twill	J9J	EH
Sarum Twill	J9G	EE

Woodgrain Pattern Name	HPL Capture, Choices, Pack, Worksurfaces	TFL Capture, Intrinsic, Trig	Edgeband	Wood Veneer Choices, Volo	Panel Vinyl TrendWall
American Natural					AS2
Beigewood	J0G	XZ8	W8	M4	
Brazilwood	J0D	XZE	WE	M5	
Empire Mahogany		XZ3	W7	M8	
Espresso Pearwood	J9X	XY6	ER		
Finnish Oak	J98	XZY	WY		
Fusion Maple	J25	XZ2	W5	M2	
Phantom Charcoal	J9C	XY2			
Phantom Ecru	J9B	XY1	E4		
Phantom Pearl	J9A	XY0	E3		
Russian Maple					AS3
Sorrel Pear					AS4
Walnut	J99	XZZ	WZ		
Wild Cherry	J1R	XZ1	W6	M9	

** Trendway standard trim paint color

Trig Keying Order Form

This form can be used as a worksheet or an order form to determine what key-alike Trig Core/Key Sets are needed for key-alike Trig filing and storage, Trig locks on Choices flipper units and for additional Trig Lock Keys, Core Keys and Master Keys*. It is also used to specify special tagging instructions to designate installation locations, which is offered free of charge.

The information on this form can either be entered in Trendway's design software, or through Trendway On-line Order Entry on trenddealer.com using the catalog numbers listed below or it can be used as an order form and faxed to Trendway Customer Care.

Trig Core/Key Set

Trig Core/Key Set includes a lock core and 2 lock key. Trig Core/Key Set numbers are randomly selected from existing inventory unless otherwise specified on this form. Requesting specific numbers** may delay shipment of your key-alike order and may require partial or delayed shipment of your lock cores and keys separately from your order. Additional lock keys are available.

Trig Core Installation/Removal Key

Trig Core Installation/Removal Key is needed to install Core/Key Sets and to remove or replace existing Trig lock cores.

*Trig Master Key

Trig Master Key is used to open any Trig style lock. Master keys are sent out separately from the product order. Request for Master keys must be made on the end users letterhead and faxed to Trendway Customer Care at 1-800-893-8212. Orders are shipped within 24-hours of receipt.



Trig Keying Order Form

Trendway Corporation
13467 Quincy St. Holland MI 49424
Phone: (800) 893-8115 Fax: (800) 893-8121
www.trendway.com

Customer P.O. Number 12345
Trendway Order Number _____

Ship to address if different from P.O. _____

Trig Core/Key Set – TLCK

Qty.	List Price \$13	Key Number S101 - S200	Key-Alike Special Tagging Instructions		
			Floor	Office	
2	\$26	S101	3	5	John's Office
6	\$78	S101	2		Offices 201, 252

Additional Trig Lock Key(s) – TKEY

Qty.	List Price \$8	Key Number S101 - S200	
1	\$8	S101	

Additional Trig Core Installation/Removal Key(s) – TCK

Qty.	List Price \$4	One core removal key is included at no charge for every 50 lock sets ordered.
3	\$12	

Trig Master Key(s)

Trig Master Keys are used to open any Trig style lock. Master keys are sent separately from the product order. Request for Master keys must be made on the end users letterhead and faxed to Trendway Customer Care at 1-800-893-8121. Orders are shipped within 24-hours of receipt.

Sample



Trendway Corporation
 13467 Quincy St. Holland MI 49424
 Phone: (800) 968-5344 Fax: (616) 399-0668
 www.trendway.com

Trig Keying Order Form

Customer P.O. Number _____ Trendway Order Number _____

Ship to address if different from P.O. _____

Trig Core/Key Set – TLCK

Qty.	List Price \$13	Key Number S101 - S200	Key-Alike Special Tagging Instructions		
			Floor	Office	

Additional Trig Lock Key(s) – TKEY

Qty.	List Price \$8	Key Number S101 - S200	

Additional Trig Core Installation/Removal Key(s) – TCK

Qty.	List Price \$4	One core removal key is included at no charge for every 50 lock sets ordered.

Trig Master Key(s)

Trig Master Keys are used to open any Trig style lock. Master keys are sent separately from the product order. Request for Master keys must be made on the end users letterhead and faxed to Trendway Customer Care at 1-800-893-8121. Orders are shipped within 24-hours of receipt.

- Overview & Order Information
- Statement of Line
- Surface Materials
- Desks & Work Surfaces
- Screens & Modesties
- Storage
- Benching Electrical
- Electrical
- Accessories
- Terms, Policies & Index

Trig Core/Key Set

The Trig Core/Key Set must be ordered when the Key-Alike Lock option is chosen to replace the “disposable” core that ships with Trig filing units in order for these units to lock. This set can also be ordered to replace an existing Trig Core/Key Set. Includes a Trig lock core and 2 lock keys.

Trig Core Installation/Removal Key

The Trig Core Installation/Removal Key is needed to install or remove Trig Cores in Trig filing units. One Core Key is included at no charge with every 1 to 50 Trig Core/Key Sets ordered. This key is available if additional Installation/Removal Keys are needed.

Trig Lock Key

Replacement Trig Keys are available for order.

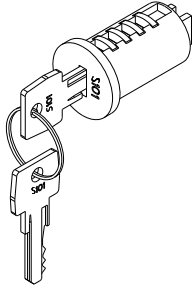

Trig Core/Key Set

	List Price	Catalog Number	Key Number
	\$15	TLCK	S101 - S200

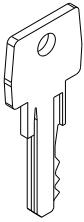

Trig Core Installation/Removal Key

	List Price	Catalog Number	
	\$4	TCK	

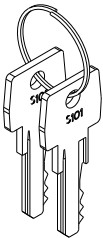

Trig Lock Key

	List Price	Catalog Number	Key Number
	\$8	TKEY	S101 - S200

Sample Part Number:

TKEY	. S112
------	--------

Total Cost \$8 =

\$8	+	N/C
-----	---	-----

Trig Desking

<i>Typical Workstations</i>	16
<i>Overview & Ordering Information</i>	17
<i>Desks</i>	26
<i>Work Surfaces</i>	32
<i>Work Surface Support Legs</i>	38
<i>Work Surface Support Accessories</i>	40
<i>Screens</i>	41
<i>Modesty</i>	43
<i>Credenzas</i>	52
<i>Freestanding Units</i>	57
<i>Bench-Height Storage</i>	59
<i>Combination Storage</i>	62
<i>Marker Board & Tackboard</i>	65
<i>Storage Towers</i>	66
<i>Under Desk Storage</i>	72

Typical – 7'x7' "L" Shape Workstation List Price \$6,048

Quantity	Catalog Number
1	TRGRECS2484
1	TRGULEG24
1	TRGCOS30
1	TRG612LAT20
1	TRGUDPED24
1	TRGTSSDR66

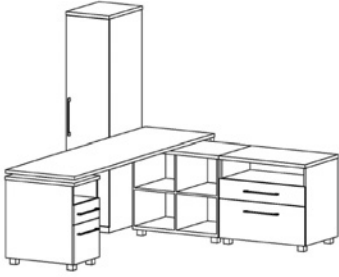

Typical – Mirrored 17' x 9' (8.5' x 9' per station) Workstation List Price \$8,924

Quantity	Catalog Number
1	TRGANGDL309424
1	TRGANGDR249430
2	TRGRECS2078
2	TRGWSBRKTS
2	TRGUDPED20
1	TRGCS6612OSR20
1	TRGCS6612OSL20

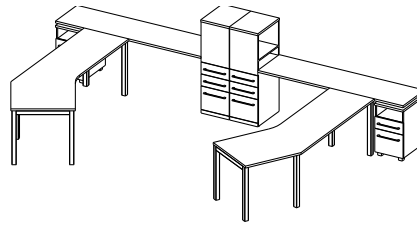

Typical – 6'x8' "L" Shape Workstation List Price \$6,872

Quantity	Catalog Number
1	TRGWEGDL307224
1	TRGCOS30
1	TRG612LAT20
2	TRGTS66OS66

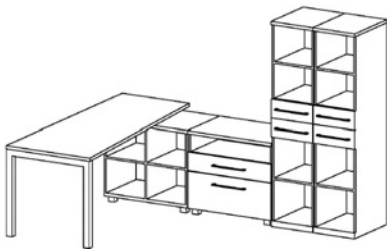

Typical – 10' x 10' (5' x 5' per station) Benching Workstation List Price \$13,336

Quantity	Catalog Number
4	TRGRECD2060
2	TRGBMSM4828
2	TRGCLATOSR45
2	TRGCLATOSL45

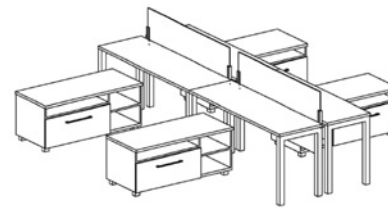

Typical – 8' x 7' "U" Shape Workstation List Price \$6,598

Quantity	Catalog Number
1	TRGEP SR487230
1	TRGESSL487220
1	TRGULEG30
1	TRGUDLAT20
1	SICSP
1	TRG612PED20
1	TRGTSSDL66

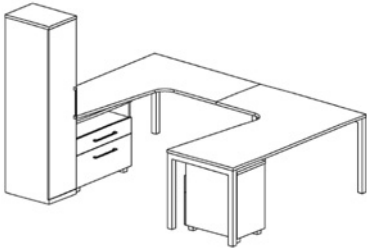

Typical – 6.5' x 16' "L" (6.5' x 8' per station) Shape Workstation List Price \$12,182

Quantity	Catalog Number
2	TRGRECS2478
1	TRGULEG48
2	TRGUDPED24
2	TRGBF2LAT60
1	TRGTSSDR54
1	TRGTSSDL54
1	TRGTMS7813



Typical – Desk Workstation List Price \$4,801

Quantity	Catalog Number
1	TRGRECD2472
1	TRGRECS2072
1	TRGUDPED20
1	TRGUDD20
1	TRGMOD60

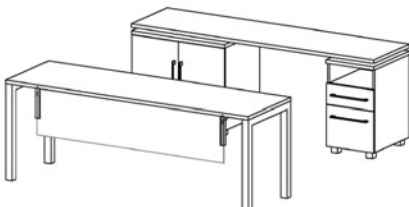

Typical – 8' x 15' (4' x 7.5' per station) 4 Pack Workstation List Price \$13,738

Quantity	Catalog Number
2	TRGEP SL307248
2	TRGEP SR487230
4	TRGWSBRKTS
2	TRGCS6612OSR30
2	TRGCS6612OSL30
2	TRGTMS7213

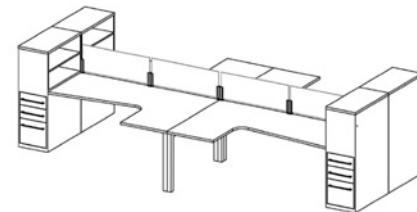

Trig Desking Overview

Trig Desking is a fully integrated line of quality freestanding desks and modular case goods. The collection includes desks, credenzas, conference tables, and bench height, underdesk, combination and tower storage.

Ordering Information

For ease in specifying, Trendway's catalog numbering system uses meaningful characters to convey description, surface type, and size. For example, TRGC2DDCS75 is a Trig Credenza unit with 2 Double Doors, Center Shelves, 75" (1905) wide.

By following the Sample Part Number Example below, you create a Part Number for each product. This Part Number will match your acknowledgement and packaging slip.

When ordering filing and storage units, list the following:

1. Quantity (combine same products)
2. Complete Part Number, see Sample Part Number at the bottom of each page for correct number sequence.
3. For ease of reading, place a period between each option number (TRGCOS30.XZ1.XZ1.XZ4.G)

Trig Key Option

Trig Desking filing and storage units have two lock options to choose from. Units can be randomly keyed (option "R") or they can be key-alike (option "T") for no additional upcharge (see page 9 for more information). When the randomly keyed option "R" is chosen the Trig Desking filing and storage unit will ship with a randomly numbered core/key.

When the key-alike option "T" is chosen the Trig Desking storage unit will ship with a "disposable" core in place of the core/key and the specified Trig Core/Key set(s) will be packaged separately for field installation. The "disposable" core must be field replaced with a Trig Core/Key set in order for the Trig filing and storage unit to lock. The Core/Key set (TLCK) must be ordered separately or by using the Trig Keying order form.

	Catalog Number	Unit/Shelf Color	Top Color	Top Edge Color	Leg Trim Color				
Sample Part Number:	<u>TRGCOS30</u>	<u>.XZ1</u>	<u>.XZ1</u>	<u>.XZ4</u>	<u>.G</u>				
Total Cost \$1114 =	\$1114	+	N/C	+	N/C	+	N/C	+	N/C

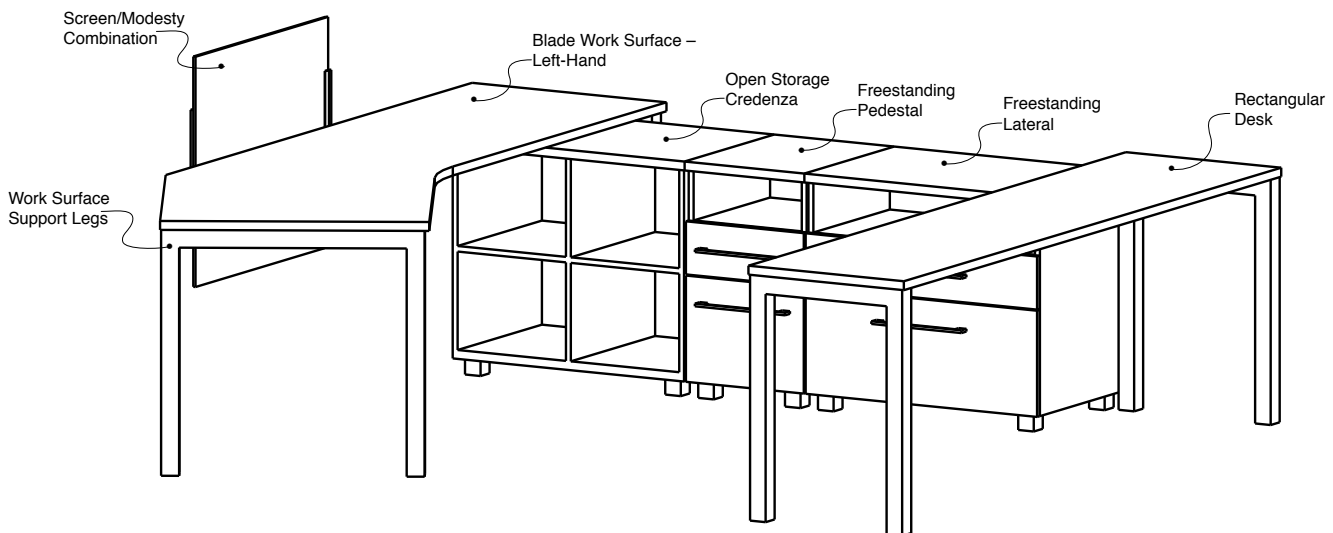

STANDARD FEATURES

Edgebanding

Components are finished with PVC edgebanding. The edgeband color will always match the color of the Thermofused Laminate unless an option pick is noted. All work surfaces and storage component tops have 3mm edgebanding. All remaining components have 1mm edgebanding.

Wire Management

Grommets are available in black or silver. (Optional)

Drawers

All drawers are built for trouble-free performance:

- Chrome plated fully progressive ball bearing suspensions with over-travel on all lateral file drawers with 150 lbs rated load capacity.
- Chrome plated ball bearing suspensions on all box drawers and file drawers with 75 lbs rated load capacity.
- Drawer construction is laminated particleboard sides with MDF bottom.
- Integrated PVC top rails for file storage on lateral drawers and 12" pedestal drawers.
- Interlock standard on all freestanding laterals.

Doors

Storage doors have 95 degree hinges and shock absorbent bumpers.

Leveling Glides

Desks and Table allow up to 1" height adjustment.

Pedestals, Laterals, Credenza, Storage Cabinets and Towers allow up to 1^{5/8}" height adjustment, and are adjustable from inside the storage unit.

Pull Style Options

Trig filing and storage units have four 128mm center applied pull options (Classic, Streamline, and Designer), and one 256mm center pull (Modern). These are all plated nickel finish.

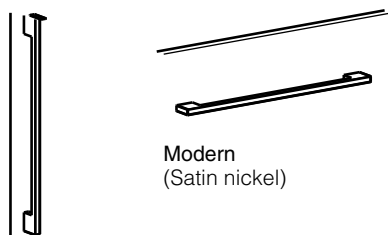
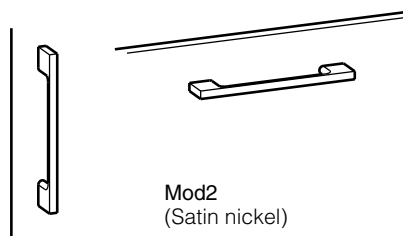
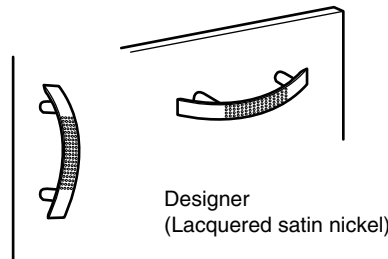
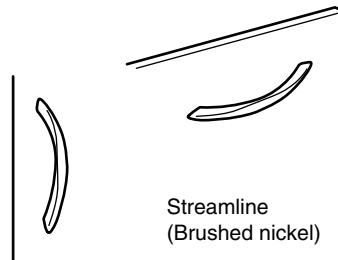
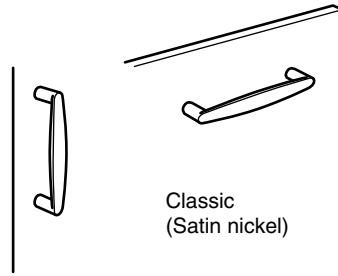

Special Products and Finishes

Please contact Trendway Custom Solutions 1-800-893-8117 for product availability and pricing on non-standard products.

Special finishes (i.e. non-standard) may be ordered at an upcharge. Minimum quantity may be required. Please verify with our Custom Solutions Department. Delivery may take longer depending on the choice of finish or type of material.

SPECIFICATIONS

Load Capacities

All Trig Laminate storage units meet or exceed the following load requirements. For a complete listing of load capacities, contact Trendway Customer Care or visit trenddealer.com

Desks:

5 lbs. (2.3kg) per linear inch, uniformly distributed.

Pedestal:

6" (152) Pedestal Drawer — 20 lbs. (9kg)
12" (305) Pedestal Drawer — 40 lbs. (18kg)
Top — 90 lbs. (41kg)

Laterals:

Drawer — approx. 2.6 lbs. (1.17kg) per linear inch
Top — approx. 4.6 lbs. (2.1kg) per linear inch

Storage Towers:

6" (152) Pedestal Drawer — 20 lbs. (9kg)
12" (305) Pedestal Drawer — 40 lbs. (18kg)
Top — 140 lbs. (64kg)
Unit Shelf — 60 lbs. (27kg)
Unit Bottom — 90 lbs. (41kg)

Double-Door Storage Units:

Shelf — 100 lbs. (45kg)
Top — 160 lbs. (73kg)
Bottom of Cabinet — 160 lbs. (73kg)

Tables:

36" (914) - 60" (1524) — 200 lbs. (276kg)
72"(1829) and longer — 400 lbs. (552kg)

Dimensions

All dimensions listed are nominal unless otherwise noted.

Certification

All components of the Trig Desking offering meet or exceed ANSI/BIFMA X5.6-2016 performance standards unless noted.

Maximum Load Capacity For Any Storage Unit

The maximum load capacity for any storage unit is calculated by multiplying the above stated lbs. for each shelf or drawer that is included with the unit and adding them together (includes the top of the unit and the inside bottom).

Eg: Maximum load capacity for a TRGTSDD66 = load capacity for bottom + 3 shelves + unit top
 = 160 lbs. + 100 lbs. x 3 + 160 lbs.
 = 620 lbs. maximum load

Eg: Maximum load capacity for a TRG612LAT20 = load capacity for drawer x 2 drawers + unit top
 = 2.6 lbs./linear in. x 36" x 2 + 4.6lbs./linear in. x 36"
 = approx. 352 lbs. maximum load (for actual load capacities for each size Trig Laminate Lateral File contact Trendway Customer Care or visit trendealer.com).

Note: The addition of more shelves does not increase the maximum amount a unit can be loaded.

WARNING:

Failure to observe the recommended practices, such as loading beyond listed capacities, will result in unsafe usage conditions and may result in bodily injury or failure of other components.

Any modification to Trendway product will change the criteria referenced above. Trendway will not be responsible for product warranty if modifications are made to the product or if the capacities referenced are exceeded.

Laminate Lateral Files Specifications

Trig Laminate Lateral Files are factory configured for side-to-side filing. If front-to-back filing is desired, the side-to-side filing bars may be removed. No additional parts are necessary to convert drawer to front-to-back filing.

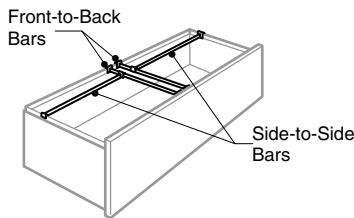

For use with Trig Laminate Lateral Files

Letter Size Filing

30" - Wide & File Center

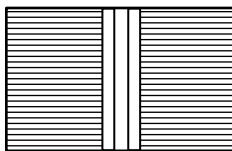

1 Pair Trig Laminate Front-to-Back Filing Bars

Legal Size Filing

30" - Wide & File Center

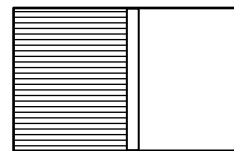

1 Trig Laminate Front-to-Back Filing Bars

Lateral Files

CAUTION: Any freestanding lateral file, if improperly used or loaded, can tip. Since files may contain significant weight, this tipping can result in serious damage and/or personal injury. For proper and safe performance, read and follow instructions provided with each file.

Do not attempt to open more than one lateral file drawer at a time. Do not use drawers as steps. Failure to follow these instructions may cause tipping of cabinet, resulting in personal injury.

Use counterbalance weights whenever lateral files or pedestals are not anchored or ganged back-to-back. Side-by-side ganging does not improve stability.

To avoid tipping, always load bottom drawers before loading top drawer.

Trig offers pre-configured desks with support legs on both ends. Work surfaces with various support options may also be specified.

Specifying Work Surfaces with Support Options

Trig work surfaces are ordered by selecting a work surface shape and then ordering supports separately for the left and right. Storage units can be used as support on both ends of the Rectangle & Wedge work surfaces, but only one end of the Blade, Primary and Secondary work surfaces.

Work Surface With No Supports

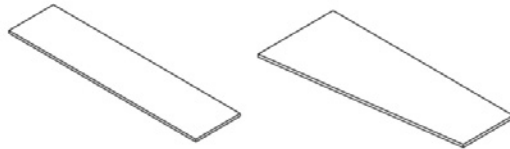

Rectangle

Wedge
Left-Hand

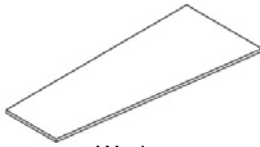

Wedge
Right-Hand

Work Surfaces With One Support

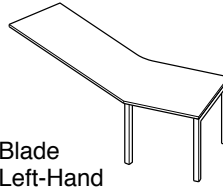

Blade
Left-Hand

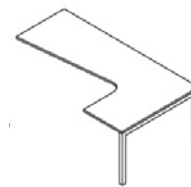

Primary
Left-Hand

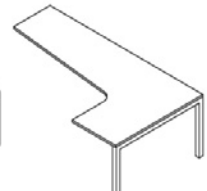

Secondary
Left-Hand

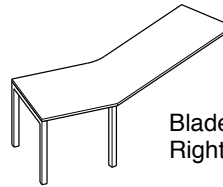

Blade
Right-Hand

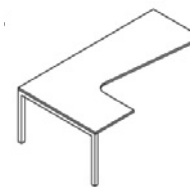

Primary
Right-Hand



Secondary
Right-Hand

Work Surface Support Options

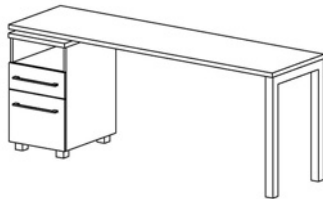

Left-Hand Under Desk
Support Storage

Work Surface
Support Leg

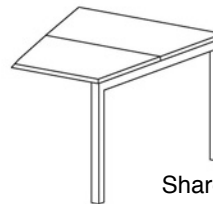

Shared Work Surface Support Leg

- Under desk support storage includes a 1" riser to attach the work surface to the storage unit
- Support leg depth must match the work surface depth

- Shared support legs are utilized when two work surfaces of equal depth are paired together
- Support leg depth must match the work surface depth

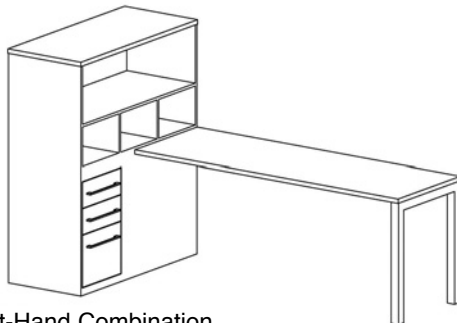

Left-Hand Combination
Storage

Work Surface Support Leg

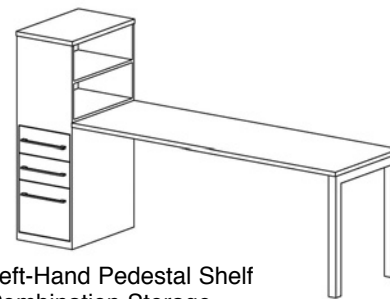

Left-Hand Pedestal Shelf
Combination Storage

Work Surface Support Leg

- Work surface support brackets are used with Combination Storage to mount work surface to unit.
- Support leg depth must match the work surface depth

- Work surface support brackets are used with Combination Storage to mount work surface to unit.
- Support leg depth must match the work surface depth

Creating an “L” shaped office with a return

It is easy to configure “L” shaped offices using these simple guidelines.

Returns can be used on Rectangle, Primary and Secondary Desks

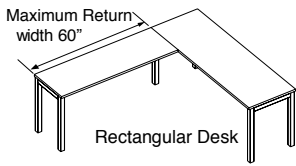

Rectangular Desk

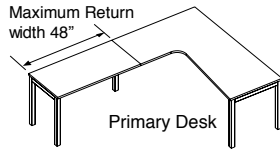

Primary Desk

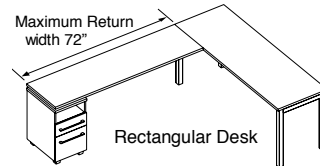

Rectangular Desk

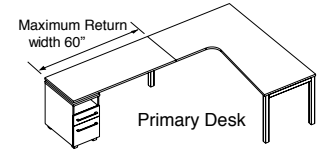

Primary Desk

Return with Flush Plate and Leg Support

Return with Flush Plate and Under Desk Storage or Credenza

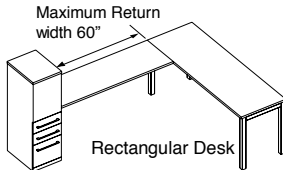

Rectangular Desk

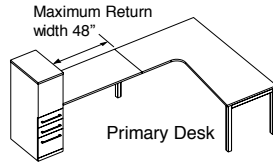

Primary Desk

Return with Flush Plate and Combination Storage

Use the following chart for a quick reference for **Available Work Surface Support Options**

Desks

Support Combinations		Surface Width						
Support 1	Support 2	48"	54"	60"	66"	72"	78"	84"
Leg	Leg	Y	Y	Y	Y	Y	-	-
Leg	Under Desk / Credenza	Y	Y	Y	Y	Y	Y	Y
Leg	Combination Storage	Y	Y	Y	Y	Y	-	-
Under Desk / Credenza	Under Desk / Credenza	Y	Y	Y	Y	Y	Y	Y
Under Desk / Credenza	Combination Storage	Y	Y	Y	Y	Y	Y	Y
Combination Storage	Combination Storage	Y	Y	Y	Y	Y	-	-

Using a Bridge

A Bridge work surface can be used to connect two freestanding rectangular desks.

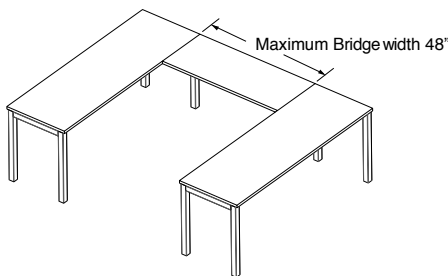

Bridge with Flush Plates

Credenza Support Option

- The support riser attaches the work surface to the storage unit.
- The 1" Support Riser needs to be ordered separately and field installed.
- Credenza top will need to be drilled in the field. Only Under Desk Support Storage comes pre-drilled.
- Field installed riser is 13" long, and when mounted to the bottom of the work surface, it is centered relative to the depth. To give the riser the appropriate support on the credenza, the following chart shows the maximum that the work surface can overhang the storage unit:

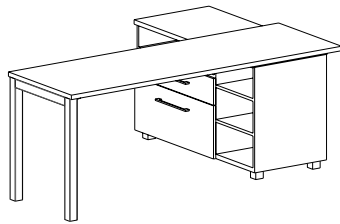
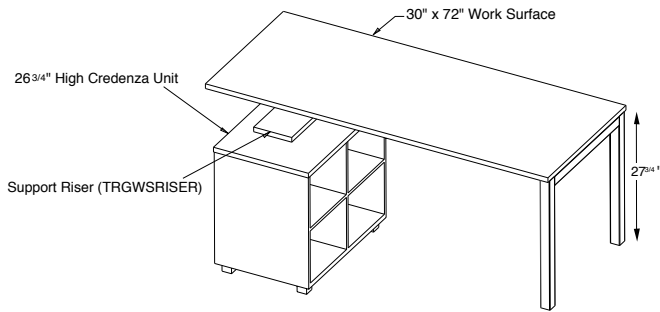

Work Surface Depth	Maximum Overhang
20"	3.5"
24"	5.5"
30"	8.5"

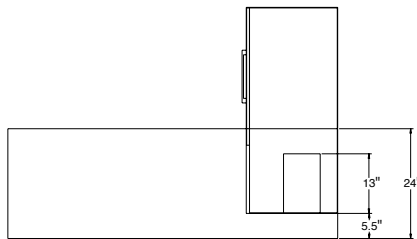

Under Desk Storage Depth for Rectangle, Blade & Secondary Work Surfaces

20" Surface



Surface Depth	Leg Depth	Storage Depth
20"	20"	20"
24"	24"	24"
30"	30"	30"

Under Desk Storage Depth for Wedge Work Surfaces

30" Surface

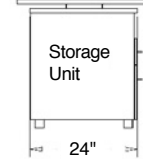

Surface Depth	Leg Depth	Storage Depth
20"	20"	20"
24"	24"	20"
30"	30"	24"

Under Desk Storage Depth for Primary Work Surfaces

30" Surface

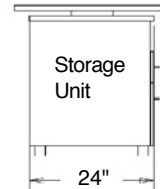

Surface Depth	Leg Depth	Storage Depth
30"	30"	24"

Primary & Secondary Work Surfaces

Primary and Secondary work surfaces are available in 42" and 48" depths.

Primary & Secondary 48"-deep work surfaces can be paired together to create a U-shaped work station. This U-shaped configuration is not recommended for 42"-deep work surfaces as it creates a narrow opening. However, they can be paired with rectangular work surfaces to create L-shaped work stations.

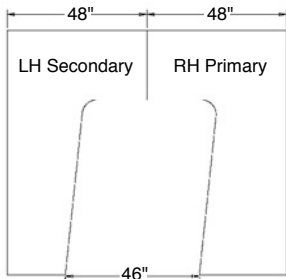

Surface Mount Screen

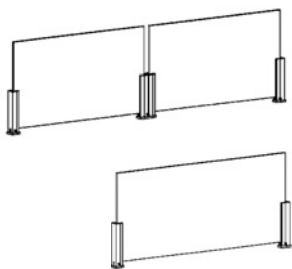

Surface mount screens are used when two work surfaces are positioned back-to-back and no gap exists between them. The base of each post spans seam between two surfaces and mounts on top with two screws. Screens are available in 13" and 19" heights, and lengths that span from 24" to 84" in 6" increments. Screen lengths of 48" and less are a single screen and two vertical posts. Screen lengths greater than 48" are two screens and three posts (center post is shared) see chart below:

Application	Number of Screens	Number of Posts
24" Span	(1) 24"	2
30" Span	(1) 30"	2
36" Span	(1) 36"	2
42" Span	(1) 42"	2
48" Span	(1) 48"	2
54" Span	(1) 24" + (1) 30"	3
60" Span	(2) 30"	3
66" Span	(1) 30" + (1) 36"	3
72" Span	(2) 36"	3
78" Span	(1) 36" + (1) 42"	3
84" Span	(2) 42"	3

(Total length of each screen is .25" shorter than nominal length)

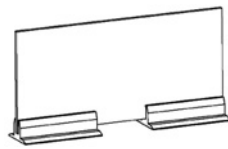

Desk Top Screen

Desk Top Screens are used in benching or multiple-workstation configurations, where surfaces

are positioned adjacent to each other end to end. Screens are available in 8" and 13" heights in each of the following widths: 16", 20", 26", 38" & 44". Screen length selected should be 4" shorter than the depth of the adjacent surfaces.

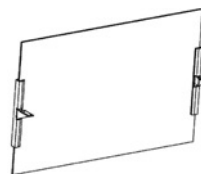

Screen / Modesty Combination

The Screen / Modesty Combinations are mounted 1" off the back edge of the work surface to

provide clearance for cord pass-through. The size needed will depend on the right and left hand support options selected. For work surfaces with legs on both ends, subtract 12" from the width of the top. For work surfaces where underdesk storage or surface support brackets are used with Combination Storage, the screen/modesty width required can be determined by subtracting 12" from the width that remains between the storage units. If the calculated necessary width does not match an available size, choose the next size larger.

Example: 84"-wide work surface with 30"-wide underdesk double door on the left and support legs on the right. The 84" surface minus 30" leaves 54". Subtract 6" from 54" to get 48" for your screen or screen / modesty combination width.

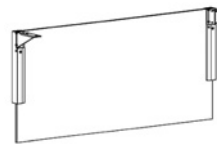

Modesty

The Modesty will be mounted 2" from the back edge of the work surface, and will be sized

to limit physical interference with legs or storage support units. The size needed will depend on the right- and left-hand support options selected. For work surfaces with legs on both ends, the modesty width required can be determined by subtracting 12" from the width of the top. For work surfaces where under desk storage or work surface support brackets are used with Combination Storage, subtract 12" from the width that remains between the storage units. If the calculated necessary width does not match an available size, choose the next size larger.

Example: 84"-wide work surface with 30"- wide under desk double door on the left and support legs on the right. The 84" surface minus 30" leaves 54". Subtract 6" from 54" to get 48" for your modesty width.

Using Support Leg and Storage to Panel Brackets

These brackets are designed to provide stability to panel layouts that otherwise would require return panels. When using these brackets, the panel layout rules for Loaded and Non-loaded panel runs must be followed to ensure a safe installation.

Non-Loaded Panel Runs

A Non-Loaded panel run is defined as having no panel hung components regardless of size or weight. The maximum length of a Non-Loaded panel run is 192" with a maximum of 66" high panels. Two Panel bracket connections, one on each end of the run, are required when used in place of a return panel (with the exception of Parallel-mounted Trig Desk). The Storage to Panel Brackets follow the same layout rules as Support Leg to Panel Brackets for maximum length and height of Non-loaded panel run. Storage units can be side-mounted or back-mounted (Fig. 1).

Fig. 1

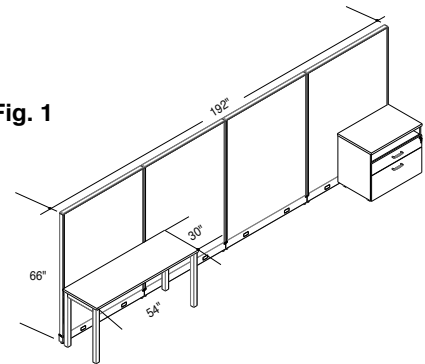

For a perpendicular-mounted Trig Desk the following criteria must be met (Fig. 2):

- The minimum Trig Desk size is 48"W x 20"D.
- The maximum Trig Desk length with 2 Support-Legs is 72". Desks length of 78" and 84" require an under desk storage unit.

Fig. 2

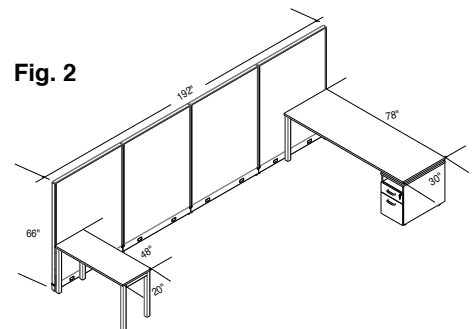

For a parallel-mounted Trig Desk the following criteria must be met:

- The minimum Trig Desk size is 48"W x 30" D if parallel-mounted desk connections are the only panel connections used on one side of a panel run. IF the desk depth is less than 30" then a third panel support is required on the back side of the panel run (Fig 3).
- The maximum Trig Desk length with 2 Support-Legs is 72". Desks length of 78" and 84" require an under-desk storage unit (Fig. 4).

Fig. 3

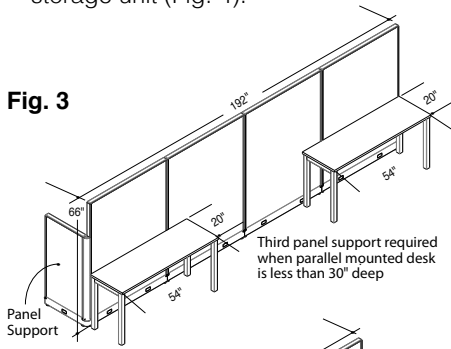
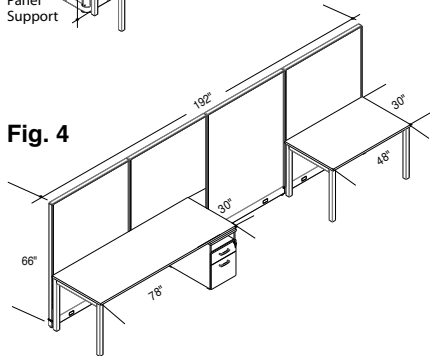

Fig. 4



Loaded Panel Runs

A Loaded panel run is defined as having panel hung components with two or more panels connected in a straight line. The maximum length of a loaded panel run with one panel connection before a panel bracket is needed is 120", and with 2 panel connections is 96". The maximum panel height depends on whether there is a overhead storage on the adjacent panel. Maximum height with no overhead storage on adjacent panel is 66", and with overhead storage on the adjacent panel is 62". "Storage to Panel Brackets follow the same layout rules as Support Leg to Panel Brackets for maximum length and height of a loaded panel run. Storage units can be side-mounted or back-mounted (Fig 5).

Fig. 5

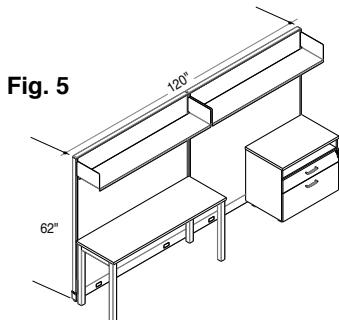

For a perpendicular-mounted Trig Desk the following criteria must be met (Fig. 6):

- The minimum Trig Desk size is 48"W x 20"D.
- The maximum Trig Desk length with 2 Support-Legs is 72". Desks length of 78" and 84" require an under desk storage unit

Fig. 6

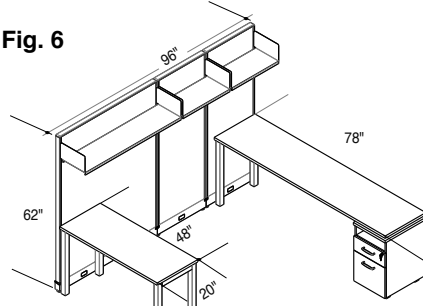

For parallel-mounted Trig Desk the following criteria must be met:

- The minimum Trig Desk size is 48"W x 30" D if parallel-mounted desk connections are the only panel connections used on one side of a panel run. If the desk depth is less than 30" then a third panel support is required on the back side of the panel run (Fig. 7).
- The maximum Trig Desk length with 2 Support-Legs is 72". Desks length of 78" and 84" require an under-desk storage unit (Fig. 8).

Fig. 7

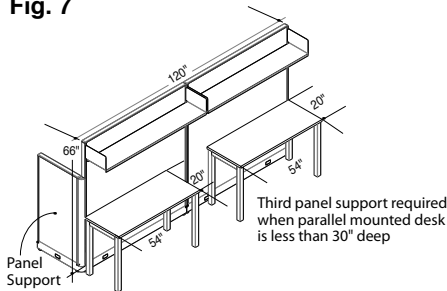
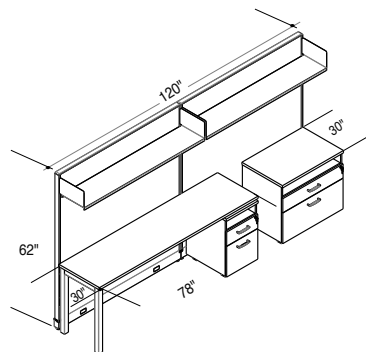

Fig. 8



Grommets

Grommets are optional on all work surfaces. They can be specified in Black or Silver.

Multiple Grommets or a single Power Grommet can be specified for Rectangle and Wedge Surfaces. If the Power Grommet option is selected the Surface will ship with a factory cut opening to house the unit, but the Grommet must be ordered separately.

Note: A power grommet will not fit into a standard grommet opening specified with GY or GY2.

Note: A power grommet cannot be installed in a worksurface with a 26.75" high storage unit below.

The following drawings show standard Grommet locations.

Code	Position
GY	Single Grommet, centered left to right, 4" from the back of the table top.
GY2	Pair of Grommets, 14" to the center from each end, and 4" from the back of the table top
PNDR	One cutout for the Power Grommet 14" from the right edge of the top, and 4 3/8" in from the back edge.
PNDL	One cutout for the Power Grommet 14" from the left edge of the top, and 4 3/8" in from the back edge.

Grommet Dimensions

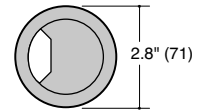

Power Grommet Locations

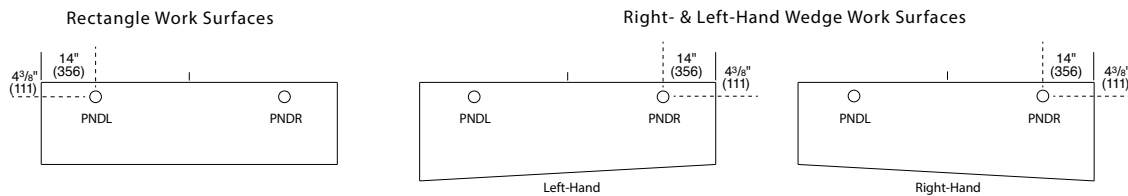

Standard Grommet Locations

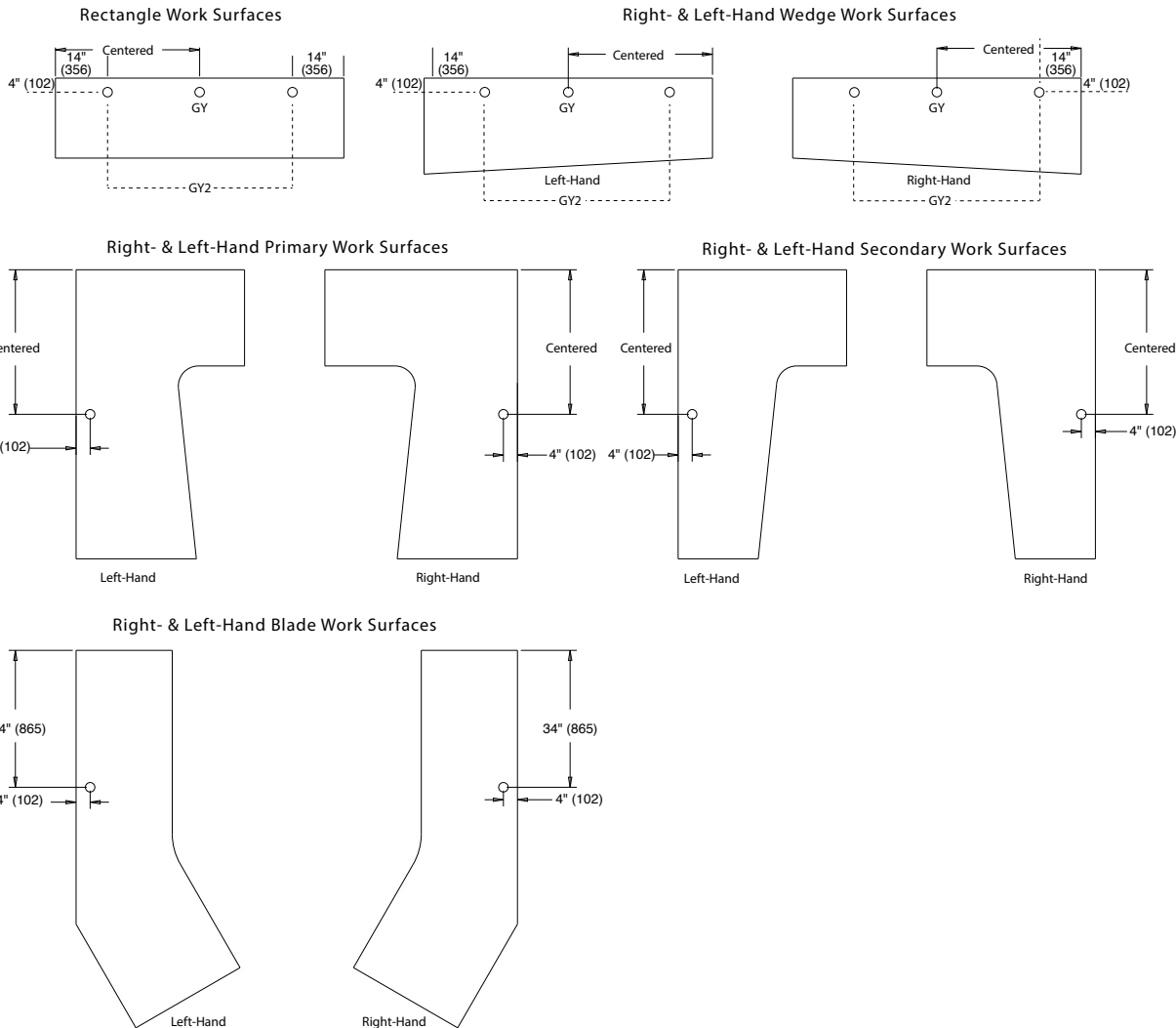

Rectangular Desks

Trig Rectangular desks are constructed of 1"-thick Thermofused Laminate with a 3mm vinyl edge band. They are available with an optional black or silver grommet and/or a factory-cut opening for a power grommet. See planning section for standard grommet / power locations. Desks include two work surface support legs for right- and left-hand support. Additional accessories include field installed Screens, Modesties, Monitor Arms and Personal Task Lights.

Power Grommets are ordered separately. They will only fit into an opening that has been specified PNDR(L). See page 87 for details.

Note: For 36" wide surfaces with the PNDR, PNDL or GY2 option, the Trig Power sets, TRGDR12, should not be used.

Trig Rectangular Desk

Dimensions		List Price Thermofused Grade		Catalog Number	Power Grommet Option	Non-Power Grommet Option	Grommet Color	Top Color	Top Edge Color	Leg Trim Color
Depth	Width	1	2							
20" (508)	36" (914)	\$882	\$897	TRGRECD2036	NN No Power	No Cost GN No Grommet	GB Black GS Silver	Thermo-fused Laminate (See Surface Materials Page 10)	Thermo-fused Laminate (See Surface Materials Page 10)	Standard Finish No Cost Premium Finish + \$36
	42" (1067)	887	903	TRGRECD2042						
	48" (1372)	893	908	TRGRECD2048						
	54" (1372)	998	1014	TRGRECD2054						
	60" (1524)	1003	1018	TRGRECD2060						
	66" (1676)	1026	1041	TRGRECD2066						
	72" (1829)	1070	1085	TRGRECD2072						
24" (610)	36" (914)	\$925	\$940	TRGRECD2436	PNDL Power Left	GY2 Two Grommets (Not available with PNDR or PNDL)	GB Black GS Silver	Thermo-fused Laminate (See Surface Materials Page 10)	Thermo-fused Laminate (See Surface Materials Page 10)	Standard Finish No Cost Premium Finish + \$36
	42" (1067)	930	946	TRGRECD2442						
	48" (1219)	936	951	TRGRECD2448						
	54" (1372)	1026	1041	TRGRECD2454						
	60" (1524)	1031	1047	TRGRECD2460						
	66" (1676)	1041	1057	TRGRECD2466						
	72" (1829)	1070	1085	TRGRECD2472						
30" (762)	36" (914)	\$1015	\$1030	TRGRECD3036			GB Black GS Silver	Thermo-fused Laminate (See Surface Materials Page 10)	Thermo-fused Laminate (See Surface Materials Page 10)	Standard Finish No Cost Premium Finish + \$36
	42" (1067)	1020	1036	TRGRECD3042						
	48" (1219)	1026	1041	TRGRECD3048						
	54" (1372)	1082	1112	TRGRECD3054						
	60" (1524)	1092	1122	TRGRECD3060						
	66" (1676)	1114	1144	TRGRECD3066						
	72" (1829)	1141	1171	TRGRECD3072						

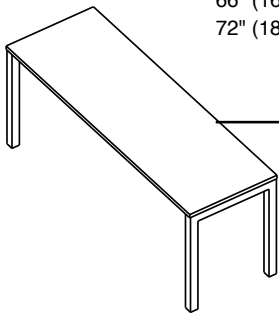

Build your complete Part Number here:

Sample Part Number:

TRGRECD2048	.NN	.GN	N/A	.XZ4	.XZ2	.K
-------------	-----	-----	-----	------	------	----

Total Cost \$893 =

\$893	+	N/C	+	N/C	+	N/C	+	N/C	+	N/C
-------	---	-----	---	-----	---	-----	---	-----	---	-----

Wedge Desks

Trig Wedge desks are constructed of 1"-thick Thermofused Laminate with a 3mm vinyl edge band. They are available with an optional black or silver grommet and/or a factory-cut opening for a power grommet. See planning section for standard grommet / power locations. Desks include two work surface support legs for right- and left-hand support. Additional accessories include field installed Screens, Modesties, Monitor Arms and Personal Task Lights.

Power Grommets are ordered separately. They will only fit into an opening that has been specified PNDR(L). See page 87 for details.

Trig Wedge Desk – Right-Hand

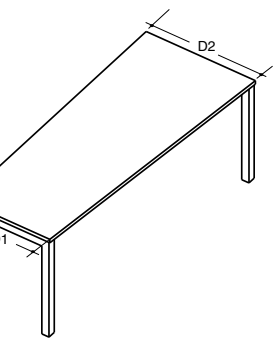
Depth1	Dimensions		List Price		Catalog Number	Power Grommet Option	Non-Power Grommet Option	Grommet Color	Top Color	Top Edge Color	Leg Trim Color	
	Width	Depth2	1	Grade 2								
20" (508)	54" (1372)	24" (610)	\$1048	\$1063	TRGWEGDR205424	NN	No Cost	GB	Thermo-fused Laminate (See Surface Materials Page 10)	Thermo-fused Laminate (See Surface Materials Page 10)	Standard Finish No Cost	
	60" (1524)		1070	1085	TRGWEGDR206024	No	GN	GS Silver				
	66" (1676)		1092	1107	TRGWEGDR206624	Power	No Grommet					
	72" (1829)		1109	1125	TRGWEGDR207224	PNDR	GY					1 Grommet
20" (508)	54" (1372)	30" (762)	\$1054	\$1084	TRGWEGDR205430	PNDL	GY2	2 Grommets (Not available if PNDR or PNDL selected)			Premium Finish + \$36	
	60" (1524)		1082	1112	TRGWEGDR206030							
	66" (1676)		1105	1135	TRGWEGDR206630							
	72" (1829)		1120	1150	TRGWEGDR207230							
24" (610)	54" (1372)	30" (762)	\$1054	\$1084	TRGWEGDR245430							
	60" (1524)		1082	1112	TRGWEGDR246030							
	66" (1676)		1105	1135	TRGWEGDR246630							
	72" (1829)		1120	1150	TRGWEGDR247230							
						Build your complete Part Number here:						
						---	--	--	--	--	--	--

Sample Part Number:

TRGWEGDR205424	.NN	.GY	.GB	.XZ2	.XZ4	.K
-----------------------	------------	------------	------------	-------------	-------------	-----------

Total Cost \$1048 =

\$1048	+	N/C	+	N/C	+	N/C	+	N/C	+	N/C	+	N/C
--------	---	-----	---	-----	---	-----	---	-----	---	-----	---	-----

Wedge Desks

Trig Wedge desks are 1"-thick Thermofused Laminate with a 3mm vinyl edge band.

They are available with an optional black or silver grommet and/or a factory-cut opening for a power grommet. See grommet information in the planning section for standard grommet locations.

Desks include two work surface support legs for the right- and left-hand support. Additional accessories include field-installed screens, modesties, Monitor Arms and Personal Task Lights.

Power Grommets are ordered separately. They will only fit into an opening that has been specified PNDR(L). See page 87 for details.

Trig Wedge Desk – Left-Hand

Depth1	Dimensions		List Price Thermofused Grade		Catalog Number	Power Grommet Option	Non-Power Grommet Option	Grommet Color	Top Color	Top Edge Color	Leg Trim Color
	Width	Depth 2	1	2							
24" (610)	54" (1372)	20" (508)	\$1048	\$1063	TRGWEGDL245420	NN No Power PNDR Power Right	No Cost GN No Grommet GY 1 Grommet	GB Black GS Silver	Thermo-fused Laminate (See Surface Materials Page 10)	Thermo-fused Laminate (See Surface Materials Page 10)	Standard Finish No Cost Premium Finish + \$36
	60" (1524)		1070	1085	TRGWEGDL246020						
	66" (1676)		1092	1107	TRGWEGDL246620						
	72" (1829)		1109	1125	TRGWEGDL247220						
30" (762)	54" (1372)	20" (508)	\$1054	\$1084	TRGWEGDL305420	PNDR Power Left	GY2 2 Grommets (Not available if PNDR or PNDR selected)				
	60" (1524)		1082	1112	TRGWEGDL306020						
	66" (1676)		1105	1135	TRGWEGDL306620						
	72" (1829)		1120	1150	TRGWEGDL307220						
30" (762)	54" (1372)	24" (610)	\$1054	\$1084	TRGWEGDL305424						
	60" (1524)		1082	1112	TRGWEGDL306024						
	66" (1676)		1105	1135	TRGWEGDL306624						
	72" (1829)		1120	1150	TRGWEGDL307224						
Build your complete Part Number here:					_____	__	__	__	_____	_____	__

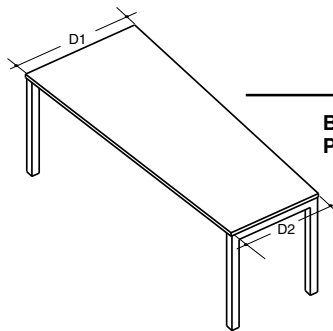

Sample Part Number:

TRGWEGDL245420	.NN	.GN	N/A	.XZ2	.XZ4	.K
_____	__	__	__	__	__	__

Total Cost \$1048 =

\$1048	+	N/C	+	N/C	+	N/C	+	N/C	+	N/C	+	N/C
--------	---	-----	---	-----	---	-----	---	-----	---	-----	---	-----

Blade Desks

Trig Blade desks are 1"-thick Thermofused Laminate with a 3mm vinyl edge band.

Optional grommet available in black or silver. See grommet information in the planning section for standard grommet locations.

Desks include two work surface support legs for the right- and left-hand support. Additional accessories include field-installed screens, modesties, Monitor Arms and Personal Task Lights.

Trig Blade Desk – Right-Hand

Depth1	Dimensions		List Price Thermofused Grade		Catalog Number	Grommet	Grommet Color	Top Color	Top Edge Color	Leg Trim Color
	Width	Depth 2	1	2						
24" (610)	94" (2388)	30" (914)	\$1460	\$1531	TRGANGDR249430	No Cost GN No Grommet GY Grommet	GB Black GS Silver	Thermo-fused Laminate (See Surface Materials Page 10)	Thermo-fused Laminate (See Surface Materials Page 10)	Standard Finish No Cost Premium Finish + \$36

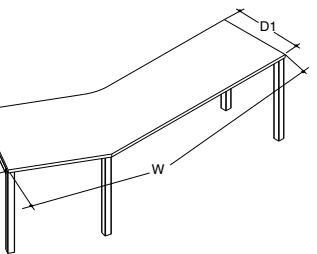

Trig Blade Desk – Left-Hand

Depth1	Dimensions		List Price Thermofused Grade		Catalog Number
	Width	Depth 2	1	2	
30" (914)	94" (2388)	24" (610)	\$1460	\$1531	TRGANGDL309424

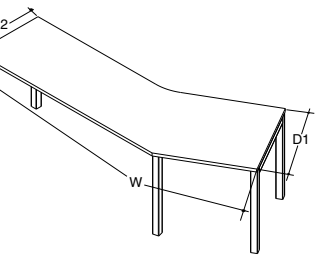

Build your complete Part Number here:

-----	--	--	---	---	---
-------	----	----	-----	-----	-----

Sample Part Number:

TRGANGDR249430	.GN	N/A	.XZ2	.XZ4	.K
----------------	-----	-----	------	------	----

Total Cost \$1460 =

\$1460	+	N/C	+	N/C	+	N/C	+	N/C	+	N/C
--------	---	-----	---	-----	---	-----	---	-----	---	-----

Primary Desks

Trig Primary desks are 1"-thick Thermofused Laminate with a 3mm vinyl edge band.

Optional grommet available in black or silver. See grommet information in the planning section for standard grommet locations.

Desks include two work surface support legs for the right- and left-hand support. Additional accessories include field-installed screens, modesties, Monitor Arms and Personal Task Lights.

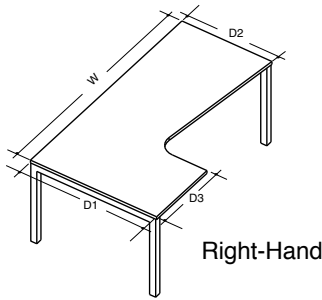

Right-Hand

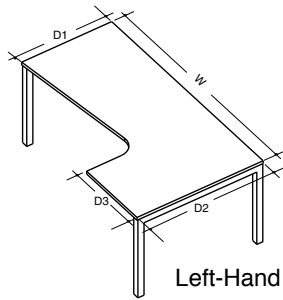

Left-Hand

Trig Primary Desk – Right-Hand

Dimensions				List Price Thermofused Grade		Catalog Number	Grommet	Grommet Color	Top Color	Top Edge Color	Leg Trim Color			
Depth 1	Width	Depth 2	Depth 3	1	2									
42" (1067)	54" (1372)	30" (762)	24" (610)	\$1428	\$1479	TRGEPDR425430	No Cost GN No Grommet GY Grommet	GB Black	Thermo-fused Laminate (See Surface Materials Page 10)	Thermo-fused Laminate (See Surface Materials Page 10)	Standard Finish No Cost			
	60" (1524)	30" (762)		1428	1479	TRGEPDR426030								
	66" (1676)	30" (762)		1438	1489	TRGEPDR426630								
	72" (1829)	30" (762)		1438	1489	TRGEPDR427230								
48" (1219)	54" (1372)	30" (762)	24" (610)	\$1438	\$1489	TRGEPDR485430		GY Grommet			GS Silver	Thermo-fused Laminate (See Surface Materials Page 10)	Thermo-fused Laminate (See Surface Materials Page 10)	Premium Finish + \$36
	60" (1524)	30" (762)		1438	1489	TRGEPDR486030								
	66" (1676)	30" (762)		1450	1501	TRGEPDR486630								
	72" (1829)	30" (762)		1450	1501	TRGEPDR487230								

Trig Primary Desk – Left-Hand

Dimensions				List Price Thermofused Grade		Catalog Number
Depth 1	Width	Depth 2	Depth 3	1	2	
30" (762)	54" (1372)	42" (1067)	24" (610)	\$1428	\$1479	TRGEPDL305442
30" (762)	60" (1524)			1428	1479	TRGEPDL306042
30" (762)	66" (1676)			1438	1489	TRGEPDL306642
30" (762)	72" (1829)			1438	1489	TRGEPDL307242
30" (762)	54" (1372)	48" (1219)	24" (610)	\$1438	\$1489	TRGEPDL305448
30" (762)	60" (1524)			1438	1489	TRGEPDL306048
30" (762)	66" (1676)			1450	1501	TRGEPDL306648
30" (762)	72" (1829)			1450	1501	TRGEPDL307248

Build your complete Part Number here:

Sample Part Number:

TRGEPDR425430	.GN	N/A	.XZ2	.XZ4	.K
---------------	-----	-----	------	------	----

Total Cost \$1428 =

\$1428	+	N/C	+	N/C	+	N/C	+	N/C	+	N/C
--------	---	-----	---	-----	---	-----	---	-----	---	-----

Secondary Desks

Trig Secondary desks are 1"-thick Thermofused Laminate with a 3mm vinyl edge band.

Optional grommet available in black or silver. See grommet information in the planning section for standard grommet locations.

Desks include two work surface support legs for the right- and left-hand support. Additional accessories include field-installed screens, modesties, Monitor Arms and Personal Task Lights.

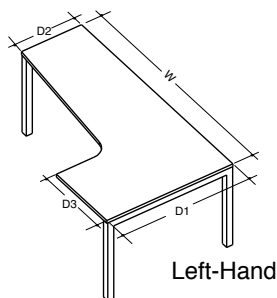
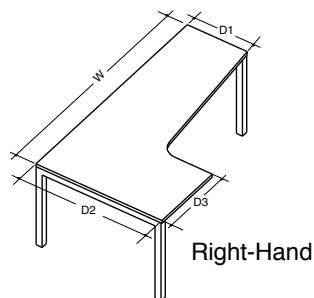

Trig Secondary Desk – Right-Hand

Depth 1	Dimensions			List Price Thermofused Grade		Catalog Number	Grommet	Grommet Color	Top Color	Top Edge Color	Leg Trim Color
	Width	Depth 2	Depth 3	1	2						
20" (508)	54" (1372)	42" (1067)	24" (610)	\$1416	\$1467	TRGESDR205442	No Cost GN No Grommet GY Grommet	GB Black GS Silver	Thermo-fused Laminate (See Surface Materials Page 10)	Thermo-fused Laminate (See Surface Materials Page 10)	Standard Finish No Cost Premium Finish + \$36
	60" (1524)			1416	1467	TRGESDR206042					
	66" (1676)			1428	1479	TRGESDR206642					
	72" (1829)			1428	1479	TRGESDR207242					
20" (508)	54" (1372)	48" (1219)	24" (610)	\$1428	\$1479	TRGESDR205448					
	60" (1524)			1428	1479	TRGESDR206048					
	66" (1676)			1438	1489	TRGESDR206648					
	72" (1829)			1438	1489	TRGESDR207248					

Trig Secondary Desk – Left-Hand

Depth 1	Dimensions			List Price Thermofused Grade		Catalog Number
	Width	Depth 2	Depth 3	1	2	
42" (1067)	54" (1372)	20" (508)	24" (610)	\$1416	\$1467	TRGESDL425420
	60" (1524)			1416	1467	TRGESDL426020
	66" (1676)			1428	1479	TRGESDL426620
	72" (1829)			1428	1479	TRGESDL427220
48" (1219)	54" (1372)	20" (508)	24" (610)	\$1428	\$1479	TRGESDL485420
	60" (1524)			1428	1479	TRGESDL486020
	66" (1676)			1438	1489	TRGESDL486620
	72" (1829)			1438	1489	TRGESDL487220

Build your complete Part Number here:

Sample Part Number:

Total Cost \$1416 =

TRGESDL425420	.GY	.GB	.XZ2	.XZ4	.K					
\$1416	+	N/C	+	N/C	+	N/C	+	N/C	+	N/C

Rectangular Work Surface
 Trig Rectangular Work Surfaces are constructed of 1"-thick Thermofused Laminate with a 3mm vinyl edge band. They are available with an optional black or silver grommet and/or a factory-cut opening for a power grommet. See planning section for standard grommet / power locations. Work Surfaces do not include supports. Order supports separately. Additional

accessories include field-installed Screens, Modesties, Monitor Arms and Personal Task Lights.

Note: For 78" and 84" wide work surfaces, support is required under one end using under desk storage or a Credenza with riser.

Power Grommets are ordered separately. They will only fit into an opening that has been specified

PNDR(L). See page 87 for details.

Note: For 36" wide surfaces with the PNDR, PNDL or GY2 option, the Trig Power sets, TRGDR12, should not be used.

Trig Rectangular Work Surface

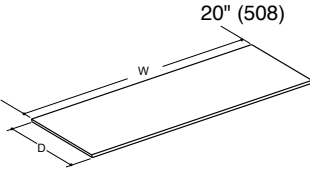
Dimensions Depth	Width	List Price Thermofused Grade		Catalog Number	Power Grommet Option	Non-Power Grommet Option	Grommet Color	Top Color	Top Edge Color
		1	2						
 20" (508)	24" (610)	\$179	\$194	TRGRECS2024	NN	No Cost	GB	Thermo-fused Laminate (See Surface Materials Page 10)	Thermo-fused Laminate (See Surface Materials Page 10)
	30" (762)	184	200	TRGRECS2030	No Power	GN	Black		
	36" (914)	190	205	TRGRECS2036		No Grommet			
	42" (1067)	196	212	TRGRECS2042			GS		
	48" (1219)	202	217	TRGRECS2048	PNDR		Silver		
	54" (1372)	306	322	TRGRECS2054	Power Right (Not available on 24" and 30" wide)	GY			
	60" (1524)	312	327	TRGRECS2060		1 Grommet			
	66" (1676)	335	350	TRGRECS2066		GY2			
	72" (1829)	378	393	TRGRECS2072		2 Grommets (Not available if PNDR or PNDL selected)			
	78" (1981)	401	431	TRGRECS2078					
24" (610)	24" (610)	\$222	\$237	TRGRECS2424	PNDR				
	30" (762)	227	243	TRGRECS2430	Power Left (Not available on 24" and 30" wide)				
	36" (914)	233	248	TRGRECS2436					
	42" (1067)	238	254	TRGRECS2442					
	48" (1219)	245	260	TRGRECS2448					
	54" (1372)	335	350	TRGRECS2454					
	60" (1524)	341	356	TRGRECS2460					
	66" (1676)	350	366	TRGRECS2466					
	72" (1829)	378	393	TRGRECS2472					
	78" (1981)	429	458	TRGRECS2478					
30" (762)	24" (610)	\$289	\$304	TRGRECS3024					
	30" (762)	294	310	TRGRECS3030					
	36" (914)	300	315	TRGRECS3036					
	42" (1067)	305	321	TRGRECS3042					
	48" (1219)	312	327	TRGRECS3048					
	54" (1372)	368	398	TRGRECS3054					
	60" (1524)	378	408	TRGRECS3060					
	66" (1676)	401	431	TRGRECS3066					
	72" (1829)	429	458	TRGRECS3072					
	78" (1981)	489	519	TRGRECS3078					
84" (2134)	520	550	TRGRECS3084						
Build your complete Part Number here:				-----	--	--	--	---	---

Sample Part Number:

TRGRECS2048	.NN	.GN	N/A	.XZ4	.XZ2
-------------	-----	-----	-----	------	------

Total Cost \$202 =

\$202	+	N/C	+	N/C	+	N/C	+	N/C	+	N/C
-------	---	-----	---	-----	---	-----	---	-----	---	-----

Wedge Work Surface

Trig Wedge Work Surfaces are constructed of 1"-thick Thermofused Laminate with a 3mm vinyl edge band. They are available with an optional black or silver grommet and/or a factory-cut opening for a power grommet. See planning section for standard grommet / power locations. Work Surfaces do not include supports. Supports must be specified separately. Additional accessories include field-installed Screens, Modesties, Monitor Arms and Personal Task Lights.

Note: For 78" and 84" wide work surfaces, support is required on under end using under desk storage or a Credenza with riser.

Power Grommets are ordered separately. They will only fit into an opening that has been specified PNDR(L). See page 87 for details.

Trig Wedge Work Surface – Right-Hand

Depth1	Dimensions		List Price Thermofused Grade		Catalog Number	Power Grommet Option	Non-Power Grommet Option	Grommet Color	Top Color	Top Edge Color
	Width	Depth 2	1	2						
20" (508)	54" (1372)	24" (610)	\$355	\$370	TRGWEGRSR205424	NN No Power PNDR Power Right	No Cost GN No Grommet GY 1 Grommet	GB Black GS Silver	Thermo-fused Laminate (See Surface Materials Page 10)	Thermo-fused Laminate (See Surface Materials Page 10)
	60" (1524)		378	393	TRGWEGRSR206024					
	66" (1676)		401	416	TRGWEGRSR206624					
	72" (1829)		419	434	TRGWEGRSR207224					
	78" (1981)		475	504	TRGWEGRSR207824					
	84" (2134)		512	542	TRGWEGRSR208424					
20" (508)	54" (1372)	30" (762)	\$355	\$385	TRGWEGRSR205430	PNDR Power Left	GY2 2 Grommets (Not available if PNDR or PNDR selected)			
	60" (1524)		378	408	TRGWEGRSR206030					
	66" (1676)		401	431	TRGWEGRSR206630					
	72" (1829)		419	448	TRGWEGRSR207230					
	78" (1981)		475	504	TRGWEGRSR207830					
	84" (2134)		512	542	TRGWEGRSR208430					
24" (610)	54" (1372)	30" (762)	\$355	\$385	TRGWEGRSR245430					
	60" (1524)		378	408	TRGWEGRSR246030					
	66" (1676)		401	431	TRGWEGRSR246630					
	72" (1829)		419	448	TRGWEGRSR247230					
	78" (1981)		475	504	TRGWEGRSR247830					
	84" (2134)		512	542	TRGWEGRSR248430					
Build your complete Part Number here:					-----	--	--	--	---	---

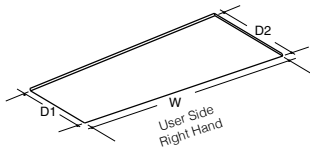

Sample Part Number:

TRGWEGRSR205424	.NN	.GN	N/A	.XZ2	.XZ4
-----------------	-----	-----	-----	------	------

Total Cost \$355 =

\$355	+	N/C	+	N/C	+	N/C	+	N/C	+	N/C
-------	---	-----	---	-----	---	-----	---	-----	---	-----

Wedge Work Surface

Trig Wedge Work Surfaces are 1"-thick Thermofused Laminate with a 3mm vinyl edge band.

They are available with an optional black or silver grommet and/or a factory-cut opening for a power grommet. See grommet information in the planning section for standard grommet locations.

Work Surfaces do not include supports. Order supports separately. Additional accessories include field-installed screens, modesties, Monitor Arms and Personal Task Lights.

Note: For 78" and 84" wide work surfaces, support is required on one end using under desk storage or a Credenza with riser.

Power Grommets are ordered separately. They will only fit into an opening that has been specified PNDR(L). See page 87 for details.

Trig Wedge Work Surface – Left-Hand

Depth1	Dimensions		List Price Thermofused Grade		Catalog Number	Power Grommet Option	Non-Power Grommet Option	Grommet Color	Top Color	Top Edge Color
	Width 1	Depth 2	1	2						
24" (610)	54" (1372)	20" (508)	\$355	\$370	TRGWEGL245420	NN No Power PNDR Power Right	No Cost GN No Grommet GY 1 Grommet	GB Black GS Silver	Thermo-fused Laminate (See Surface Materials Page 10)	Thermo-fused Laminate (See Surface Materials Page 10)
	60" (1524)		378	393	TRGWEGL246020					
	66" (1676)		401	416	TRGWEGL246620					
	72" (1829)		419	434	TRGWEGL247220					
	78" (1981)		475	504	TRGWEGL247820					
	84" (2134)		512	542	TRGWEGL248420					
30" (762)	54" (1372)	20" (508)	\$355	\$385	TRGWEGL305420	PNDL Power Left	GY2 2 Grommets (Not available if PNDR or PNDL selected)			
	60" (1524)		378	408	TRGWEGL306020					
	66" (1676)		401	431	TRGWEGL306620					
	72" (1829)		419	448	TRGWEGL307220					
	78" (1981)		475	504	TRGWEGL307820					
	84" (2134)		512	542	TRGWEGL308420					
30" (762)	54" (1372)	24" (610)	\$355	\$385	TRGWEGL305424					
	60" (1524)		378	408	TRGWEGL306024					
	66" (1676)		401	431	TRGWEGL306624					
	72" (1829)		419	448	TRGWEGL307224					
	78" (1981)		475	504	TRGWEGL307824					
	84" (2134)		512	542	TRGWEGL308424					

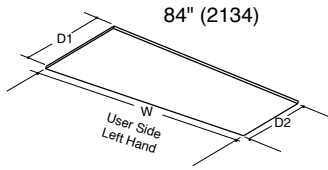

Build your complete Part Number here:

Sample Part Number:

TRGWEGL245420	.GY	.GS	.XZ2	.XZ4
---------------	-----	-----	------	------

Total Cost \$355 =

\$355	+	N/C	+	N/C	+	N/C	+	N/C
-------	---	-----	---	-----	---	-----	---	-----

Blade Work Surface

Trig Blade Work Surface are 1"-thick Thermofused Laminate with a 3mm vinyl edge band.

Optional grommet available in black or silver. See grommet information in the planning section for standard grommet locations.

Right-handed Blade Work Surfaces include a support leg for Depth 2. Support for Depth 1 must be ordered separately.

Left-handed Blade Work Surfaces include a support leg for Depth 1. Support for Depth 2 must be ordered separately.

Trig Blade Work Surface – Right-Hand

Depth1	Dimensions Width	Depth 2	List Price Thermofused Grade		Catalog Number	Grommet	Grommet Color	Top Color	Top Edge Color	Leg Trim Color
			1	2						
24" (610)	94" (2388)	30" (914)	\$1114	\$1184	TRGANGSR249430	No Cost GN No Grommet GY Grommet	GB Black GS Silver	Thermo-fused Laminate (See Surface Materials Page 10)	Thermo-fused Laminate (See Surface Materials Page 10)	Standard Finish No Cost Premium Finish + \$19

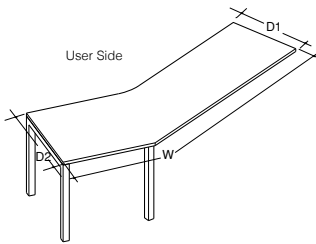

Trig Blade Work Surface – Left-Hand

Depth1	Dimensions Width	Depth 2	List Price Thermofused Grade		Catalog Number
			1	2	
30" (914)	94" (2388)	24" (610)	\$1114	\$1184	TRGANGSL309424

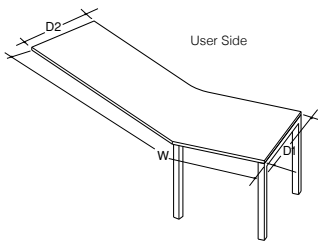

Build your complete Part Number here:

---	---	---	---	---	---
-----	-----	-----	-----	-----	-----

Sample Part Number:

TRGANGSR249430	.GN	N/A	.XZ2	.XZ4	.K
----------------	-----	-----	------	------	----

Total Cost \$1114 =

\$1114	+	N/C	+	N/C	+	N/C	+	N/C	+	N/C
--------	---	-----	---	-----	---	-----	---	-----	---	-----

Primary Work Surface

Trig Primary Work Surfaces are 1"-thick Thermofused Laminate with a 3mm vinyl edge band.

Optional grommet available in black or silver. See grommet information in the planning section for standard grommet locations.

Right-Handed Primary Work Surfaces include a support leg for Depth 1. Support for Depth 2 must be ordered separately.

Left-handed Primary Work Surfaces include a support leg for Depth 2. Support for Depth 1 must be ordered separately.

Primary Work Surfaces can be used alone or paired with Secondary Work Surfaces to create a U-shape work station. Primary Work Surfaces are available in right- and left-hand versions. Right-hand Primary surfaces are paired with left-hand Secondary surfaces to form a U-shaped work station. Or left-hand Primary surfaces are paired with right-hand Secondary surfaces to form the mirrored affect.

If Primary Work Surfaces are paired with Secondary Work Surfaces to create U-shaped work stations, a Flush Support Plate (SICSP) must be ordered to connect the two work surfaces together.

(See Planning Guide for limitations)

Additional accessories include field-installed screens, modesties, Monitor Arms and Personal Task Lights.

Note: For 78" and 84" wide work surfaces, support is required on one end using under desk storage or a Credenza with riser.

Trig Primary Work Surface – Right-Hand

Depth 1	Dimensions			List Price		Catalog Number	Grommet	Grommet Color	Top Color	Top Edge Color	Leg Trim Color
	Width	Depth 2	Depth 3	Thermofused Grade 1	Thermofused Grade 2						
42" (1067)	54" (1372)	30" (762)	24" (610)	\$1070	\$1120	TRGEPSR425430	No Cost GN No Grommet GY Grommet	GB Black GS Silver	Thermo-fused Laminate (See Surface Materials Page 10)	Thermo-fused Laminate (See Surface Materials Page 10)	Standard Finish No Cost Premium Finish + \$19
	60" (1524)	30" (762)		1070	1120	TRGEPSR426030					
	66" (1676)	30" (762)		1082	1133	TRGEPSR426630					
	72" (1829)	30" (762)		1082	1133	TRGEPSR427230					
	78" (1981)	30" (762)		1238	1309	TRGEPSR427830					
	84" (2134)	30" (762)		1254	1324	TRGEPSR428430					
48" (1219)	54" (1372)	30" (762)	24" (610)	\$1082	\$1133	TRGEPSR485430					
	60" (1524)	30" (762)		1082	1133	TRGEPSR486030					
	66" (1676)	30" (762)		1092	1142	TRGEPSR486630					
	72" (1829)	30" (762)		1092	1142	TRGEPSR487230					
	78" (1981)	30" (762)		1249	1320	TRGEPSR487830					
	84" (2134)	30" (762)		1266	1336	TRGEPSR488430					

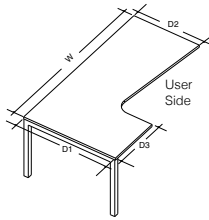

Trig Primary Work Surface – Left-Hand

Depth 1	Dimensions			List Price		Catalog Number
	Width	Depth 2	Depth 3	Thermofused Grade 1	Thermofused Grade 2	
30" (762)	54" (1372)	42" (1067)	24" (610)	\$1070	\$1120	TRGEPSL305442
30" (762)	60" (1524)			1070	1120	TRGEPSL306042
30" (762)	66" (1676)			1082	1133	TRGEPSL306642
30" (762)	72" (1829)			1082	1133	TRGEPSL307242
30" (762)	78" (1981)			1238	1309	TRGEPSL307842
30" (762)	84" (2134)			1254	1324	TRGEPSL308442
30" (762)	54" (1372)	48" (1219)	24" (610)	\$1082	\$1133	TRGEPSL305448
30" (762)	60" (1524)			1082	1133	TRGEPSL306048
30" (762)	66" (1676)			1092	1142	TRGEPSL306648
30" (762)	72" (1829)			1092	1142	TRGEPSL307248
30" (762)	78" (1981)			1249	1320	TRGEPSL307848
30" (762)	84" (2134)			1266	1336	TRGEPSL308448

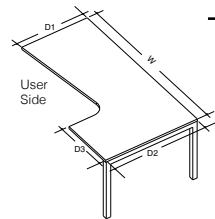

Build your complete Part Number here:

Sample Part Number:

Total Cost \$1070 =

TRGEPSR425430	.GN	N/A	.XZ2	.XZ4	.K					
\$1070	+	N/C	+	N/C	+	N/C	+	N/C	+	N/C

Secondary Work Surface

Trig Secondary Work Surfaces are 1"-thick Thermofused Laminate with a 3mm vinyl edge band.

Optional grommet available in black or silver. See grommet information in the planning section for standard grommet locations.

Right-handed Secondary Work Surfaces include a support leg for Depth 2. Support for Depth 1 must be ordered separately.

Left-handed Secondary Work Surfaces include a support leg for Depth 1. Support for Depth 2 must be ordered separately.

Secondary Work Surfaces can be used alone or paired with Primary Work Surfaces to create U-shaped workstations. Secondary Work Surfaces are available in right- and left-hand versions. Right-hand Secondary surfaces are paired with left-hand Primary Surfaces to form U-shaped workstations. Or Left-hand Secondary surfaces can be paired with right-hand

Primary Surfaces to form the mirrored affect. If Secondary Work Surfaces are paired with Primary Work Surfaces to create a U-shaped workstation, a Flush Support Plate (SICSP) must be ordered to connect the two work surfaces together.

(See Planning Guide for limitations)

Additional accessories include field-installed screens, modesties, Monitor Arms and Personal Task Lights.

Note: For 78" and 84" wide work surfaces, support is required on one end using under desk storage or a Credenza with riser.

Trig Secondary Work Surface – Right-Hand

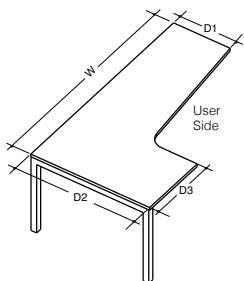

Depth 1	Dimensions			List Price Thermofused Grade		Catalog Number	Grommet	Grommet Color	Top Color	Top Edge Color	Leg Trim Color
	Width	Depth 2	Depth 3	1	2						
20" (508)	54" (1372)	42" (1067)	24" (610)	\$1070	\$1120	TRGESSR205442	No Grommet	GB Black	Thermofused Laminate (See Surface Materials Page 10)	Thermofused Laminate (See Surface Materials Page 10)	Standard Finish No Cost
	60" (1524)			1070	1120	TRGESSR206042					
	66" (1676)			1082	1133	TRGESSR206642					
	72" (1829)			1082	1133	TRGESSR207242					
	78" (1981)			1238	1309	TRGESSR207842					
84" (2134)	1254	1324	TRGESSR208442	GY Grommet	Premium Finish + \$19						
20" (508)	54" (1372)	48" (1219)	24" (610)			\$1082	\$1133	TRGESSR205448			
	60" (1524)					1082	1133	TRGESSR206048			
	66" (1676)					1092	1142	TRGESSR206648			
	72" (1829)					1092	1142	TRGESSR207248			
	78" (1981)			1249	1320	TRGESSR207848					
84" (2134)	1266	1336	TRGESSR208448								

Trig Secondary Work Surface – Left-Hand

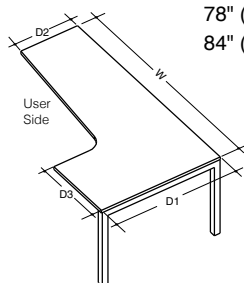

Depth 1	Dimensions			List Price Thermofused Grade		Catalog Number
	Width	Depth 2	Depth 3	1	2	
42" (1067)	54" (1372)	20" (508)	24" (610)	\$1070	\$1120	TRGESSL425420
	60" (1524)			1070	1120	TRGESSL426020
	66" (1676)			1082	1133	TRGESSL426620
	72" (1829)			1082	1133	TRGESSL427220
	78" (1981)			1238	1309	TRGESSL427820
	84" (2134)			1254	1324	TRGESSL428420
48" (1219)	54" (1372)	20" (508)	24" (610)	\$1082	\$1133	TRGESSL485420
	60" (1524)			1082	1133	TRGESSL486020
	66" (1676)			1092	1142	TRGESSL486620
	72" (1829)			1092	1142	TRGESSL487220
	78" (1981)			1249	1320	TRGESSL487820
	84" (2134)			1266	1336	TRGESSL488420

Build your complete Part Number here:

Sample Part Number:

Total Cost \$1070 =

TRGESSL425420	.GY	.GS	.XZ2	.XZ4	.K					
\$1070	+	N/C	+	N/C	+	N/C	+	N/C	+	N/C

Work Surface Support Legs

Trig Work Surface Support Legs are available in all Trendway Standard and Premium Systems Finishes.

All necessary attachment hardware is included.

Shared Work Surface Support Legs

Trig Shared Work Surface Support Legs are used when two work surfaces of equal depth are paired together back-to-back and a single support is desired. Legs are available in all Trendway Standard and Premium Systems Finishes.

All necessary attachment hardware is included.

When the Shared Work surface Support Leg is used, Flush Support Plate (SICSP) must be ordered to connect the two surfaces together in the middle.

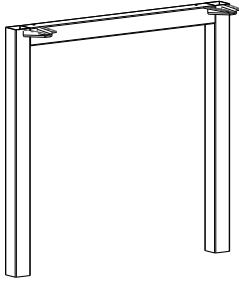

Trig Work Surface Support Legs

Depth	Dimensions Width	Height	List Price	Catalog Number	Trim Color
2" (51)	20" (508)	27 ³ / ₄ " (705)	\$346	TRGULEG20 TRGULEG24 TRGULEG30	Standard Finish No Cost Premium Finish + \$19 (See Surface Materials Page 10)
	24" (610)		346		
	30" (762)		355		

Build your complete Part Number here:

Trig Shared Work Surface Support Legs

Depth	Dimensions Width	Height	List Price	Catalog Number	Trim Color
2" (51)	40" (1016)	27 ³ / ₄ " (705)	\$434	TRGULEG40 TRGULEG48 TRGULEG60	Standard Finish No Cost Premium Finish + \$19 (See Surface Materials Page 10)
	48" (1219)		456		
	60" (1524)		469		

Build your complete Part Number here:

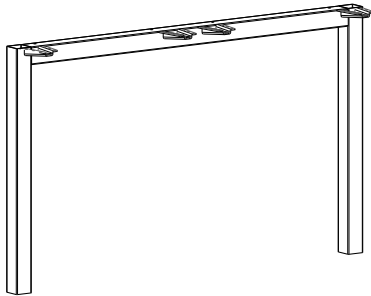

Sample Part Number:

TRGULEG20	.Y
-----------	----

Total Cost \$346 =

\$346	+	N/C
-------	---	-----

Trig Work Surface Post Leg

The Work Surface Post Leg can be used for additional mid-span support along wider Trig work surfaces. Price includes post leg, leveling glide and attachment hardware.

Note: A pair of Work Surface Post Legs cannot be used to replace Trig Work Surface Support Legs as the main support on the end of a work surface.

Trig Bench Storage Work Surface Short Support

The Bench Storage Work Surface leg is used with Trig Bench Height Storage units to support the end of a

work surface. 20" and 24" deep work surfaces use TRGBSWSL13 and 30" deep surfaces use TRGBSWSL19. Legs are available in all Trendway Standard and Premium Finishes.

All necessary attachment hardware is included.

Side to Side Shared Work Surface Support Leg

Side to Side Shared Work Surface Support Legs are used when work surfaces of equal depth are positioned next to each other and a single support is desired. Legs are available for single depth applications (equal depth

surfaces are side to side) and dual depth applications (equal depth surfaces are back to back).

In a layout with (4) equal depth work surfaces that are both front-to-back and side-to-side, a single Side to Side Shared Support Leg can be used centrally to support all (4) surfaces. Legs are available in all Trendway Standard and Premium Systems Trim Finishes.

All necessary attachment hardware is included.

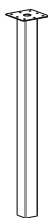

Trig Work Surface Post Leg

Leg Depth	Dimensions		List Price	Catalog Number	Trim Color
	Height				
2" (51)	27¾"	(705)	\$95	TRGSPRTLEG	Standard Finishes No Cost Premium Finishes +\$19

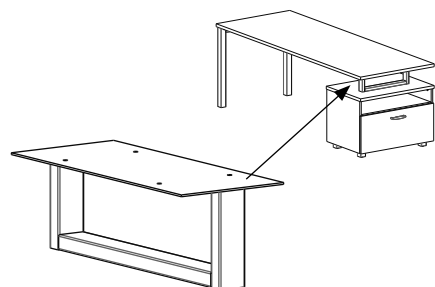

Trig Bench Storage Work Surface Short Support

Depth	Dimensions		List Price	Catalog Number	Trim Color
	Height				
13" (330)	6½"	(165)	\$214	TRGBSWSL13	Standard Finishes No Cost Premium Finishes +\$19
19" (483)			229	TRGBSWSL19	

Side to Side Shared Work Surface Support Leg

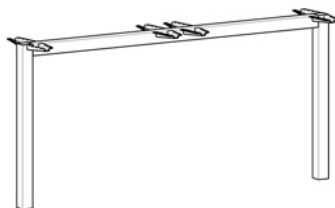

Depth	Dimensions		List Price	Catalog Number	Trim Color
	Width	Height			
2" (51)	20"	(508)	\$509	TRGULEGSS20	Standard Finish No Cost
	24"	(610)	517	TRGULEGSS24	
	30"	(762)	523	TRGULEGSS30	
	40"	(1016)	647	TRGULEGSS40	Premium Finish +\$19
	48"	(1219)	661	TRGULEGSS48	
	60"	(1524)	688	TRGULEGSS60	

(See Surface Materials Page 10)

Build your complete Part Number here:

Sample Part Number:

TRGULEGSS20	.Y
-------------	----

Total Cost \$509 =

\$509	+	N/C
-------	---	-----

Support Riser

Trig Support Riser ships with necessary hardware to mount work surface to top of Under Desk Storage or Credenza.

Available in Black only.

Work Surface Support Brackets

Trig Work Surface Support Brackets are used with Combination Storage to support work surfaces instead of Work Surface Support Legs. All necessary attachment hardware included.

Available in Black only.

Flush Support Plates

Flush Support Plates connect a work surface that extends from an adjacent work surface at the same level. Includes two mounting plates and screws. Available in Black only.

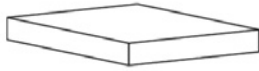

Trig Support Riser

Dimensions Height	List Price	Catalog Number
8" (203) x 13" (330) 1" (25)	\$96	TRGWSRISER
Build your complete Part Number here:		_____



Trig Work Surface Support Brackets

Dimensions	List Price	Catalog Number
Includes Two Support Brackets	\$61	TRGWSBRKTS
Build your complete Part Number here:		_____

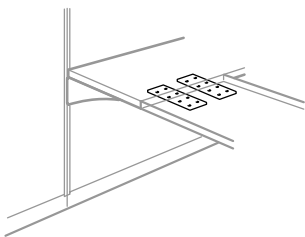

Flush Support Plates

Dimensions	List Price	Catalog Number
Includes 2 Connecting Plates	\$55	SICSP
Build your complete Part Number here:		_____
Sample Part Number:	TRGWSRISER	
Total Cost \$96 =	\$96	

Surface Mount Screens

Trig Surface Mount Screens are used when two work surfaces are positioned back-to-back with no gap between them. Screen widths can span from 24" to 84", in 6" increments. Screen widths 24" - 48" are a single screen and two posts. Screen widths 54" - 84" are 2 screens and three posts (center post is shared). All necessary mounting hardware is included.

All Screens available in either Plexiglass or 3-Form Ecoresin.

Trig Surface Mount Screens

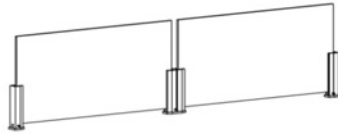

Dimensions Width Height	List Price	Catalog Number	Insert Material	Trim Color
24" (610) 13" (330)	\$790	TRGTMS2413	Plexiglass (01, 02)	Standard Finish No Cost
30" (762)	887	TRGTMS3013	No Cost	
36" (914)	903	TRGTMS3613	Frosted Plexiglass (E3A) 24" + \$46 30" - 48" + \$97 54" - 84" + \$196 3-Form (E01-E03) 24" + \$183 30" - 48" + \$393 54" - 84" + \$787	Premium Finish + \$13 (See Surface Materials Page 10)
42" (1067)	919	TRGTMS4213		
48" (1219)	933	TRGTMS4813		
54" (1372)	1410	TRGTMS5413		
60" (1524)	1488	TRGTMS6013		
66" (1676)	1505	TRGTMS6613		
72" (1829)	1505	TRGTMS7213		
78" (1961)	1520	TRGTMS7813		
84" (2134)	1520	TRGTMS8413		
24" (610) 19" (483)	\$854	TRGTMS2419		
30" (762)	966	TRGTMS3019		
36" (914)	973	TRGTMS3619		
42" (1067)	983	TRGTMS4219		
48" (1219)	998	TRGTMS4819		
54" (1372)	1488	TRGTMS5419		
60" (1524)	1615	TRGTMS6019		
66" (1676)	1646	TRGTMS6619		
72" (1829)	1646	TRGTMS7219		
78" (1961)	1663	TRGTMS7819		
84" (2134)	1663	TRGTMS8419		

Build your complete Part Number here:

-----	---	-
-------	-----	---

Sample Part Number:

TRGTMS2413	.E3A	.G
-------------------	-------------	-----------

Total Cost \$836 =

\$790	+	\$46	+	N/C
-------	---	------	---	-----

Desk Top Screens

Trig Desk Top Screens are intended to provide privacy between adjacent desks. Mostly used in benching applications. All Screens available in either plexiglass or 3-Form Ecoresin.

Back Edge Mount Screens

Trig Back Edge Mount Screens assemble to the back of a work surface with a 1" gap between it and another work surface. The gap allows for power cords to pass between them.

Note: See planning guide for proper size selection. All necessary mounting hardware is included.

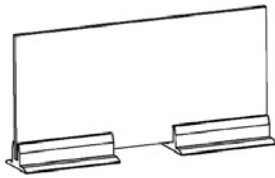

Trig Desk Top Screen

Dimensions Width Height	List Price	Catalog Number	Insert Material	Trim Color
16" (406) 8" (203)	\$247	TRGLDS168	Plexiglass (01, 02) No Cost	Standard Finish No Cost
20" (508)	261	TRGLDS208		
26" (660)	275	TRGLDS268		
38" (965)	289	TRGLDS388		
44" (1118)	302	TRGLDS448	Frosted Plexiglass (E3A) 16" - 20" + \$39 26" - 44" + \$78	Premium Finish + \$13 (See Surface Materials Page 10)
16" (406) 13" (330)	\$317	TRGLDS1613		
20" (508)	331	TRGLDS2013		
26" (660)	344	TRGLDS2613		
38" (965)	358	TRGLDS3813		
44" (1118)	371	TRGLDS4413	3-Form (E01-E03) 16" - 20" + \$118 26" - 44" + \$235	



Trig Back Edge Mount Screens

Dimensions Width Height	List Price	Catalog Number	Insert Material	Trim Color
24" (610) 13" (330)	\$606	TRGBMS2413	Plexiglass (01, 02) No Cost	
30" (762)	661	TRGBMS3013		
36" (914)	730	TRGBMS3613	Frosted Plexiglass (E3A) 24" + \$39 30" - 48" + \$104 54" - 72" + \$130	
42" (1067)	778	TRGBMS4213		
48" (1219)	820	TRGBMS4813		
54" (1372)	867	TRGBMS5413		
60" (1524)	907	TRGBMS6013		
66" (1676)	957	TRGBMS6613		
72" (1829)	1012	TRGBMS7213		
24" (610) 19" (483)	\$654	TRGBMS2419		
30" (762)	730	TRGBMS3019		
36" (914)	790	TRGBMS3619		
42" (1067)	848	TRGBMS4219		
48" (1219)	889	TRGBMS4819		
54" (1372)	951	TRGBMS5419		
60" (1524)	1019	TRGBMS6019		
66" (1676)	1093	TRGBMS6619		
72" (1829)	1158	TRGBMS7219		

Build your complete Part Number here:

Sample Part Number:

Total Cost \$286 =

-----	---	-
TRGLDS168	.E3A	.G
\$247	+ \$39	+ N/C

Modesty

The Trig Modesty mounts 2" from the back edge of the work surface.

Note: See planning guide to proper size selection. All necessary mounting hardware is included.

Note: Modesty Only

If electrical components are to be used with a Modesty-Only configuration on a Rectangle, Wedge or Blade work surface, the optional grommet should be selected for cord pass-through.

Screen/Modesty Combination

The Trig Screen/Modesty Combination mounts to the underside back edge of a work surface. There is a 1" gap between the Screen/Modesty and the work surface, allowing power cords to pass between them.

See planning guide for proper size selection. All necessary mounting hardware is included. All Modesty and Screen Modesty Combinations available in either plexiglass or 3-Form Ecoresin.



Trig Modesty

Dimensions Width Height	List Price	Catalog Number	Insert Material	Trim Color	
24" (610)	14" (356)	\$536	TRGMOD24	Plexiglass (01, 02) No Cost	Standard Finish No Cost
30" (762)		578	TRGMOD30		
36" (914)		620	TRGMOD36	Frosted Plexiglass (E3A) 24" + \$39 30" - 60" + \$78 66" - 72" + \$104 3-Form (E01-E03) 24" + \$158 30" - 60" + \$315 66" - 72" + \$421	Premium Finish + \$13 (See Surface Materials Page 10)
42" (1067)		676	TRGMOD42		
48" (1219)		744	TRGMOD48		
54" (1372)		799	TRGMOD54		
60" (1524)		867	TRGMOD60		
66" (1676)		924	TRGMOD66		
72" (1829)		977	TRGMOD72		
Build your complete Part Number here:		-----	--		

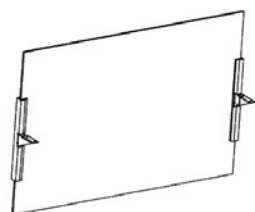

Trig Screen/Modesty Combination

Dimensions Width Height	List Price	Catalog Number	Insert Material	Trim Color	
24" (610)	28" (711)	\$716	TRGBMSM2428	Plexiglass (01, 02) No Cost	Standard Finish No Cost
30" (762)		812	TRGBMSM3028		
36" (914)		917	TRGBMSM3628	Frosted Plexiglass (E3A) 24" + \$78 30" - 60" + \$196 66" - 72" + \$261 3-Form (E01-E03) 24" + \$315 30" - 60" + \$787 66" - 72" + \$917	Premium Finish + \$13 (See Surface Materials Page 10)
42" (1067)		977	TRGBMSM4228		
48" (1219)		1054	TRGBMSM4828		
54" (1372)		1081	TRGBMSM5428		
60" (1524)		1141	TRGBMSM6028		
66" (1676)		1233	TRGBMSM6628		
72" (1829)		1321	TRGBMSM7228		
Build your complete Part Number here:		-----	--		

Sample Part Number:

TRGMOD24	.E01	.G
----------	------	----

Total Cost \$694 =

\$536	+	\$158	+	N/C
-------	---	-------	---	-----

Acrylic Modesty

The Acrylic Modesty mounts to the underside of any work surface or table to provide privacy. Included with the modesty is a 1/4" thick Frosted Acrylic and brackets. The brackets are a raw aluminum finish.

Note: The actual width of the acrylic modesty is 2" shorter than nominal.

Note: There is no gap between the acrylic and the underside of the desk for cable pass through.

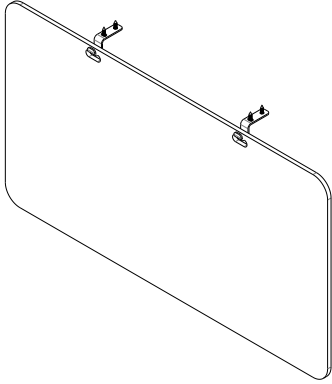

Acrylic Modesty

Dimensions		List Price	Catalog Number
Width	Height		
24" (610)	12" (305)	\$212	MODACRC2412
30" (762)		232	MODACRC3012
36" (914)		251	MODACRC3612
42" (1067)		273	MODACRC4212
48" (1219)		294	MODACRC4812
54" (1372)		333	MODACRC5412
60" (1524)		360	MODACRC6012
66" (1676)		388	MODACRC6612
72" (1829)		415	MODACRC7212

Single Acrylic Screen - Post Style Bracket- Screw Mount

The Post Style Bracket can be mounted with screws to any laminate work surface, desk or table top to provide a division. Included with the Screen are two posts, one acrylic screen, and the necessary mounting hardware.

Note: The No Gap option will have a 3/4" gap to allow for cord pass through.

Note: The actual width of the acrylic screen is 3 3/8" shorter than nominal.

Access Slot Width Opening	
Width	Access Slot Opening
24"	10.13"
30"	16.13"
36"	22.13"
42"	20.13"
48"	26.13"
54"	32.13"
60"	30.13"
66"	36.13"
72"	42.13"

Single Acrylic Screen - Post Style Bracket- Screw Mount

Dimensions		List Price		Catalog Number	Work Surface Gapping	Insert Material	Trim Color
Width	Height	Clear Plexi 01	Frosted Plexi E3A				
24" (610)	24" (610)	\$ 462	\$ 501	SCNSMPS2424	NP No Gap 4A 4" Access Slot along back	01 Clear Plexi E3A Frosted Plexi	Standard Finish No Cost Premium Finishes +\$13
30" (762)							
36" (914)							
42" (1067)							
48" (1219)							
54" (1372)							
60" (1524)							
66" (1676)							
72" (1829)							
24" (610)	30" (762)	462	543	SCNSMPS2430			
30" (762)							
36" (914)							
42" (1067)							
48" (1219)							
54" (1372)							
60" (1524)							
66" (1676)							
72" (1829)							
24" (610)	36" (914)	548	627	SCNSMPS2436			
30" (762)							
36" (914)							
42" (1067)							
48" (1219)							
54" (1372)							
60" (1524)							
66" (1676)							
72" (1829)							

Build your complete Part Number here:

-----	---	---	--
-------	-----	-----	----

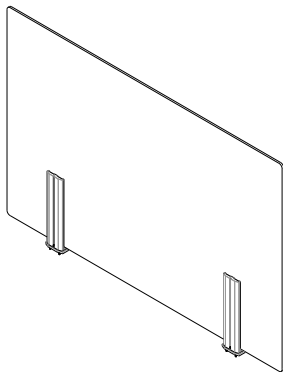

Sample Part Number:

SCNSMPS2424	.4A	.01	.K
-------------	-----	-----	----

Total Cost \$420 =

\$1339	+	N/A	+	N/A	+	N/A
--------	---	-----	---	-----	---	-----

Single Acrylic Screen - Freestanding Plate

The Freestanding Acrylic Screen can be placed on any work surface or table to provide a division. Included with the screen is either 2 or 4 Gray Brackets depending on the width of the screen. The brackets come with two types of foam pads for the underside of the bracket plates based on installation needs. One pad helps to prevent the screen from skidding on the worksurface, and the other pad uses double-sided tape for more of a secure attachment.

Note: The actual width of the acrylic screen is 3 3/8" shorter than nominal.

Note: Screens 24-54" in width will have 2 brackets and Screens 60-72" in width will have 4 brackets.

Access Slot Width Opening	
Width	Access Slot Opening
24"	9.5"
30"	15.5"
36"	21.5"
42"	23.5"
48"	29.5"
54"	35.5"
60"	14.187"
66"	16.187"
72"	18.187"

Single Acrylic Screen - Freestanding Plate

Dimensions		List Price		Catalog Number	Work Surface Gapping	Insert Material
Width	Height	Clear Plexi 01	Frosted Plexi E3A			
24" (610)	24" (610)	\$ 363	\$ 425	SCNAFS2424	NP No Gap 4A 4" Access Slot along back	01 Clear Plexi E3A Frosted Plexi
30" (762)		383	461	SCNAFS3024		
36" (914)		404	497	SCNAFS3624		
42" (1067)		425	533	SCNAFS4224		
48" (1219)		447	571	SCNAFS4824		
54" (1372)		478	617	SCNAFS5424		
60" (1524)		555	711	SCNAFS6024		
66" (1676)		576	747	SCNAFS6624		
72" (1829)	598	785	SCNAFS7224			
24" (610)	30" (762)	383	461	SCNAFS2430		
30" (762)		410	506	SCNAFS3030		
36" (914)		436	552	SCNAFS3630		
42" (1067)		463	599	SCNAFS4230		
48" (1219)		489	645	SCNAFS4830		
54" (1372)		525	699	SCNAFS5430		
60" (1524)		608	803	SCNAFS6030		
66" (1676)		634	848	SCNAFS6630		
72" (1829)	661	895	SCNAFS7230			
Build your complete Part Number here:				-----	---	---

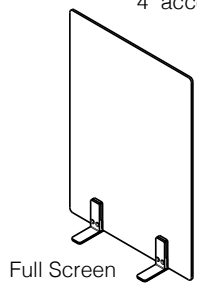
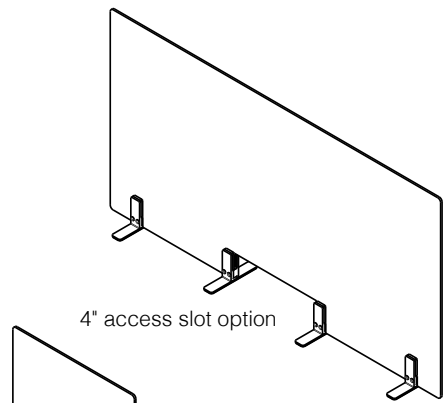

Sample Part Number:

SCNAFS2424	.4A	.01
------------	-----	-----

Total Cost \$330 =

\$1339	+	N/A	+	N/A
--------	---	-----	---	-----

Single Acrylic Screen - Edge Mount Bracket

The Edge Mount Bracket uses clamps to attach to the back edge of a work surface. It is compatible with work surfaces up to 1 1/3" thick. The screen sits slightly offset from the back edge, creating a 3/4" gap to facilitate power/data cable management and other accessories. The final installed height of the

screen is measured from the desktop to the top of the screen. The screen width is 3/8" shorter than nominal. All necessary mounting hardware is included.

Note: Screens 24"-54" wide will ship with 2 brackets. Screens 60" and wider will ship with 3 brackets.

Single Acrylic Screen - Edge Mount Bracket

Dimensions Width	Height	List Price		Catalog Number	Insert Material	Bracket Color
		Clear Plexi 01	Frosted Plexi E3A			
24" (610)	24" (610)	\$ 338	\$ 400	SCNBECMS2424	No Cost 01 Clear Plexi	G Gray
30" (762)		359	438	SCNBECMS3024		
36" (914)		381	475	SCNBECMS3624		
42" (1067)		402	513	SCNBECMS4224		
48" (1219)		424	550	SCNBECMS4824		
54" (1372)		456	599	SCNBECMS5424		
60" (1524)		500	658	SCNBECMS6024		
66" (1676)		521	695	SCNBECMS6624		
72" (1829)	543	733	SCNBECMS7224	E3A Frosted Plexi	DW Designer White	
24" (610)	30" (762)	\$ 359	\$ 438			SCNBECMS2430
30" (762)		387	486			SCNBECMS3030
36" (914)		413	531			SCNBECMS3630
42" (1067)		441	579			SCNBECMS4230
48" (1219)		467	626			SCNBECMS4830
54" (1372)		504	682			SCNBECMS5430
60" (1524)		554	752			SCNBECMS6030
66" (1676)		580	798			SCNBECMS6630
72" (1829)		607	846			SCNBECMS7230

Build your complete Part Number here:

-----	---	---
-------	-----	-----

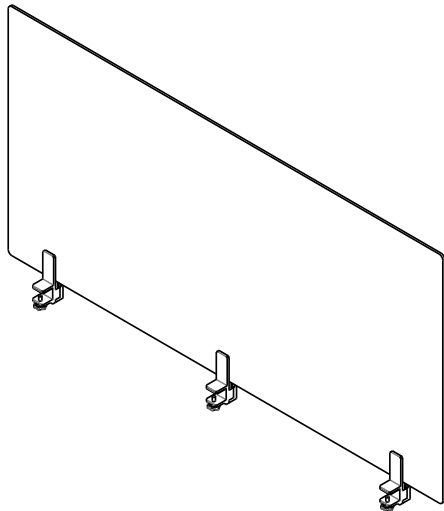

Sample Part Number:

SCNBECMS2424	.01	.G
--------------	-----	----

Total Cost \$ 338 =

\$338	+	N/A	+	N/A
-------	---	-----	---	-----

Single Acrylic Screen - Top Mount Bracket

The Top Mount Bracket uses clamps to attach to the top of the work surface. It is compatible with work surfaces up to 1 1/3" thick. The screen sits on the work surface creating a 1 3/4" gap between the work surface and the bottom of the screen. The final installed height of the screen is measured from the desktop to the top of the screen. The screen width is 3/8" shorter than nominal. All necessary mounting hardware is included.

Note: Screens 24"-54" wide will ship with 2 brackets. Screens 60" and wider will ship with 3 brackets.

Corner Connector Kit

The Corner Connector Kit attaches Edge Mount Screens to Top Mount Screens at the intersecting corners. This creates 'L' and 'U' shape configurations connected as one unit. The SCNCCK Kit provides 2 brackets to create one corner connection for an 'L' Shape. The SCNCCK2 Kit

provides 4 brackets to accommodate 2 corner connections for a 'U' Shape.

Note: these are the same corner brackets used with the Post Style and Low Profile Bracket Screens, and can be utilized as service parts for these screens if needed.

Single Acrylic Screen - Top Mount Bracket

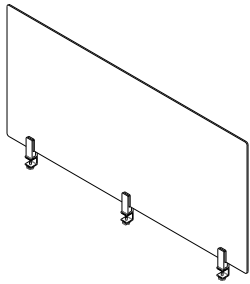

Dimensions		List Price		Catalog Number	Insert Material	Bracket Color	
Width	Height	Clear Plexi 01	Frosted Plexi E3A				
24" (610)	24" (610)	\$ 338	\$ 400	SCNDTCMS2424	No Cost 01 Clear Plexi	G Gray	
30" (762)		359	438	SCNDTCMS3024			
36" (914)		381	475	SCNDTCMS3624			
42" (1067)		402	513	SCNDTCMS4224			
48" (1219)		424	550	SCNDTCMS4824		E3A Frosted Plexi	K Charcoal
54" (1372)		456	599	SCNDTCMS5424			
60" (1524)		500	658	SCNDTCMS6024			
66" (1676)		521	695	SCNDTCMS6624			
72" (1829)	543	733	SCNDTCMS7224	DW Designer White			
24" (610)	30" (762)	\$ 359	\$ 438		SCNDTCMS2430		
30" (762)		387	486		SCNDTCMS3030		
36" (914)		413	531		SCNDTCMS3630		
42" (1067)		441	579		SCNDTCMS4230		
48" (1219)		467	626		SCNDTCMS4830		
54" (1372)		504	682		SCNDTCMS5430		
60" (1524)		554	752		SCNDTCMS6030		
66" (1676)		580	798	SCNDTCMS6630			
72" (1829)	607	846	SCNDTCMS7230				
Build your complete Part Number here:				-----	---	---	

Corner Connector Kit

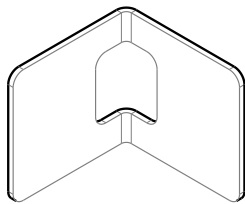

	List Price	Catalog Number	Trim Color
2 Brackets to Connect 1 Corner	\$ 55	SCNCCK	Standard Finish No Cost
4 Brackets to Connect 2 Corners	\$ 88	SCNCCK2	Premium Finishes \$13

Note: For the Clamp Mount Screens specify Gray, Charcoal or Designer White to match the bracket color.

Sample Part Number:

SCNDTCMS2424	.01	.G
--------------	-----	----

Total Cost \$338 =

\$338	+	N/A	+	N/A
-------	---	-----	---	-----

U-Shape Acrylic Screen - Post Style Bracket

The U-Shape Post Style Bracket can be mounted with screws or adhesive to any laminate work surface, desk or table top to provide a division. Included with the screen are six posts, three acrylic screens, and the necessary mounting hardware.

Note: The No Gap option will have a 3/4" gap to allow for cord pass through.

Note: The minimum overall width of a desk needed to house a screen is 2.25" less than nominal. The minimum overall depth needed to house the screen is 2.5" less than the nominal depth.

Access Slot Width Opening	
Width	Access Slot Opening
36"	22.13"
42"	20.13"
48"	26.13"
54"	32.13"
60"	30.13"
66"	36.13"
72"	42.13"

U-Shape Acrylic Screen - Post Style Bracket

Width	Dimensions		List Price		Catalog Number	Work Surface Gapping	Insert Material	Trim Color
	Depth	Height	Clear Plexi 01	Frosted Plexi E3A				
36" (914)	24" (610)	24" (610)	\$ 1408	\$ 1567	SCNSMPU362424	NP No Gap	01 Clear Plexi	Standard Finish No Cost
42" (1067)			1413	1572	SCNSMPU422424			
48" (1219)			1419	1578	SCNSMPU482424			
54" (1372)			1435	1846	SCNSMPU542424			
60" (1524)			1446	1853	SCNSMPU602424			
66" (1676)			1611	1858	SCNSMPU662424			
72" (1829)			1622	1864	SCNSMPU722424			
36" (914)			30" (762)	24" (610)	1408			
42" (1067)	1413	1655			SCNSMPU423024			
48" (1219)	1419	1661			SCNSMPU483024			
54" (1372)	1435	1930			SCNSMPU543024			
60" (1524)	1446	1935			SCNSMPU603024			
66" (1676)	1611	1941			SCNSMPU663024			
72" (1829)	1622	1946			SCNSMPU723024			
36" (914)	24" (610)	30" (762)			1408	1738	SCNSMPU362430	4A 4" Access Slot along back
42" (1067)			1413	1743	SCNSMPU422430			
48" (1219)			1419	1749	SCNSMPU482430			
54" (1372)			1493	2435	SCNSMPU542430			
60" (1524)			1507	2442	SCNSMPU602430			
66" (1676)			1611	2447	SCNSMPU662430			
72" (1829)			1622	2452	SCNSMPU722430			
36" (914)			30" (762)	30" (762)	1465	2073	SCNSMPU363030	
42" (1067)	1474	2079			SCNSMPU423030			
48" (1219)	1485	2084			SCNSMPU483030			
54" (1372)	1553	2777			SCNSMPU543030			
60" (1524)	1567	2782			SCNSMPU603030			
66" (1676)	1669	2787			SCNSMPU663030			
72" (1829)	1683	2794			SCNSMPU723030			
36" (914)	24" (610)	36" (914)			1757	2070	SCNSMPU362436	4A 4" Access Slot along back
42" (1067)			1765	2078	SCNSMPU422436			
48" (1219)			1771	2084	SCNSMPU482436			
54" (1372)			1784	2606	SCNSMPU542436			
60" (1524)			1798	2612	SCNSMPU602436			
66" (1676)			2131	2617	SCNSMPU662436			
72" (1829)			2145	2623	SCNSMPU722436			
36" (914)			30" (762)	36" (914)	1757	2239	SCNSMPU363036	
42" (1067)	1765	2243			SCNSMPU423036			
48" (1219)	1771	2249			SCNSMPU483036			
54" (1372)	1784	2777			SCNSMPU543036			
60" (1524)	1798	2782			SCNSMPU603036			
66" (1676)	2131	2787			SCNSMPU663036			
72" (1829)	2145	2794			SCNSMPU723036			

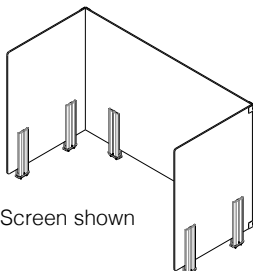

Full Screen shown

Build your complete Part Number here:

Sample Part Number:

Total Cost \$1280 =

-----	---	---	--
SCNSMPU362424	.NP	.01	.K
\$1339	+	N/A	+
		N/A	+
			N/A

U-Shape Acrylic Screen - Low Profile Bracket

The U-Shape Low Profile Bracket can be mounted with adhesive to any laminate work surface, desk or table top to provide a division. Included with the screen are six brackets, three acrylic screens, and the necessary mounting hardware.

Note: The minimum overall width of a desk needed to house a screen is 2.25" less than nominal. The minimum overall depth needed to house the screen is 2.125" less than the nominal depth.

Access Slot Width Opening	
Width	Access Slot Opening
36"	18.88"
42"	16.88"
48"	22.88"
54"	28.88"
60"	26.88"
66"	32.88"
72"	38.88"

Note: The No Gap option will have a .6" gap to allow for cord pass through.

U-Shape Acrylic Screen - Low Profile Bracket

Width	Dimensions		List Price		Catalog Number	Work Surface Gapping	Insert Material	Trim Color
	Depth	Height	Clear Plexi 01	Frosted Plexi E3A				
36" (914)	24" (610)	24" (610)	\$ 852	\$ 1011	SCNTDMU362424	NP No Gap 4A 4" Access Slot along back screen	01 Clear Plexi E3A Frosted Plexi	Standard Finish No Cost Premium Finishes +\$
42" (1067)			858	1017	SCNTDMU422424			
48" (1219)			863	1022	SCNTDMU482424			
54" (1372)			881	1292	SCNTDMU542424			
60" (1524)			891	1298	SCNTDMU602424			
66" (1676)			1056	1303	SCNTDMU662424			
72" (1829)			1067	1309	SCNTDMU722424			
36" (914)	30" (762)	24" (610)	852	1094	SCNTDMU363024			
42" (1067)			858	1100	SCNTDMU423024			
48" (1219)			863	1105	SCNTDMU483024			
54" (1372)			881	1376	SCNTDMU543024			
60" (1524)			891	1380	SCNTDMU603024			
66" (1676)			1056	1386	SCNTDMU663024			
72" (1829)			1067	1391	SCNTDMU723024			
36" (914)	24" (610)	30" (762)	852	1182	SCNTDMU362430			
42" (1067)			858	1188	SCNTDMU422430			
48" (1219)			863	1193	SCNTDMU482430			
54" (1372)			939	1880	SCNTDMU542430			
60" (1524)			951	1886	SCNTDMU602430			
66" (1676)			1056	1892	SCNTDMU662430			
72" (1829)			1067	1897	SCNTDMU722430			
36" (914)	30" (762)	30" (762)	910	1517	SCNTDMU363030			
42" (1067)			918	1523	SCNTDMU423030			
48" (1219)			924	1529	SCNTDMU483030			
54" (1372)			997	2221	SCNTDMU543030			
60" (1524)			1006	2227	SCNTDMU603030			
66" (1676)			1113	2232	SCNTDMU663030			
72" (1829)			1127	2238	SCNTDMU723030			

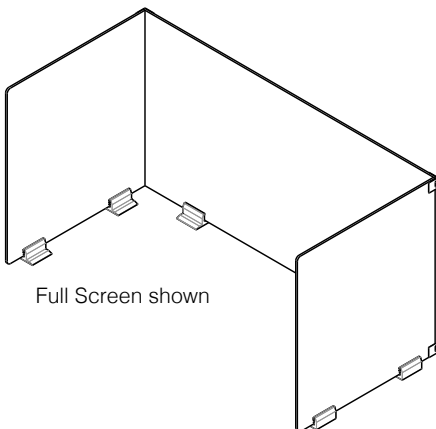

Build your complete Part Number here:

_____	---	---	--
-------	-----	-----	----

Sample Part Number:

SCNTDMU362424	.NP	.01	.K
---------------	-----	-----	----

Total Cost \$775 =

\$1339	+	N/A	+	N/A	+	N/A
--------	---	-----	---	-----	---	-----

Trig Top Mounted Fabric Screen

The Trig Top Mounted Fabric Screens are mounted on top of a Trig Desk. The 18, 22 and 28 inch screens are designed to work as side screens. The larger widths are designed to mount to the front edge of a surface, or across the seam of two surfaces positioned back to back. The screen is fully tackable, fabric covered, and comes with all the hardware to attach it. The

hardware has a small reveal at the very bottom of the screen and what the trim color is related to.

Trig Fabric Screen / Modesty Combination

The Trig Fabric Screen Modesty Combination mounts to the underside back edge of the desk top. The screen is fully tackable, fabric covered, and comes with all the hardware to attach

it. It provides 13" of privacy above the surface and 14" below the surface. Match the screen width to the Trig desk width.

Note: The Fabric Screen/ Modesty Combination cannot be used in conjunction with the Trig Power Raceway.

Trig Top Mount Fabric Screen

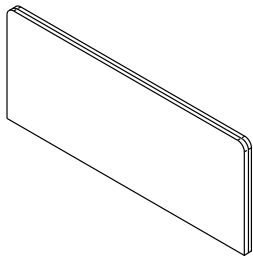

Dimensions		List Price Fabric Grade						Catalog Number	Fabric Color	Trim Color
Width	Height	0/1	2	3	4	5	6			
18" (457)	13" (330)	\$ 647	\$ 702	\$ 735	\$ 785	\$ 842	\$ 902	TRGFTMS1813	(See Surface Materials Page 7)	Standard Smooth Finishes Only
22" (559)		658	713	746	796	853	913	TRGFTMS2213		
28" (711)		698	753	786	836	893	953	TRGFTMS2813		
35 7/8" (911)		795	850	883	933	990	1050	TRGFTMS3613		
41 7/8" (1064)		842	897	930	980	1037	1097	TRGFTMS4213		
47 7/8" (1216)		888	943	976	1026	1083	1143	TRGFTMS4813		
53 7/8" (1368)		939	994	1027	1077	1134	1194	TRGFTMS5413		
59 7/8" (1521)		986	1041	1074	1124	1181	1241	TRGFTMS6013		
65 7/8" (1673)		1037	1092	1125	1175	1232	1292	TRGFTMS6613		
71 7/8" (1826)		1084	1139	1172	1222	1279	1339	TRGFTMS7213		
18" (457)	19" (483)	\$ 656	\$ 711	\$ 744	\$ 807	\$ 880	\$ 950	TRGFTMS1819		
22" (559)		668	723	756	819	892	962	TRGFTMS2219		
28" (711)		711	766	799	862	935	1005	TRGFTMS2819		
35 7/8" (911)		811	866	899	962	1035	1105	TRGFTMS3619		
41 7/8" (1064)		860	915	948	1011	1084	1154	TRGFTMS4219		
47 7/8" (1216)		909	964	997	1060	1133	1203	TRGFTMS4819		
53 7/8" (1368)		963	1018	1051	1114	1187	1257	TRGFTMS5419		
59 7/8" (1521)		1013	1068	1101	1164	1237	1307	TRGFTMS6019		
65 7/8" (1673)		1067	1122	1155	1218	1291	1361	TRGFTMS6619		
71 7/8" (1826)		1116	1171	1204	1267	1340	1410	TRGFTMS7219		

Trig Fabric Screen/Modesty Combination

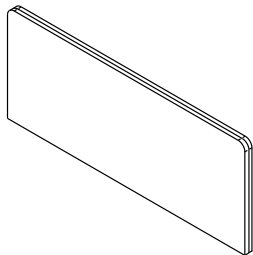

Dimensions		List Price Fabric Grade						Catalog Number	Fabric Color	Trim Color
Width	Height	0/1	2	3	4	5	6			
23 3/4" (603)	28" (711)	\$ 733	\$ 790	\$ 838	\$ 939	\$ 1054	\$ 1164	TRGFSMC2428		
29 3/4" (756)		778	835	883	984	1099	1209	TRGFSMC3028		
35 3/4" (908)		831	888	936	1037	1152	1262	TRGFSMC3628		
41 3/4" (1060)		885	944	990	1107	1232	1362	TRGFSMC4228		
47 3/4" (1213)		938	997	1048	1177	1323	1466	TRGFSMC4828		
53 3/4" (1365)		1075	1134	1185	1314	1460	1603	TRGFSMC5428		
59 3/4" (1518)		1128	1187	1238	1394	1568	1746	TRGFSMC6028		
65 3/4" (1670)		1186	1245	1296	1452	1626	1804	TRGFSMC6628		
71 3/4" (1822)		1239	1298	1349	1505	1679	1857	TRGFSMC7228		
Build your complete Part Number here:								----		

Sample Part Number:

TRGFTMS1813	.KK6	.G
-------------	------	----

Total Cost \$647 =

\$647	+	N/C	+	N/C
-------	---	-----	---	-----

Credenzas

Trig Credenza come with a 1" Thermofused laminate top and 2" support legs with leveling glides. Credenzas are 20" deep and 26.75" high. Units are intended for freestanding applications. Units ship fully assembled except for 2" support legs.

Note: Trim color includes support legs and Framed Door option (FD) when selected.

Credenzas with Doors

Features include hinged doors with optional locking. (Locking not available on aluminum door option) Credenzas 60", 72" and 75" wide have (1) adjustable shelf in each double door. The 45" wide Credenza has one adjustable shelf in the double door and one in the single door. Shelves adjust vertically in 2 1/2" increments.

Trig Credenzas with Doors

Dimensions Depth Width Height	List Price Thermofused Grade		Catalog Number	Door Style	Framed Door Insert	Pull Style	Unit/ Shelf Color	Top Color	Top Edge Color	Door Color	Trim Color	Lock Type	Lock Option
	1	2											
Double Door and Single Door RH 20" (508) 30" (762) 26 ³ / ₄ " (680)	\$1721	\$1791	TRGCDDSDR45	LD No Cost Lami- nate Door	Plexi- glass No Cost	No Cost Applied	Thermo- fused Laminate	Thermo- fused Laminate	Thermo- fused Laminate	Thermo- fused Laminate	Stand- ard Finish No Cost	NL No Cost No Lock	R No Cost Trig Ran- dom
Double Door and Single Door LH 20" (508) 36" (914) 26 ³ / ₄ " (680)	1721	1791	TRGCDDSDL45	FD Framed Door 3 Doors + \$1180 4 Doors + \$1574	Frosted Plexi- glass (E3A) 3 Doors + \$196	L Classic E Stream- line AZ Designer MM Mod2	(See Surface Materials Page 10)	(See Surface Materials Page 10)	(See Surface Materials Page 10)	Door Edge will match door color Specify only if LD selected	Pre- mium Finish + \$13 (See Surface Materials Page 10)	TRG Trig Lock + \$47 Trig Lock	T \$-30 Trig Key Alike Note: Be sure to order core/ key sets (TLCK) sepa- rately (2 per unit)
2 Double Door 20" (508) 60" (1524) 26 ³ / ₄ " (680)	\$2169	\$2263	TRGC2DD60		3-Form (E01- E03) 3 Doors + \$393 4 Doors + \$524	MD Modern Not avail- able with framed door (FD) option							
2 Double Door w/ 2 Center Shelves 20" (508) 72" (1829) 26 ³ / ₄ " (680) 20" (508) 75" (1905) 26 ³ / ₄ " (680)	\$2427 \$2492	\$2553 \$2618	TRGC2DDCS72 TRGC2DDCS75										
Build your complete Part Number here: _____													

Sample Part Number:

TRGC2DDCS75	.FD	.MM	.XZ2	.XZ4	.XZ4	N/A	.K	.TRG	.R
-------------	-----	-----	------	------	------	-----	----	------	----

Total Cost \$4083 =

\$2492	+	\$1574	+	N/C	+	N/C	+	N/C	+	N/C	+	N/C	+	\$47	+	\$-30
--------	---	--------	---	-----	---	-----	---	-----	---	-----	---	-----	---	------	---	-------

Trig Credenzas with Doors and Shelves

Depth	Dimensions		List Price Thermofused Grade		Catalog Number	Door Style	Framed Door Insert	Pull Style	Unit/Shelf Color	Top Color	Top Edge Color	Door Color	Trim Color	Lock Type	Lock Option
	Width	Height	1	2											
20" (508)	60" (1524)	26 ³ / ₄ " (680)	\$1970	\$2064	TRGCDDOSR60	LD No Cost Laminate Door	Plexi-glass No Cost	No Cost Applied	Thermo-fused Laminate	Thermo-fused Laminate	Thermo-fused Laminate	Thermo-fused Laminate	Standard Finish No Cost	NL No Cost No Lock	R No Cost Trig Random
20" (508)	60" (1524)	26 ³ / ₄ " (680)	1970	2064	TRGCDDOSL60	FD Framed Door + \$787	Frosted Plexi-glass (E3A) + \$130	L Classic E Stream-line AZ Designer MM Mod2 MD Modern Not available with framed door (FD) option	(See Surface Materials Page 10)	(See Surface Materials Page 10)	(See Surface Materials Page 10)	Door Edge will match door color Specify only if LD selected	Premium Finish + \$13 (See Surface Materials Page 10)	TRG (One Lock) + \$31 Trig Lock	T \$-15 Trig Key Alike Note: Be sure to order core/key sets (TLCK) separately (2 per unit)
Build your complete Part Number here:			---	---	---	---	---	---	---	---	---	---	---	---	---

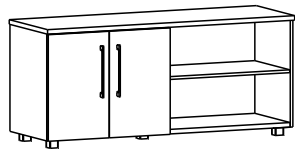

Right-Hand Shown

Sample Part Number:

TRGCDDOSR60	.FD	.E3A	.MM	.XZ2	.XZ4	.XZ4	N/A	.K	.TRG	.T
-------------	-----	------	-----	------	------	------	-----	----	------	----

Total Cost \$3034 =



\$1970	+	\$787	+	\$261	+	N/C	+	N/C	+	N/C	+	N/C	+	N/C	+	\$31	+	\$-15
--------	---	-------	---	-------	---	-----	---	-----	---	-----	---	-----	---	-----	---	------	---	-------

Credenzas with Laterals

Lateral units include full extension ball bearing slides, and interlock mechanism that allows only one drawer to open at a time, side-to-side filing bars, front to back filing bars, and adjustable leveling glides. Drawers accommodate side-to-side letter, A4, legal and EDP filing. Shelves adjust vertically in 2 1/2" increments.

For 45" wide Lateral Single Door units, the single door includes hinged door with optional locking and (1) adjustable shelf. Shelf adjusts vertically in 2 1/2" increments.

Trig Credenzas with Laterals

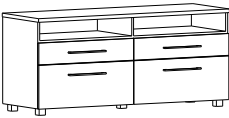
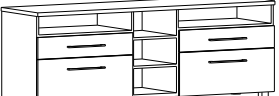
Depth	Dimensions		Locks	List Price Thermofused Grade		Catalog Number	Pull Style	Unit/ Shelf Color	Top Color	Top Edge Color	Drawer Color	Trim Color	Lock Type	Lock Option
	Width	Height		1	2									
12 Lat with Open Shelves														
20" (508)	30" (762)	26 3/4" (680)	1 Lock	\$1446	\$1497	TRGCLATOS30	No Cost Applied	Thermo-fused Laminate	Thermo-fused Laminate	Thermo-fused Laminate	Thermo-fused Laminate	Standard Finish No Cost	NL No Cost No Lock	R No Cost Trig Random
														
(612) Lateral and 2 Open Shelves RH														
20" (508)	45" (1143)	26 3/4" (680)	1 Lock	\$1804	\$1874	TRGCLATOSR45	L Classic E Stream-line AZ De-signer	(See Surface Materials Page 10)	(See Surface Materials Page 10)	(See Surface Materials Page 10)	Drawer Edge will match Drawer Color	Premium Finish + \$13 (See Surface Materials Page 10)	TRG (One Lock) + \$31 Trig Lock (Two Locks) + \$47 Trig Lock	T (One Lock) \$-15 (Two Locks) \$30 Trig Alike Note: Be sure to order core/ key sets (TLCK) separately.
20" (508)	48" (1219)	26 3/4" (680)	1 Lock	1849	1919	TRGCLATOSR48								
20" (508)	60" (1524)	26 3/4" (680)	2 Locks	2032	2127	TRGCLATOSR60								
(612) Lateral and 2 Open Shelves LH														
20" (508)	45" (1143)	26 3/4" (680)	1 Lock	\$1804	\$1874	TRGCLATOSL45	MM Mod2 MD Modern	(See Surface Materials Page 10)	(See Surface Materials Page 10)	(See Surface Materials Page 10)	Drawer Edge will match Drawer Color	Premium Finish + \$13 (See Surface Materials Page 10)	TRG (One Lock) + \$31 Trig Lock (Two Locks) + \$47 Trig Lock	T (One Lock) \$-15 (Two Locks) \$30 Trig Alike Note: Be sure to order core/ key sets (TLCK) separately.
20" (508)	48" (1219)	26 3/4" (680)	1 Lock	1849	1919	TRGCLATOSL48								
20" (508)	60" (1524)	26 3/4" (680)	2 Locks	2032	2127	TRGCLATOSL60								
 <p>Right-Hand Shown</p>														
2 (612) Lateral														
20" (508)	60" (1524)	26 3/4" (680)	2 Locks	\$2376	\$2470	TRGC2LAT60								
														
2 (612) Lateral w/ 2 Center Shelves														
20" (508)	72" (1829)	26 3/4" (508)	2 Locks	\$2674	\$2799	TRGC2LATCS72								
20" (508)	75" (1905)	26 3/4" (508)	2 Locks	\$2748	\$2874	TRGC2LATCS75								
														
Build your complete Part Number here:						_____	__	---	---	---	---	-	---	-

Sample Part Number:

TRGCLATOSR45	.MD	.ZX2	.XZ2	.XZ2	.XZ2	.K	.TRG	.R
---------------------	------------	-------------	-------------	-------------	-------------	-----------	-------------	-----------

Total Cost \$1835 =

\$1804	+	N/C	+	N/C	+	N/C	+	N/C	+	N/C	+	\$31	+	N/C
--------	---	-----	---	-----	---	-----	---	-----	---	-----	---	------	---	-----

Credenzas Continued

Note: Trim color includes support legs and Framed Door option (FD) when selected.

Single lock can be specified for laterals.

Trig Credenzas with Doors and Laterals

Depth	Dimensions		List Price Thermofused Grade		Catalog Number	Door Style	Framed Door Insert	Pull Style	Unit/ Shelf Color	Top Color	Top Edge Color	Drawer/ Door Color	Trim Color	Lock Type	Lock Option
	Width	Height	1	2											
(612) Lateral and Single Door RH 20" (508)	45" (1143)	26 ³ / ₄ " (680)	\$1887	\$1958	TRGCLATSDR45	LD No Cost	Plexi-glass (01, 02) No Cost	No Cost Applied	Thermo-fused Laminate	Thermo-fused Laminate	Thermo-fused Laminate	Thermo-fused Laminate	Standard Finish No Cost	NL No Cost No Lock	R No Cost Trig Random
(612) Lateral and Single Door LH 20" (508)	45" (1143)	26 ³ / ₄ " (680)	1887	1958	TRGCLATSDL45	Laminate Door FD + \$393 Framed Door	Frosted Plexi-glass (E3A) +\$66 3-Form (E01-E03) +\$130	L Classic E Stream-line AZ Designer MD Modern MM Mod2	(See Surface Materials Page 10)	(See Surface Materials Page 10)	(See Surface Materials Page 10)	(See Surface Materials Page 10) Specify for Lateral/ Laminate Door only	Premium Finish + \$13 (See Surface Materials Page 10)	TRG (One Lock) + \$31 Trig Lock (Two Locks) + \$47 Trig Lock	T (One Lock) \$-15 (Two Locks) \$-30 Trig Key Alike
Build your complete Part Number here:															



Sample Part Number:	TRGCLATSDR45	.LD	N/A	.MD	.ZX2	.XZ4	.XZ4	.XZ2	.K	.TRG	.R
Total Cost \$1934 =	\$1887	+ N/C	+ N/C	+ N/C	+ N/C	+ N/C	+ N/C	+ N/C	+ N/C	+ \$47	+ N/C

Open Storage Credenza

All Shelves are fixed.

The upper storage units are 10 1/2" high and the bottom storage units are 11 3/4" high.

Trig Credenzas – Open Storage

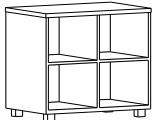
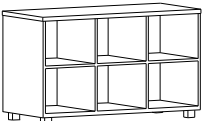
Depth	Dimensions		List Price		Catalog Number	Unit/ Shelf Color	Top Color	Top Edge Color	Leg Trim Color	
	Width	Height	1	2						
Open Storage 612										
20" (508)	30" (762)	26 3/4" (680)	\$ 1114	\$1164	TRGCOS30 TRGCOS36	Thermo-fused Laminate (See Surface Materials Page 10)	Thermo-fused Laminate (See Surface Materials Page 10)	Thermo-fused Laminate (See Surface Materials Page 10)	Standard Finish No Cost Premium Finish + \$13 (See Surface Materials Page 10)	
20" (508)	36" (914)	26 3/4" (680)	\$1204	\$1255						
										
Open Storage 612										
20" (508)	45" (1143)	26 3/4" (680)	\$1339	\$1410	TRGCOS45					
										
Build your complete Part Number here:						_ _ _ _ _	_	_	_	_

Sample Part Number:

<u>TRGCOS45</u>	<u>.ZX2</u>	<u>.XZ4</u>	<u>.XZ4</u>	<u>.Y</u>
-----------------	-------------	-------------	-------------	-----------

Total Cost \$1339 =

\$1339	+	N/C	+	N/C	+	N/C	+	N/C
--------	---	-----	---	-----	---	-----	---	-----

Freestanding Lateral

The Trig Freestanding Lateral includes full extension ball bearing slides, an interlock mechanism that allows only one drawer to open at a time, side-to-side filing bars, front-to-back filing bars and leveling glides. Drawers accommodate side-to-side, letter, A4, legal and EDP filing.

Optional locking available for drawers.

Units are intended for freestanding applications.

Units ship fully assembled except for 2" support legs.

Freestanding Pedestal

The Trig Freestanding Pedestal includes full extension ball bearing slides, side-to-side filing bars, front-to-back filing bars, and leveling glides. Drawers accommodate side-to-side letter, A4, legal and EDP filing.

Optional locking available for drawers.

Units are intended for freestanding applications.

Units ship fully assembled except for 2" support legs.

Trig Freestanding Lateral

Depth	Dimensions		List Price Thermofused Grade		Catalog Number	Pull Style	Unit Color	Top Color	Top Edge Color	Drawer Color	Leg Trim Color	Lock Type	Lock Option
	Width	Height	1	2									
20" (508)	30" (762)	26 ³ / ₄ " (680)	\$1394	\$1445	TRG612LAT20	No Cost Applied	Thermo-Fused Laminate	Thermo-Fused Laminate	Thermo-Fused Laminate	Thermo-Fused Laminate	Standard Finish No Cost	NL No Cost No Lock	R No Cost Trig Random
20" (508)	36" (914)	26 ³ / ₄ " (680)	\$1606	\$1656	TRG612LAT2036								



Trig Freestanding Pedestal

Depth	Dimensions		List Price Thermofused Grade		Catalog Number	Pull Style	Unit Color	Top Color	Top Edge Color	Drawer Color	Leg Trim Color	Lock Type	Lock Option
	Width	Height	1	2									
20" (508)	15 ¹ / ₂ " (394)	26 ³ / ₄ " (680)	\$1105	\$1135	TRG612PED20	MM Mod2							
						MD Modern							



Build your complete Part Number here:

---	---	---	---	---	---	---	---	---	---	---	---	---	---
-----	-----	-----	-----	-----	-----	-----	-----	-----	-----	-----	-----	-----	-----

Sample Part Number:

TRG612LAT20	.MD	.ZX2	.XZ2	.XZ2	.XZ4	.K	.TRG	.R
-------------	-----	------	------	------	------	----	------	----

Total Cost \$1425 =

\$1394	+	N/C	+	N/C	+	N/C	+	N/C	+	N/C	+	\$31	+	N/C
--------	---	-----	---	-----	---	-----	---	-----	---	-----	---	------	---	-----

Freestanding Double Door Storage

The Trig Freestanding Double Door Storage include hinged doors with optional locking. (Locking not available with aluminum door option) Unit comes with (1) shelf that adjusts vertically in 2 1/2" increments. Unit also includes leveling glides in each 2" support leg.

Units are intended for freestanding applications.

Units ship fully assembled except for 2" support legs.

Note: Trim color includes support legs and Framed Door option (FD) when selected.

Trig Bookcase

The bookcase unit includes one adjustable shelf. The shelf is 5/8" thick and adjust vertically in 2 1/2" (64) increments.

Shipped ready to assemble.

Trig Freestanding Double Door Storage

Depth	Dimensions		List Price Thermofused Grade		Catalog Number	Door Style	Framed Door Insert	Pull Style	Unit Color	Top Color	Top Edge Color	Door Color	Trim Color	Lock Type	Lock Option
	Width	Height	1	2											
20" (508)	30" (762)	26 3/4" (680)	\$1238	\$1289	TRGDD20	LD	Plexi-glass (01, 02)	No Cost Applied	Thermofused Laminate	Thermofused Laminate	Thermofused Laminate	Thermofused Laminate	Standard Finish No Cost	NL No Cost No Lock	R No Cost Trig Random
20" (508)	36" (914)	26 3/4" (680)	1398	1468	TRGDD2036	No Cost Laminate Door FD + \$787 Framed Door	Frosted Plexi-glass (E3A) + \$130 3-Form (E01-E03) + \$261 Not available with Framed Door (FD) option.	L Classic E Stream-line AZ Designer MM Mod2 MD Modern	(See Surface Materials Page 10)	(See Surface Materials Page 10)	(See Surface Materials Page 10)	Door Edge will match door color Specify only if LD selected	Premium Finish + \$13 (See Surface Materials Page 10)	TRG + \$31 Trig Lock	T \$-15 Trig Key Alike Note: Be sure to order core/key sets (TLCK) separately.
Build your complete Part Number here:															

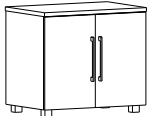

Trig Bookcases

Depth	Dimensions		List Price Thermofused Grade		Catalog Number	Unit/Shelf Color	Top Color	Top Edge Color	Leg Trim Color
	Width	Height	1	2					
20" (508)	30" (762)	26 3/4" (680)	\$ 837	\$ 887	TRGCBC30	Thermofused Laminate	Thermofused Laminate	Thermofused Laminate	Standard Finish No Cost
	36" (914)		927	977	TRGCBC36	(See Surface Materials Page 10)	(See Surface Materials Page 10)	(See Surface Materials Page 10)	Premium Finish + \$13 (See Surface Materials Page 10)
Build your complete Part Number here:									



Sample Part Number:

TRGCBC30	.XZY	.XZY	.XZY	.K
----------	------	------	------	----

Total Cost \$837 =

\$837	+	N/C	+	N/C	+	N/C	+	N/C
-------	---	-----	---	-----	---	-----	---	-----

Bench-Height Storage

The Trig Bench-Height Storage is available in five different widths. Lateral units include full extension ball bearing slides, an interlock mechanism that allows only one drawer to open at a time, side-to-side and front-to-back filing bars, and leveling glides.

Optional locking available on drawers.

45" wide Lateral Open Shelf unit comes with (1) shelf that adjusts vertically in 2 1/2" increments.

Units are intended for freestanding applications.

Units ship fully assembled except for 2" support legs.

Trig Bench-Height Storage

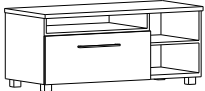
Dimensions Depth Width Height	Lock	List Price Thermofused Grade		Catalog Number	Pull Style	Unit/Shelf Color	Top Color	Top Edge Color	Drawer Front Color	Trim Color	Lock Type	Lock Option
		1	2									
(12) Lateral												
20" (508) 30" (762) 21" (533)	1 Lock	\$1356	\$1406	TRGBFLAT30	No Cost Applied	Thermofused Laminate	Thermofused Laminate	Thermofused Laminate	Thermofused Laminate	Standard Finish No Cost	NL No Cost No Lock	R No Cost Trig Random
20" (508) 36" (914) 21" (533)	1 Lock	1514	1565	TRGBFLAT36								
												
(12) Lateral w/ Open Shelf RH												
20" (508) 45" (1143) 21" (533)	1 Lock	\$1645	\$1716	TRGBFLATOSR45	AZ Designer	(See Surface Materials Page 10)	(See Surface Materials Page 10)	(See Surface Materials Page 10)	Drawer Edge will match Drawer Color	Premium Finish + \$13	TRG (One Lock) + \$31 Trig Lock	T (One Lock) \$-15
20" (508) 48" (1219) 21" (533)	1 Lock	1688	1758	TRGBFLATOSR48								
20" (508) 60" (1524) 21" (533)	1 Lock	1860	1930	TRGBFLATOSR60								
(12) Lateral w/ Open Shelf LH												
20" (508) 45" (1143) 21" (533)	1 Lock	\$1645	\$1716	TRGBFLATOSL45	MM Mod2	(See Surface Materials Page 10)	(See Surface Materials Page 10)	(See Surface Materials Page 10)	Drawer Edge will match Drawer Color	Premium Finish + \$13	TRG (One Lock) + \$31 Trig Lock	T (One Lock) \$-15
20" (508) 48" (1219) 21" (533)	1 Lock	1688	1758	TRGBFLATOSL48								
20" (508) 60" (1524) 21" (533)	1 Lock	1860	1930	TRGBFLATOSL60								
												
Right-Hand Shown												
Build your complete Part Number here:												

Sample Part Number:

TRGBFLATOSL60	.MD	.XZ3	.XZ3	.XZ3	.XZ4	.K	.TRG	.T
---------------	-----	------	------	------	------	----	------	----

Total Cost \$1876 =

\$1860	+	N/C	+	N/C	+	N/C	+	N/C	+	N/C	+	\$31	-	\$-15
--------	---	-----	---	-----	---	-----	---	-----	---	-----	---	------	---	-------

Overview & Order Information
 Statement of Line
 Surface Materials
 Desks & Work Surfaces
 Screens & Modesties
 Storage
 Benching Electrical
 Electrical
 Accessories
 Terms, Policies & Index

Bench-Height Storage (continued)

Bench-Height Cushion

Trig Bench-Height Cushion includes upholstered cushion and four attached velcro tabs to affix cushion to top of Bench-Height Storage Units.

Trig Bench-Height Storage (continued)

Depth	Dimensions		Lock	1	2	Catalog Number	Pull Style	Unit/ Shelf Color	Top Color	Top Edge Color	Drawer Front Color	Trim Color	Lock Type	Lock Option
	Width	Height												
2 (12) Lateral 20" (508)	60" (1524)	21" (533)	2 Locks	\$2099	\$2194	TRGBF2LAT60	No Cost Applied L Classic E Stream-line	Thermo-fused Laminate (See Surface Materials Page 10)	Thermo-fused Laminate (See Surface Materials Page 10)	Thermo-fused Laminate (See Surface Materials Page 10)	Thermo-fused Laminate Drawer Edge will match Drawer Color	Standard Finish No Cost Premium Finish + \$13 (See Surface Materials Page 10)	NL No Cost No Lock TRG (Two Locks) + \$47 Trig Lock	R No Cost Trig Random T (Two Locks) Trig Key Alike <small>Note: Be sure to order core/key sets (TLCK) separately.</small>
2 (12) Lateral w/ Center Shelf 20" (508)	72" (1829)	21" (533)	2 Locks	\$2264	\$2390	TRGBF2LATCS72	AZ Designer MM Mod2 MD Modern							
20" (508)	75" (1905)	21" (533)	2 Locks	2306	2432	TRGBF2LATCS75								
Build your complete Part Number here:														

Trig Bench-Height Cushion

Width	Dimensions		List Price Fabric Grade											Catalog Number	Seating Fabric Color
	Depth	Height	A	B	C	D	E	F	G	H	I	J	K		
15" (381)	20" (508)	1" (25)	\$302	\$315	\$333	\$354	\$374	\$394	\$420	\$447	\$468	\$486	\$506	TRGBC2015	See Seating price book Surface Material Section
30" (762)			366	371	397	424	458	503	562	622	648	675	708	TRGBC2030	

Build your complete Part Number here:

Sample Part Number:

TRGBF2LATCS75	.MD	.XZ3	.XZ3	.XZ3	.XZ4	.K	.TRG	.T
---------------	-----	------	------	------	------	----	------	----

Total Cost \$2323 =

\$2306	+	N/C	+	N/C	+	N/C	+	N/C	+	N/C	+	N/C	+	\$47	+	\$-30
--------	---	-----	---	-----	---	-----	---	-----	---	-----	---	-----	---	------	---	-------

Trig Bench-Height Bookcase

The book case unit includes one adjustable shelf. The shelf is 5/8" thick and adjusts vertically in 2 1/2" (64) increments. The bookcase unit is designed to accommodate standard binders on one of the shelves.

Shipped ready to assemble.

Trig Bench-Height Bookcase

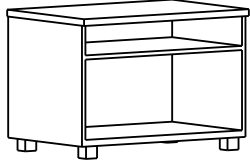
Depth	Dimensions Width	Height	List Price Thermofused Grade		Catalog Number	Unit/Shelf Color	Top Color	Top Edge Color	Leg Trim Color
			1	2					
20" (508)	30" (762) 36" (1219)	21" (533)	\$771 861	\$821 911	TRGBFBC30 TRGBFBC36	Thermofused Laminate (See Surface Materials Page 10)	Thermofused Laminate (See Surface Materials Page 10)	Thermofused Laminate (See Surface Materials Page 10)	Standard Finish No Cost Premium Finish + \$13 (See Surface Materials Page 10)
			Build your complete Part Number here:		-----	---	---	---	--

Sample
Part Number:

TRGBFBC30	.XZY	.XZY	.XZY	.K				
\$771	+	N/C	+	N/C	+	N/C	+	N/C

Total Cost \$771 =

Combination Storage

The Trig Combination Storage unit combines the functionality of a lateral and pedestal with added storage of shelves. Units are intended to be placed at the aisle side of a workstation to provide storage and privacy.

The Laterals include full extension ball bearing slides, an interlock mechanism that allows only one drawer to open at a time, side-to-side and front-to-back filing bars and leveling glides. Drawers accommodate side-to-side letter, A4, legal and EDP filing.

Available accessories include Marker Board or Tackboard for addition to the aisle side of the units.

Units are intended for freestanding applications, or can be used as work surface support if used in combination with option Trig Work Surface Support Brackets.

Unit ships fully assembled.

Trig Combination Storage

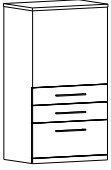
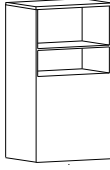
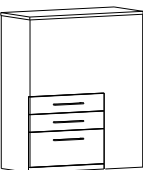
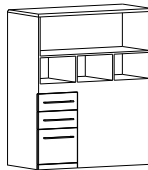
Depth	Dimensions		Lock	List Price Thermofused Grade		Catalog Number	Pull Style	Unit Color	Top Color	Top Edge Color	Drawer Color	Lock Type	Lock Option	Work Surface Bracket
	Width	Height		1	2									
Aisle Side 6612 Lateral - User Side Open Shelves														
20" (508)	30" (762)	53 ³ / ₄ " (1365)	1 Lock	\$1896	\$1991	TRGCSLATOS30	No Cost Applied	Thermofused Laminate	Thermofused Laminate	Thermofused Laminate	Thermofused Laminate	NL No Cost No Lock	R No Cost Trig Random	BN No Cost No Bracket
 Aisle Side		 User Side												
Aisle Side 6612 Lateral - User side 6612 ped, and open hutch storage RH														
20" (508)	45" (1143)	53 ³ / ₄ " (1365)	2 Locks	\$3169	\$3294	TRGCSOSR45	L Classic	(See Surface Materials Page 10)	(See Surface Materials Page 10)	(See Surface Materials Page 10)	Drawer Edge will match Drawer Color	TRG (One Lock) + \$31 Trig Lock	T (One Lock) \$-15	BY + \$58 Two Brackets
Aisle Side 6612 Lateral - User side 6612 ped, and open hutch storage LH														
20" (508)	45" (1143)	53 ³ / ₄ " (1365)	2 Locks	3169	3294	TRGCSOSL45	E Stream-line					(Two Locks) + \$47 Trig Lock	(Two Locks) \$-30 Trig Key Alike	Note: Be sure to order core/key sets (TLCK) separately.
 Aisle Side		 User Side												
Left-Hand Shown				Build your complete Part Number here:										

Sample Part Number:

TRGCSOSR45	.MD	.XZ2	.XZ2	.XZ2	.XZ4	.TRG	.R	.BN
------------	-----	------	------	------	------	------	----	-----

Total Cost \$3216 =

\$3169	+	N/C	+	N/C	+	N/C	+	N/C	+	N/C	+	\$47	+	N/C	+	N/C
--------	---	-----	---	-----	---	-----	---	-----	---	-----	---	------	---	-----	---	-----

Combination Storage Continued

The Double Doors include hinged doors with optional locking. (Locking not available with aluminum doors)
Unit comes with 2 shelves that adjust vertically in 2 1/2" increments.

Trig Combination Storage

Dimensions Depth Width Height	List Price Thermofused Grade		Catalog Number	Door Style	Framed Door Insert	Pull Style	Unit Color	Top Color	Top Edge Color	Door Color	Framed Door Trim Color	Lock Type	Lock Option	Work Surface Bracket
	1	2												
Aisle Side Double Door - User Side Open Shelves 20" (508) 30" (762) 53 3/4" (1365)	\$1751	\$1876	TRGCSDDOS30	LD No Cost Laminated Door FD + \$787 Framed Door	Plexi-glass (01, 02) No Cost Frost-glass Plexi-glass (E3A) + \$130 3-Form (E01-E03) + \$261 MM Mod2 MD Modern Not available with Frame Door (FD) option	No Cost Applied L Classic E Streamline AZ Designer MM Mod2 MD Modern	Thermofused Laminate	Thermofused Laminate	Thermofused Laminate	Thermofused Laminate	No Cost (See Surface Materials Page 10)	NL No Cost No Lock TRG + \$31 Trig Lock	R No Cost No Random T \$-15 Trig Key Alike Note: Be sure to order core/key sets (TLCK) separately.	BN No Cost No Bracket BY + \$58 Two Brackets
Build your complete Part Number here:				---	---	---	---	---	---	---	---	---	---	---

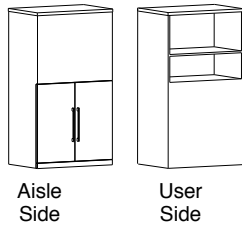

Sample Part Number:

TRGCSDDOS30	.FD	.E3A	N/A	.XZ2	.XZ2	.XZ2	N/A	.XZ2	.NL	N/A	.BN
-------------	-----	------	-----	------	------	------	-----	------	-----	-----	-----

Total Cost \$2668 =

\$1751	+	\$787	+	\$130	+	N/C	+	N/C	+	N/C	+	N/C	+	N/C	+	N/C	+	N/C	+	N/C	+	N/C
--------	---	-------	---	-------	---	-----	---	-----	---	-----	---	-----	---	-----	---	-----	---	-----	---	-----	---	-----

Pedestal Shelf Combination Storage

The Trig Pedestal Shelf Combination Storage combines the functionality of a pedestal with the added storage of shelves. The storage unit is available in Right- and Left- Hand versions. The Right Hand version is intended for placement on the right-hand of a workstation with the shelves facing inward. The Left-Hand version is intended for placement on the left-hand of a workstation with the shelves facing inward. The 6612 Pedestal includes full extension ball bearing slides, side-to-side and front-to-back filing bars and leveling glides. Drawers accommodate

side-to-side letter, A4, legal and EDP filing. The shelf storage includes one adjustable shelf that adjusts vertically in 2 1/2" increments.

Available accessories include a Marker Board or Tackboard that can be added to the aisle side of the unit. Option locking available on pedestal drawers.

Units are intended for freestanding applications, or can be used as work surface support if used in combination with option Trig Work Surface Support Brackets.

Unit ships fully assembled.

Trig Pedestal Shelf Combination Storage – Right-Hand

Depth	Dimensions		List Price Thermofused Grade		Catalog Number	Pull Style	Unit Color	Top Color	Top Edge Color	Drawer Front Color	Lock Type	Lock Option	Work Surface Bracket
	Width	Height	1	2									
6612 Ped and Open Shelves on Side													
20" (508)	15 1/2" (394)	47 3/4" (1213)	\$ 1370	\$ 1441	TRGCS6612OSR20	No Cost Applied	Thermo-fused Laminate	Thermo-fused Laminate	Thermo-fused Laminate	Thermo-fused Laminate	NL No Cost No Lock	R No Cost Trig Random	BN No Cost No Bracket
24" (610)	15 1/2" (394)	47 3/4" (1213)	1459	1530	TRGCS6612OSR24	L Classic	(See Surface Materials Page 10)	(See Surface Materials Page 10)	(See Surface Materials Page 10)	Drawer Edge will match Drawer Color	TRG + \$31 Trig Lock	T \$-15 Trig Key Alike	BY + \$58 Two Brackets
30" (762)	15 1/2" (394)	47 3/4" (1213)	1529	1599	TRGCS6612OSR30								

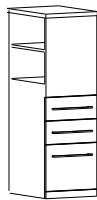

Trig Pedestal Shelf Combination Storage – Left-Hand

Depth	Dimensions		List Price Thermofused Grade		Catalog Number	Pull Style	Unit Color	Top Color	Top Edge Color	Drawer Front Color	Lock Type	Lock Option	Work Surface Bracket
	Width	Height	1	2									
6612 Ped and Open Shelves on Side													
20" (508)	15 1/2" (394)	47 3/4" (1213)	\$1370	\$1441	TRGCS6612OSL20	MM Mod2							
24" (610)	15 1/2" (394)	47 3/4" (1213)	1459	1530	TRGCS6612OSL24								
30" (762)	15 1/2" (394)	47 3/4" (1213)	1529	1599	TRGCS6612OSL30								

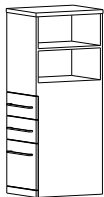

Build your complete Part Number here:

Sample Part Number:

TRGCS6612OSR20	.MD	.XZ2	.XZ2	.XZ2	.XZ4	.TRG	.R	.BN
----------------	-----	------	------	------	------	------	----	-----

Total Cost \$1401 =

\$1370	+ N/C	+ N/C	+ N/C	+ N/C	+ N/C	+ \$31	+ N/C	+ N/C
--------	-------	-------	-------	-------	-------	--------	-------	-------

Marker Boards

The Trig Marker Board provides a white, writing surface for use with dry erase markers. Marker Boards can be mounted to the aisle side of Combination Storage units.

Tackboards

The Trig Tackboard can be mounted to the aisle side of Combination Storage units. The Tackboard has a tackable panel fabric front and velcro attachment tabs.

Width	Usage
12	Front of Pedestal Shelf Combination Storage
16	Aisle Side 20" Deep Ped Shelf Combination Storage
20	Aisle Side 24" Deep Ped Shelf Combination Storage
24	Aisle Side 30" Deep Ped Shelf or 30" Wide Combination Storage
36	Aisle Side 45" Wide Combination Storage



Trig Marker Boards

Dimensions		List Price	Catalog Number
Width	Height		
12" (305)	17" (432)	\$206	TRGMB1217
16" (406)	17" (432)	247	TRGMB1617
20" (508)	17" (432)	309	TRGMB2017
24" (610)	17" (432)	358	TRGMB2417
36" (914)	17" (432)	454	TRGMB3617

Build your complete Part Number here: _____



Trig Tackboards

Dimensions		List Price Fabric Grade						Catalog Number	Fabric Color
Width	Height	0/1	2	3	4	5	6		
12" (305)	17" (432)	\$ 96	\$ 122	\$ 135	\$ 148	\$ 164	\$ 180	TRGTB1217	(See Surface Materials Page 7)
16" (406)	17" (432)	102	128	141	154	170	186	TRGTB1617	
20" (508)	17" (432)	110	136	149	162	178	194	TRGTB2017	
24" (610)	17" (432)	124	150	163	176	192	213	TRGTB2417	
36" (914)	17" (432)	137	163	176	189	205	233	TRGTB3617	

Build your complete Part Number here: _____

Sample Part Number:

TRGMB1217	N/A
-----------	-----

Total Cost \$206 =

\$206	+	N/C
-------	---	-----

Storage Tower with Double-Door

The Trig Storage Tower with Double-Doors include hinged double doors, with three shelves that adjust vertically in 2 1/2" increments, and leveling glides.

Optional locking and aluminum doors available (Locking not available in combination with aluminum doors)

Units are intended for freestanding applications.

Units ship fully assembled.

Trig Storage Tower with Double-Door

Depth	Dimensions		List Price Thermofused Grade		Catalog Number	Door Style	Framed Door Insert	Pull Style	Unit Color	Top Color	Top Edge Color	Door Color	Framed Door Trim Color	Lock Type	Lock Option
	Width	Height	1	2											
20" (508)	30" (762)	53 ^{3/4} " (1365)	\$1860	\$1985	TRGTSDD54	LD	Plexi-glass (01, 02)	No Cost Applied	Thermo-fused Laminate	Thermo-fused Laminate	Thermo-fused Laminate	Thermo-fused Laminate	No Cost	NL No Cost No Lock	R No Cost Trig Random
20" (508)	30" (762)	65 ^{3/4} " (1670)	2060	2185	TRGTSDD66	No Cost Laminate Door	Frosted Plexi-glass (E3A) \$261	L Classic	(See Surface Materials Page 10)	(See Surface Materials Page 10)	(See Surface Materials Page 10)	Door Edge will match door color	(See Surface Materials Page 10) Specify only if FD selected	TRG + \$31 Trig Lock	T \$-15 Trig Key Alike
						FD + \$1050 Framed Door	3-Form (E01-E03) + \$524	E Stream-line				Specify only if LD selected			Note: Be sure to order core/key sets (TLCK) separately.
								AZ Designer							
								MM Mod2							
								MD Modern							
								Not available with Framed Door (FD) option							
Build your complete Part Number here:															

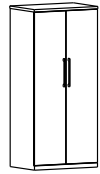

Sample Part Number:

TRGTSDD54	.LD	N/A	.MD	.XZ2	.XZ2	.XZ2	.XZ4	N/A	.TRG	.R
-----------	-----	-----	-----	------	------	------	------	-----	------	----

Total Cost \$1891 =

\$1860	+	N/C	+	N/C	+	N/C	+	N/C	+	N/C	+	N/C	+	N/C	+	\$31	+	N/C
--------	---	-----	---	-----	---	-----	---	-----	---	-----	---	-----	---	-----	---	------	---	-----

Lateral, Double Door Storage Tower

The Storage Towers are available with two lateral drawer configurations: 12/12 with 12" drawers or 6/6/12 with two 6" drawers and one 12" drawer.

Lateral drawers includes full extension ball bearing slides, an interlock mechanism that allows only one drawer to open at a time, side-to-side and front-to-back filing bars. Pre-installed counterbalance weights included.

Double-Door storage includes hinged double doors, with two shelves that adjust vertically in 2 1/2" increments.

Optional locking available for both double door and lateral portion. (Lock option not available with framed doors)

Units include leveling glides.

Units ship fully assembled.

Single lock can be specified for laterals.

Trig Lateral, Double-Door Storage Tower

Depth	Dimensions		List Price Thermofused Grade		Catalog Number	Door Style	Framed Door Insert	Pull Style	Unit Color	Top Color	Top Edge Color	Drawer/Door Color	Framed Door Trim Color	Lock Type	Lock Option		
	Width	Height	1	2													
6612 Lateral and double-door storage (2 adjustable shelves)																	
20" (508)	30" (762)	53 1/4" (1365)	\$2392	\$2487	TRGTS6612DD54 TRGTS6612DD66	LD No Cost Laminate Door FD + \$787 Framed Door	Plexi-glass (01, 02) No Cost Frosted Plexi-glass (E3A) + \$130 3-Form (E01-E03) + \$261	L Classic E Streamline AZ Designer MM Mod2 MD Modern	(See Surface Materials Page 6)	(See Surface Materials Page 6)	(See Surface Materials Page 6)	Thermo-fused Laminate	Thermo-fused Laminate	Thermo-fused Laminate	No Cost Standard or Premium Finish (See Surface Materials Page 10) Specify for Lateral/Laminate door only	NL No Cost No Lock TRG (One Locks) + \$31 Trig Lock (Two Locks) + \$47 Trig Lock	R No Cost Trig Random T (One Lock) \$-15 (Two Locks) \$-30 Trig Key Alike Note: Be sure to order core/key sets (TLCK) separately.
20" (508)	30" (762)	65 3/4" (1670)	2479	2604													
1212 Lateral and double-door storage(2 adjustable shelves)																	
20" (508)	30" (762)	53 1/4" (1365)	\$2293	\$2418	TRGTS1212DD54 TRGTS1212DD66	LD No Cost Laminate Door FD + \$787 Framed Door	Plexi-glass (01, 02) No Cost Frosted Plexi-glass (E3A) + \$130 3-Form (E01-E03) + \$261	L Classic E Streamline AZ Designer MM Mod2 MD Modern	(See Surface Materials Page 6)	(See Surface Materials Page 6)	(See Surface Materials Page 6)	Thermo-fused Laminate	Thermo-fused Laminate	Thermo-fused Laminate	No Cost Standard or Premium Finish (See Surface Materials Page 10) Specify for Lateral/Laminate door only	NL No Cost No Lock TRG (One Locks) + \$31 Trig Lock (Two Locks) + \$47 Trig Lock	R No Cost Trig Random T (One Lock) \$-15 (Two Locks) \$-30 Trig Key Alike Note: Be sure to order core/key sets (TLCK) separately.
20" (508)	30" (762)	65 3/4" (1670)	2340	2435													
Build your complete Part Number here:																	

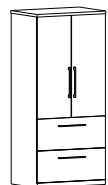
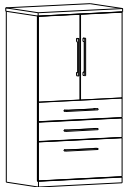

Sample Part Number:

TRGTS6612DD54	.LD	N/A	.MD	.XZ2	.XZ2	.XZ2	.XZ4	N/C	.TRG	.R
---------------	-----	-----	-----	------	------	------	------	-----	------	----

Total Cost \$2439 =

\$2392	+	N/C	+	N/C	+	N/C	+	N/C	+	N/C	+	N/C	+	N/C	+	N/C	+	\$47	+	N/C
--------	---	-----	---	-----	---	-----	---	-----	---	-----	---	-----	---	-----	---	-----	---	------	---	-----

Lateral, Open Shelf Storage Tower
 Trig Lateral, Open Shelf Storage Tower are available in two lateral drawer configurations: 12/12 with two 12" drawers or 6/6/12 with two 6" drawers and one 12" drawer.

Lateral drawers includes full extension ball bearing slides, an interlock mechanism that allows only one drawer to open at a time, side-to-side and front-to-back filing bars.

Display Towers
Display Tower with Drawers and Open Shelves The 6" Drawers have full extension ball bearing slides. Locking not available on 6" Drawers.

Display Tower with Open Shelves
 Features include three shelves that adjust vertically in 2 1/2" increments.

All units are intended for freestanding applications. All units ship fully assembled.

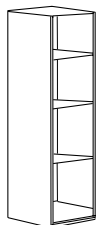
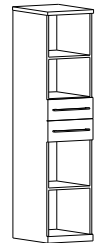

Trig Lateral, Open Shelf Storage Tower

Dimensions Depth Width Height	List Price Thermofused Grade		Catalog Number	Pull Style	Unit Color	Top Color	Top Edge Color	Drawer Front Color	Lock Type	Lock Option
	1	2								
6612 Lateral and 2 Open Shelves				No Cost Applied	Thermo-fused Laminate	Thermo-fused Laminate	Thermo-fused Laminate	Thermo-fused Laminate	NL No Cost No Lock	R No Cost Pack Random
20" (508) 30" (762) 53 3/4" (1365)	\$2202	\$2296	TRGTS6612OS54							
20" (508) 30" (762) 65 3/4" (1670)	2306	2401	TRGTS6612OS66	L Classic						
1212 Lateral and 2 Open Shelves				E Stream-line	(See Surface Materials Page 10)	(See Surface Materials Page 10)	(See Surface Materials Page 10)	Drawer Edge will match Drawer Color	TRG (One Lock) + \$31	T \$-15 Trig Key Alike
20" (508) 30" (762) 53 3/4" (1365)	\$2099	\$2194	TRGTS1212OS54							
20" (508) 30" (762) 65 3/4" (1670)	2169	2263	TRGTS1212OS66	AZ Designer						

Trig Display Towers

Dimensions Depth Width Height	List Price Thermofused Grade		Catalog Number	Pull Style
	1	2		
Display Tower w/ (2) 6" Drawers and Open Shelves				MM Mod2
20" (508) 15" (381) 53 3/4" (1365)	\$1425	\$1496	TRGTS66OS54	MD Modern
20" (508) 15" (381) 65 3/4" (1670)	1622	1692	TRGTS66OS66	
Display Tower with Open Shelves				
20" (508) 15" (381) 53 3/4" (1365)	\$1202	\$1272	TRGTSOS54	
20" (508) 15" (381) 65 3/4" (1670)	1364	1434	TRGTSOS66	

Build your complete Part Number here:

---	---	---	---	---	---	---	---	---	---
-----	-----	-----	-----	-----	-----	-----	-----	-----	-----

Sample Part Number:

TRGTS6612OS54	.MD	.XZ2	.XZ2	.XZ2	.XZ2	N/L	N/A
----------------------	------------	-------------	-------------	-------------	-------------	------------	------------

Total Cost \$2202 =

\$2202	+	N/C	+	N/C	+	N/C	+	N/C	+	N/C	+	N/C	+	N/C	+	N/C
--------	---	-----	---	-----	---	-----	---	-----	---	-----	---	-----	---	-----	---	-----

Trig Wardrobe Storage Tower and Wardrobe Storage Tower with Bookcase

The Wardrobe Storage Tower provides, wardrobe, drawer and cupboard storage in a single cabinet. Each of these storage areas can be locked independently to allow for varying levels of security. Wardrobe Storage Towers are available in either Right-Hand version with the wardrobe on the right side or a Left-Hand version with the wardrobe on the left side.

Wardrobe Storage Towers have adjustable leveling glides. The wardrobe unit includes a wardrobe bar and one adjustable shelf. The cupboard unit includes two adjustable shelves. The bookcase unit and cupboard unit includes two adjustable shelves. Shelves adjust vertically in 2 1/2" (64) increments. The pedestals have full extension ball bearing slides on both the 6" and 12" drawers.

Unit ships fully assembled.

When the key-alike lock option "T" is chosen a "disposable" core is assembled in the filing unit to temporarily secure the drawers and doors for transit. The "disposable" core must be field replaced with a Trig Core/Key set in order for the Trig filing unit to lock. The Core/Key set (CLCK) must be order separately or by using the keying order form. Check Customer Care for availability.

Trig Wardrobe Storage Tower

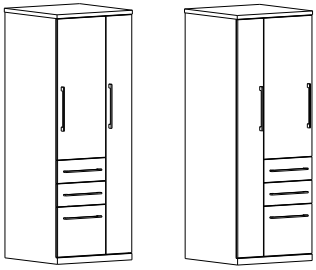
Depth	Dimensions		List Price Thermofused Grade		Catalog Number	Pull Style	Unit Color	Top Color	Top Edge Color	Drawer Front Color	Lock Type	Lock Option
	Width	Height	1	2								
Right Handed Units												
24" (610)	24" (610)	66" (1676)	\$2299 2350	\$2424 2476	TRGWSTR661212 TRGWSTR666612	No Cost Applied	Thermo-fused Laminate (See Surface Materials Page 10)	Thermo-fused Laminate (See Surface Materials Page 10)	Thermo-fused Laminate (See Surface Materials Page 10)	Thermo-fused Laminate Door Edge will match door color	NL No Cost No Lock	R NoCost Trig Random
Left Handed Units												
24" (610)	24" (610)	66" (1676)	\$2299 2350	\$2424 2476	TRGWSTL661212 TRGWSTL666612	L Classic E Stream-line AZ Designer MM Mod2 MD Modern	(See Surface Materials Page 10)	(See Surface Materials Page 10)	(See Surface Materials Page 10)	TRG (three Lock) + \$67 Trig Lock	T (three Lock) \$-45 Trig Key Alike	*Note: Be sure to order Core/Key Sets (TLCK) separately
												

Trig Wardrobe Storage Tower with Bookcase

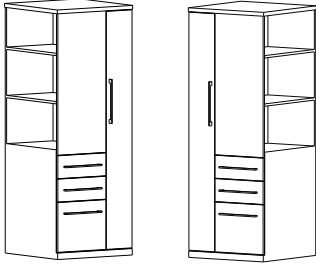
Depth	Dimensions		List Price Thermofused Grade		Catalog Number	Pull Style	Unit Color	Top Color	Top Edge Color	Drawer Front Color	Lock Type	Lock Option	
	Width	Height	1	2									
Right Handed Units													
24" (610)	24" (610)	66" (1676)	\$2403 2456	\$2528 2581	TRGBCSTR661212 TRGBCSTR666612						NL No Cost No Lock	NoCost Trig Random	
Left Handed Units													
24" (610)	24" (610)	66" (1676)	\$2403 2456	\$2528 2581	TRGBCSTL661212 TRGBCSTL666612						TRG (two Lock) + \$47 Trig Lock	T (two Lock) \$-30 Trig Key Alike	*Note: Be sure to order Core/Key Sets (TLCK) separately
													

Build your complete Part Number here:

Sample Part Number:

TRGWSTR661212	.MD	.XZ3	.XZ3	.XZ3	.XZ3	.TRG	.R
---------------	-----	------	------	------	------	------	----

Total Cost \$2366 =

\$2299	+	N/C	+	N/C	+	N/C	+	N/C	+	N/C	+	\$67	+	N/C
--------	---	-----	---	-----	---	-----	---	-----	---	-----	---	------	---	-----

Display Towers Continue

Display Tower with Door features include a hinged door, with three shelves that adjust vertically in 2 1/2" increments. Optional laminate or framed aluminum doors available. (Lock option not available with aluminum doors)

Trig Display Tower with Door

Dimensions			List Price Thermofused Grade		Catalog Number	Door Style	Framed Door Insert	Pull Style	Unit Color	Top Color	Top Edge Color	Door Front Color	Framed Door Front Color	Lock Type	Lock Option
Depth	Width	Height	1	2											
Display Tower with Door RH						LD		No Cost Applied					No Cost	NL	R
20" (508)	15" (381)	53 3/4" (1365)	\$1314	\$1384	TRGTSSDR54	Plexi-glass (01, 02)			Ther-mo-fused Laminate	Ther-mo-fused Laminate	Ther-mo-fused Laminate	Ther-mo-fused Laminate	Standard or Premium Finish	No Cost	No Cost
20" (508)	15" (381)	65 3/4" (1670)	1487	1581	TRGTSSDR66	Laminate Door		L Classic	(See Surface Materials Page 10)	(See Surface Materials Page 10)	(See Surface Materials Page 10)	Door Edge will match door color	(See Surface Materials Page 10)	No Lock	Trig Random
Display Tower with Door LH						FD	Frosted	E Streamline						TRG	T
20" (508)	15" (381)	53 3/4" (1365)	\$1314	\$1384	TRGTSSDL54	+ \$524 Framed Door	Plexi-glass (E3A) + \$130	AZ Designer	(See Surface Materials Page 10)	(See Surface Materials Page 10)	(See Surface Materials Page 10)	Door Edge will match door color	(See Surface Materials Page 10)	TRG + \$31	\$-15
20" (508)	15" (381)	65 3/4" (1670)	1487	1581	TRGTSSDL66		3-Form (E01-E03) + \$261	MM Mod2				Specified only if LD selected	Specify only if FD selected	Trig Lock	Trig Key Alike
 <p>Right-Hand Shown</p>							MD Modern								
Build your complete Part Number here:															

Note: Be sure to order core/key sets (TLCK) separately.

Sample Part Number:

TRGTSSDR54	.FD	.E3A	MM	.XZ2	.XZ2	.XZ2	N/A	.K	.NL	N/A
------------	-----	------	----	------	------	------	-----	----	-----	-----

Total Cost \$1968 =

\$1314	+	\$524	+	\$130	+	N/C	+	N/C	+	N/C	+	N/C	+	N/C	+	N/C	+	N/C	+	N/C
--------	---	-------	---	-------	---	-----	---	-----	---	-----	---	-----	---	-----	---	-----	---	-----	---	-----

Trig Wardrobe Display Tower

The Wardrobe Display Tower features include a hinged locking door, one shelf, full width wardrobe bar and leveling glides. Optional laminate or framed aluminum door available. (Lock option not available with framed aluminum door). Wardrobe Display Towers are available in either Right-Hand version with the wardrobe opening to the right side or a Left-Hand version with the wardrobe opening to the left side.

Wardrobe Display Tower has adjustable leveling glides.

Units ship fully assembled.

Trig Wardrobe Display Tower

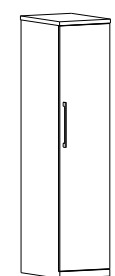
Depth	Dimensions		List Price Thermofused Grade		Catalog Number	Door Style	Framed Door Insert	Pull Style	Unit Color	Top Color	Top Edge Color	Door Front Color	Framed Door Front Color	Lock Type	Lock Option
	Width	Height	1	2											
Right Handed															
20" (508)	15" (381)	53 ³ / ₄ " (1365) 65 ³ / ₄ " (1670)	\$1188 1355	\$1258 1449	TRGTSWRR54 TRGTSWRR66	LD No Cost Laminate Door	Plexi-glass (01, 02) No Cost	No Cost Applied L Classic	Thermo-fused Laminate (See Surface Materials Page 10)	Thermo-fused Laminate (See Surface Materials Page 10)	Thermo-fused Laminate (See Surface Materials Page 10)	Thermo-fused Laminate Door Edge will match Door Color Specify only if LD Selected	No Cost Standard or Premium Finish (See Surface Materials Page 10) Specify only if FD selected	NL No Lock	R No-Cost Trig Random T (one Lock) \$-15 Trig Key Alike
Left Handed															
20" (508)	15" (381)	53 ³ / ₄ " (1365) 65 ³ / ₄ " (1670)	\$1188 1355	\$1258 1449	TRGTSWRL54 TRGTSWRL66	FD + \$524 Framed Door	Frosted Plexi-glass (E3A) + \$130 3-Form (E01-E03) + \$261	E Streamline AZ Designer MM Mod2 MD Modern	Thermo-fused Laminate (See Surface Materials Page 10)	Thermo-fused Laminate (See Surface Materials Page 10)	Thermo-fused Laminate (See Surface Materials Page 10)	Thermo-fused Laminate Door Edge will match Door Color Specify only if LD Selected	No Cost Standard or Premium Finish (See Surface Materials Page 10) Specify only if FD selected	NL No Lock	R No-Cost Trig Random T (one Lock) \$-15 Trig Key Alike
					 <p>Right-Hand Shown</p>										
Build your complete Part Number here:						---	---	---	---	-	-	-	-	-	---

Sample Part Number:

TRGTSWRR54	.FD	.E3A	.MM	.XZ2	.XZ2	.XZ2	N/A	.K	.NL	N/A
------------	-----	------	-----	------	------	------	-----	----	-----	-----

Total Cost \$1842 =

\$1188	+	\$524	+	\$130	+	N/C	+	N/C	+	N/C	+	N/C	+	N/C	+	N/C	+	N/C
--------	---	-------	---	-------	---	-----	---	-----	---	-----	---	-----	---	-----	---	-----	---	-----

Under Desk Lateral Support Storage

Trig Under Desk Lateral Support Storage is available in three depths. The Lateral includes full extension ball bearing slides, an interlock mechanism that allows only one drawer to open at a time, side-to-side and front to back filing bars and leveling glides. Drawers accommodate side-to-side letter, A4, legal and EDP filing.

Trig Under Desk Lateral Support Storage is pre-drilled to accept a 1" riser (included) for mounting under the desk (mounting screws included).

Optional locking available for drawers.

Units are intended for work surface support applications.

Ships fully assembled except 2" support leg.

Under Desk Pedestal Support Storage

Trig Under Desk Pedestals include a 1" riser for mounting under the desk. Pedestals have full extension ball bearing slides, side-to-side and front to back filing bars and leveling glides.

Optional locking available for drawers.

Ships fully assembled except 2" support leg.

Trig Under Desk Lateral Support Storage

Depth	Dimensions		List Price Thermofused Grade		Catalog Number	Pull Style	Unit Color	Top Color	Top Edge Color	Drawer Color	Leg Trim Color	Lock Type	Lock Option
	Width	Height	1	2									
20" (508)	30" (762)	27 ³ / ₄ " (705)	\$1412	\$1463	TRGUDLAT20	No Cost Applied	Thermofused Laminate	Thermofused Laminate	Thermofused Laminate	Thermofused Laminate	Standard Finish No Cost	NL No Cost No Lock	R No Cost Trig Random
24" (610)	30" (762)	27 ³ / ₄ " (705)	1508	1578	TRGUDLAT24								
30" (762)	30" (762)	27 ³ / ₄ " (705)	1571	1622	TRGUDLAT30								



Trig Under Desk Pedestal Support Storage

Depth	Dimension		List Price Thermofused Grade		Catalog Number	Pull Style	Unit Color	Top Color	Top Edge Color	Drawer Color	Leg Trim Color	Lock Type	Lock Option
	Width	Height	1	2									
20" (508)	15 ¹ / ₂ " (394)	27 ³ / ₄ " (705)	\$1170	\$1200	TRGUDPED20	AZ Designer							
24" (610)	15 ¹ / ₂ " (394)	27 ³ / ₄ " (705)	1261	1291	TRGUDPED24								
30" (762)	15 ¹ / ₂ " (394)	27 ³ / ₄ " (705)	1321	1371	TRGUDPED30								



Build your complete Part Number here:

---	---	---	---	---	---	---	---	---	---	---	---	---	---
-----	-----	-----	-----	-----	-----	-----	-----	-----	-----	-----	-----	-----	-----

Sample Part Number:

TRGUDLAT20	.MD	.XZ2	.XZ2	.XZ2	.XZ4	.K	.TRG	.R
------------	-----	------	------	------	------	----	------	----

Total Cost \$1443 =

\$1412	+	N/C	+	N/C	+	N/C	+	N/C	+	N/C	+	\$31	+	N/C
--------	---	-----	---	-----	---	-----	---	-----	---	-----	---	------	---	-----

Under Desk Double-Door Support Storage

Trig Under Desk Double-Door Support Storage is pre-drilled to accept a 1" riser (included) for mounting under the desk (mounting screws included).

Features included hinged doors with optional locking. (Locking not available with aluminum doors) Units come with one shelf that adjusts vertically in 2 1/2" increments. Leveling glides are included in 2" support legs. Units are intended for under work surface support applications.

Ships fully assembled except 2" support leg.

Note: Trim color includes support legs and Framed Door option (FD) when selected.

Trig Under Desk Double-Door Support Storage

Depth	Dimensions		List Price Thermofused Grade		Catalog Number	Door Style	Framed Door Insert	Pull Style	Unit Color	Top Color	Top Edge Color	Door Color	Trim Color	Lock Type	Lock Option
	Width	Height	1	2											
20" (508)	30" (762)	27 ^{3/4} " (705)	\$ 1316	\$ 1367	TRGUDDD20	LD	Plexi-glass (01-02)	No Cost Applied	Thermo-fused Laminate	Thermo-fused Laminate	Thermo-fused Laminate	Thermo-fused Laminate	Standard Finish No Cost	NL No Cost No Lock	R No Cost Trig Random
24" (610)	30" (762)	27 ^{3/4} " (705)	1394	1465	TRGUDDD24	Cost Laminate Door		L Classic	(See Surface Materials Page 10)	(See Surface Materials Page 10)	(See Surface Materials Page 10)	Door Edge will match door color	Premium Finish +\$13	TRG +\$31 Trig Lock	T \$-15 Trig Key Alike
30" (762)	30" (762)	27 ^{3/4} " (705)	1453	1523	TRGUDDD30	FD + \$787 Framed Door	Frosted Plexi-glass (E3A) +\$130	E Stream-line				Specify only if LD selected	(See Surface Materials Page 10)	Note: Be sure to order core/key sets (TLCK) separately.	
Build your complete Part Number here:						_____	_____	_____	_____	_____	_____	_____	_____	_____	_____

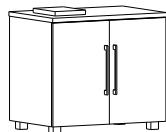

Sample Part Number:

TRGUDDD20	.LD	N/A	.MD	.XZ2	.XZ2	.XZ2	.XZ2	.K	.TRG	.R
-----------	-----	-----	-----	------	------	------	------	----	------	----

Total Cost \$1347 =

\$1316	+	N/C	+	N/C	+	N/C	+	N/C	+	N/C	+	N/C	+	N/C	+	\$31	+	N/C
--------	---	-----	---	-----	---	-----	---	-----	---	-----	---	-----	---	-----	---	------	---	-----

Trig Stack Storage - Open Shelf

Open Shelves can be used where open shelf storage is desired above any Trig credenza or freestanding storage 30" or wider. The stackers are available in two different heights to align with 53 3/4" and 65 3/4" high combination storage and storage towers. Standard features include a 3/8" (10) cord pass-through gap behind the shelves and a 1" full length cord management gap at the base of the back panel. An optional gap guard is available. The 27" high stacker has one adjustable shelf and the 39" has two adjustable shelves. Shelves are 5/8" thick and adjust in 2 1/2" increments.

Stackers ship ready to assemble with all necessary mounting hardware.

Trig Stack Storage - Paper Management Shelf

The Paper Management Shelf can be used above any Trig Credenza, Bench Height or Freestanding storage unit 30" or wider.

The Paper Management Shelf width does not need to match the width of the storage unit it stacks on. A narrower shelf can be placed anywhere along the width of the storage unit where paper management or open cubby storage is desired.

The 30" (762) & 45" (1143) wide shelf has a single opening and 60" (1524) & 75" (1905) have two openings with a center divider.

The Shelf ships ready to assemble.

Stack Storage – Open Shelf



Depth	Dimensions		List Price Thermofused Grade		Catalog Number	Unit/ Shelf Color	Top Color	Top Edge Color	Gap Guard
	Width	Height	1	2					
14" (356)	30" (914)	27" (686)	\$577	\$607	TRGSOS3027	Thermo-fused Laminate (See Surface Materials Page 10)	Thermo-fused Laminate (See Surface Materials Page 10)	Thermo-fused Laminate (See Surface Materials Page 10)	XN No Cost No Gap Guard XG + \$55 Gap Guard
		39" (991)	721	772	TRGSOS3039				

Stack Storage – Paper Management Shelf

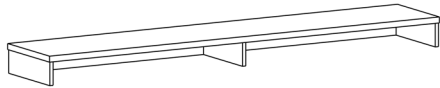

Depth	Dimensions		List Price Thermofused Grade		Catalog Number
	Width	Height	1	2	
14" (356)	30" (914)	5" (127)	\$253	\$268	TRGSPMS30
		45" (1143)	311	326	TRGSPMS45
		60" (1524)	433	448	TRGSPMS60
		75" (1905)	563	592	TRGSPMS75

Build your complete Part Number here:

-----	--	--	--	--
-------	----	----	----	----

Sample Part Number:

TRGSOS3027	.XZ1	.XZ2	.XZ4	.XN
------------	------	------	------	-----

Total Cost \$577 =

\$577	+	N/C	+	N/C	+	N/C	+	N/C
-------	---	-----	---	-----	---	-----	---	-----

Trig Overhead - Single Sliding Door

The Single Sliding Door Overhead is constructed of thermofused laminate with vinyl edgeband.

Overheads are for use above any Trig work surface that uses either legs or under desk storage as supports. Overheads cannot be used with work surfaces supported by Trig Combination Storage Towers.

The thermofused laminate door travels in an aluminum track by means of a pull. Each unit has a center divider, so there is always one cubby open and one closed. The unit does not lock. For A4 (11 7/16" x 12 5/8") sized binder storage, please reference the Overhead – Open Shelf or Hinged Door units.

Overheads are supported by steel legs, which can be specified in any Trendway Standard or Premium Systems Trim colors. Two leg height options are available to align the Overhead with either the 53 3/4" (1365) or 65 3/4" (1670) Trig Storage Tower when mounted on top of a Trig work surface.

Trig Overhead – Dual Sliding Doors

The Dual Sliding Door Overhead is constructed of thermofused laminate with vinyl edgeband.

The two frosted plexiglass doors have pulls and run back to back in an aluminum track. The unit does not lock. For A4 (11 7/16" x 12 5/8") sized binder storage, please reference

the Overhead – Open Shelf or Hinged Door units.

Overheads are for use above any Trig work surface that uses either legs or under desk storage as supports. Overheads cannot be used with work surfaces supported by Trig Combination Storage Towers.

Overheads are supported by steel legs, which can be specified in any Trendway Standard or Premium Systems Trim color. Two leg height options are available to align the Overhead with either the 53 3/4" (1365) or 65 3/4" (1670) Trig Storage Towers when mounted on top of a Trig work surface.

Trig Overhead - Single Sliding Door

Depth	Width	Height (without Legs)	List Price Thermofused Grade		Catalog Number	Pull Style	Support Option	Unit/ Shelf Color	Top Color	Top Edge Color	Door Color	Door Grain Direction	Trim Color
			1	2									
14" (356)	48" (1219)	15 1/2" (394)	\$ 1156	\$ 1206	TRGOSS48	No Cost Applied L Classic E Stream-line AZ Designer MM Mod2	54L + \$426 Legs to align with 54" high towers 66L + \$458 Legs to align with 66" high towers	Thermo-Fused Laminate (See Surface Materials Page 10)	Thermo-Fused Laminate (See Surface Materials Page 10)	Thermo-Fused Laminate (See Surface Materials Page 10)	Thermo-Fused Laminate (See Surface Materials Page 10)	NA No Grain Direction DGH Horizontal Grain DGV Vertical Grain	Standard Finish No Cost Premium Finish + \$19 (See Surface Materials Page 10)
	54" (1372)	1262	1313	TRGOSS54									
	60" (1524)	1314	1365	TRGOSS60									
	66" (1676)	1428	1479	TRGOSS66									
			1472	1523	TRGOSS72								

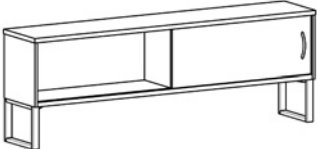

Trig Overhead - Dual Sliding Door

Depth	Width	Height (without Legs)	List Price Thermofused Grade		Catalog Number
			1	2	
14" (356)	48" (1219)	15 1/2" (394)	\$1472	\$1502	TRGODS48
	54" (1372)	1586	1636	TRGODS54	
	60" (1524)	1689	1740	TRGODS60	
	66" (1676)	1819	1870	TRGODS66	
	72" (1829)	1890	1941	TRGODS72	

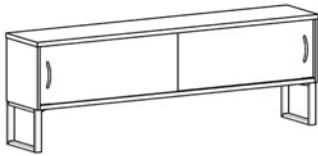

Build your complete Part Number here:

---	---	---	---	---	---	---	---	---	---
-----	-----	-----	-----	-----	-----	-----	-----	-----	-----

Sample Part Number:

TRGOSS48	.MM	.54L	.ZX2	.XZ2	.XZ2	.XZ4	.DGV	.PA
---	---	---	---	---	---	---	---	---

Total Cost \$1582 =

\$1156	+	N/C	+	\$426	+	N/C	+	N/C	+	N/C	+	N/C	+	N/C	+	N/C	+	N/C
--------	---	-----	---	-------	---	-----	---	-----	---	-----	---	-----	---	-----	---	-----	---	-----

Trig Overhead – Hinged Doors

The Hinged Door Overhead is constructed of thermofused laminate with vinyl edgeband.

Each unit includes 2 pairs of locking hinged doors. The same door size is used for all units. Overheads that are 66" (1676) and wider will have a center open cubby, which increases in width proportionately with the width of the overall unit. The Overhead can accommodate standard and A4 (11 7/16" x 12 5/8") sized binders.

If a wood grain laminate is selected the grain will run vertically on the door front.

Overheads are for use above any Trig work surface that uses either legs or under desk storage as supports. Overheads cannot be used with work surfaces supported by Trig Combination Storage Towers.

Overheads are supported by steel legs, which can be specified in any Trendway Standard or Premium Systems Trim color. Two leg height options are available that will align the Overhead with either the 53 3/4" (1365) or 65 3/4" (1670) Trig Storage Towers when mounted on top of Trig work surfaces.

Center Cubby Size Per Overhead

Unit Width	Center Cubby Width
66" (1676)	6" (152)
72" (1829)	12" (305)
78" (1981)	18" (457)
84" (2134)	24" (610)

Trig Overhead - Hinged Door

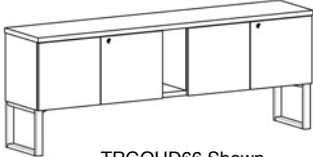
Depth	Width	Height (without Legs)	List Price Thermofused Grade		Catalog Number	Support Option	Unit/ Shelf Color	Top Color	Top Edge Color	Door Color	Leg Trim Color	Lock Type	Lock Option
			1	2									
14" (356)	60" (1524)	15 1/2" (394)	\$1032	\$1083	TRGOHD60	54L + \$426 Legs to align with 54" high towers	Thermo-Fused Laminate (See Surface Materials Page 10)	Thermo-Fused Laminate	Thermo-Fused Laminate	Thermo-Fused Laminate	Standard Finish No Cost	NL No Cost No Lock	R No Cost Trig Random
	66" (1676)		1111	1181	TRGOHD66								
	72" (1829)		1139	1210	TRGOHD72								
	78" (1981)		1240	1311	TRGOHD78								
	84" (2134)		1269	1339	TRGOHD84								
					66L + \$458 Legs to align with 66" high towers					Premium Finish +\$19	TRG +\$66 Trig Lock	T -\$30 Trig Key-Alike	
 <p>TRGOHD66 Shown</p>													
Build your complete Part Number here:			-----	-----	-----	-----	-----	-----	-----	-----	-----	-----	-----

Sample Part Number:

<u>TRGOHD60</u>	<u>.54L</u>	<u>.XZ2</u>	<u>.XZ2</u>	<u>.XZ2</u>	<u>.XZ4</u>	<u>.K</u>	<u>.NL</u>	<u>N/A</u>
-----------------	-------------	-------------	-------------	-------------	-------------	-----------	------------	------------

Total Cost \$1458 =

\$1032	+	\$426	+	N/C	+	N/C	+	N/C	+	N/C	+	N/C	+	N/C
--------	---	-------	---	-----	---	-----	---	-----	---	-----	---	-----	---	-----

Trig Overhead - Open Shelf

The Open Shelf Overhead is constructed of thermofused laminate with vinyl edgeband.

Overheads are for use above any Trig work surface that uses either legs or under desk storage as supports. Overheads cannot be used with work surfaces supported by Trig Combination Storage Towers. The Overhead can accommodate standard and A4 (11 7/16" x 12 5/8") sized binders.

Open Shelf Overheads are supported by steel legs, which can be specified in any Trendway Standard or Premium Systems Trim colors. Two leg height options are available to align the Overhead with either the 53 3/4" (1365) or 65 3/4" (1670) Trig Storage Tower when mounted on top of a Trig work surface.

Trig Overhead - Open Shelf

Depth	Width	Height (without Legs)	List Price Thermofused Grade		Catalog Number	Support Option	Unit/ Shelf Color	Top Color	Top Edge Color	Leg Trim Color
			1	2						
14" (356)	48" (1219)	15 1/2" (394)	\$446	\$476	TRGOOS48	54L + \$426 Legs to align with 54" high towers	Thermo-fused Laminate (See Surface Materials Page 10)	Thermo-fused Laminate (See Surface Materials Page 10)	Thermo-fused Laminate (See Surface Materials Page 10)	Standard Finish No Cost Premium Finish + \$19 (See Surface Materials Page 10)
	54" (1372)		542	592	TRGOOS54					
	60" (1524)		691	742	TRGOOS60					
	66" (1676)		837	887	TRGOOS66					
	72" (1829)		894	944	TRGOOS72					
	78" (1981)		980	1050	TRGOOS78					
84" (2134)	1008	1079	TRGOOS84	66L + \$458 Legs to align with 66" high towers						
Build your complete Part Number here:						---	---	---	---	---

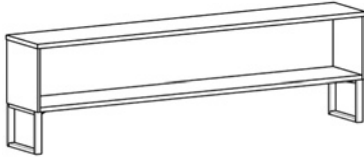

Sample Part Number:

TRGOOS48	.54L	.XZ2	.XZ4	.XZ4	.DW
----------	------	------	------	------	-----

Total Cost \$872 =

\$446	+	\$426	+	N/C	+	N/C	+	N/C	+	N/C
-------	---	-------	---	-----	---	-----	---	-----	---	-----

Trig Storage to Panel Brackets

Storage to Panel Brackets are used to connect Trig Storage units to Capture or Choices system panels for additional workstation rigidity. Brackets are designed to provide stability to layouts that would otherwise require return panels.

For detailed application information regarding use of the Storage to Panel Bracket, refer to the *Trig Desking Planning Guide*.

Storage to Panel Brackets are available in Charcoal only.

All necessary hardware for assembling brackets to Trig storage is included.

Trig Support Leg to Panel Brackets

The Leg to Panel Bracket is used to connect Trig Support Legs to Capture or Choices system panels for additional workstation rigidity. Brackets are designed to provide stability to configurations that would otherwise require return panels.

Two different brackets are available for use with either Capture or Choices. Their specific use depends on the orientation of the work surface relative to the panel.

Capture

TRGLCPTPB1 – Used when a work surface is parallel to a Capture panel

TRGLCPTPB2 – Used when a work surface is perpendicular to a Capture panel

TRGLCPTPB3 – Used when two work surface are parallel to a Capture panel, with a side to side shared leg between them

Choices

TRGLCSPB1 – Used when a work surface is parallel to a Choices panel

TRGLCSPB2 – Used when a work surface is perpendicular to a Choices panel

TRGLCSPB3 – Used when two work surface are parallel to a Choices panel, with a side to side shared leg between them

them

For detailed application information regarding use of the Support Leg to Panel Bracket, refer to the *Trig Desking Planning Guide*.

Support Leg to Panel Brackets are available in all Standard and Premium Systems Trim Finishes.

All necessary hardware for assembling brackets to Trig Support Legs is included.



Trig Storage to Panel Brackets

Description	List Price	Catalog Number
Storage to Capture Panel	\$157	TRGSCPTPB
Storage to Choices Panel	144	TRGSCSPB
Build your complete Part Number here:		-----



Trig Support Leg to Panel Brackets

Description	Usage	List Price	Catalog Number	Trim Color	
Support Leg to Capture Panel	Parallel	\$160	TRGLCPTPB1	Standard Finish No Cost	
	Perpendicular	160	TRGLCPTPB2		
Support Leg to Choices Panel	Parallel	146	TRGLCSPB1		Premium Finish + \$5
	Perpendicular	146	TRGLCSPB2		
Side to Side Support Leg to Capture Panel	Parallel	\$160	TRGLCPTPB3	(See Surface Materials Page 10)	
Side to Side Support Leg to Choices Panel	Parallel	\$146	TRGLCSPB3		
Build your complete Part Number here:			-----	-	

Sample Part Number:

TRGLCSPB1	.Y
-----------	----

Total Cost \$146 =

\$146	+	N/C
-------	---	-----

Trig Benching Electrical

Benching Electrical Components 80

Benching Electrical Accessories 83

Components

Trig Power Raceway

The Trig Power Raceway consists of four parts - Raceway to Table Connector, Trig Raceway Shroud, Power Block Brackets, and the Power Block.

The Bracket and Blocks ship attached to the Raceway to Table Connector. The Raceway to Table Connector attaches to the underside of the desk. Once installed, the Shroud attaches to it to form a complete raceway. The width of the Raceway is actual. Please refer to the chart below to specify the correct width Raceway for each desk configuration.

The Trig Power Raceway is designed to work in a double sided application. It will be placed across the seam on the underside of two Trig Tops. If a single sided option is needed, please contact Trendway Customer Care for specifics.

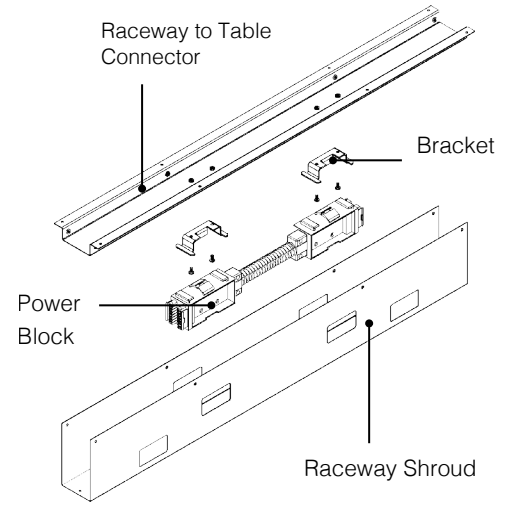

Specifying Raceway Widths

The support on both sides of the Trig Desk will play a part in the Raceway width needed. This chart shows how much room the support takes up. Add up the supports on both sides of the desk and subtract from the overall width of the desk.

Leg	6"
Ped	18"
Riser	18"
Under Desk Storage	36"

Support 1	Support 2	Surface Width	Surface Width								
			36	42	48	54	60	66	72	78	84
		Minus	Raceway Width								
Leg (6)	Leg (6)	12	24	30	36	42	48	54	60	N/A	N/A
Leg (6)	Bench Hgt Riser(18)	24			24	30	36	42	48	54	60
Leg (6)	Ped (18)*	24			24	30	36	42	48	54	60
Leg (6)	UD Support (30)*	42						24	30	36	42

* In order for a Raceway to span the full width, the depth of any Under Desk support used must be 4" shorter on a 24" deep surface, and 6" shorter on a 30" deep surface to allow sufficient clearance.

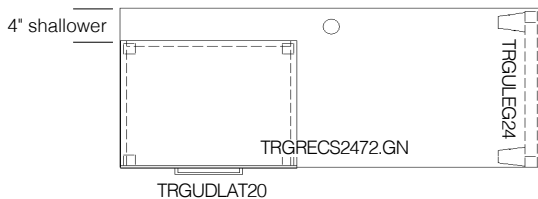
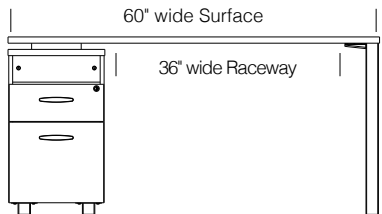
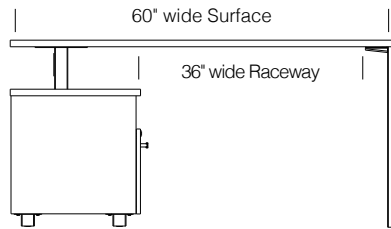
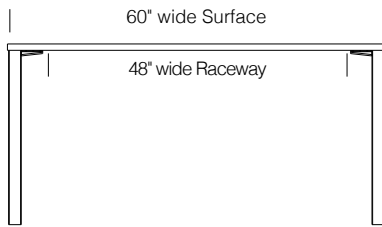

Trig Power Raceway Spanning Cover

The Trig Power Raceway Spanning Cover is used to enclose power and data cables when they span across to an adjacent Table's Raceway. There are three versions of the Cover to accommodate most configurations.

The TRGPRSC12SL is specified when a single U Leg is shared in the center of four adjacent Tops. There is a single notch opening to accommodate the U Leg.

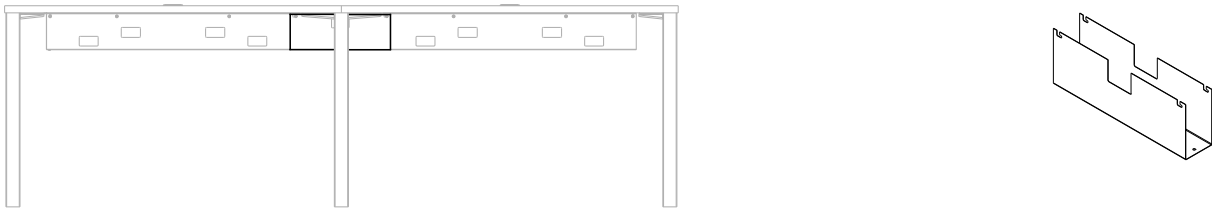

The TRGPRSC12DL is specified when two U Legs are shared legs in the center of four adjacent Tops. There is a single notch opening large enough to accommodate two U Legs.

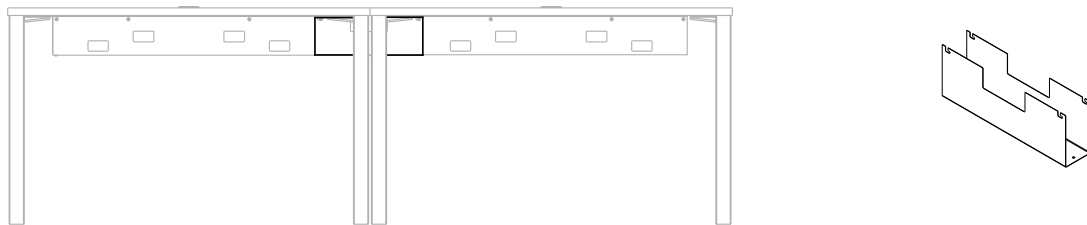

The TRGPRSC364R is specified when four risers are used, or a combination of four storage pieces that all must be at least 4" shorter than the depth of the Top. There is no opening. This version can be used to accommodate most configurations.

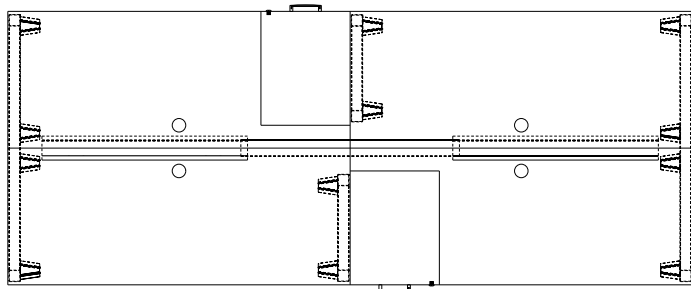
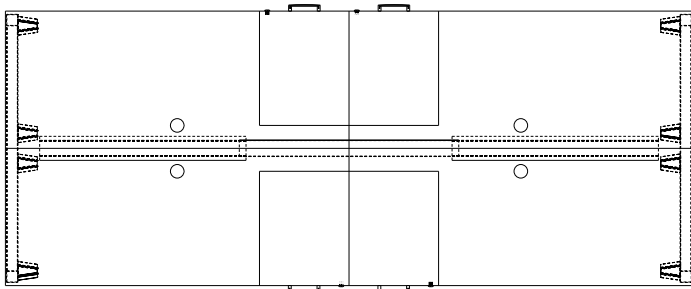
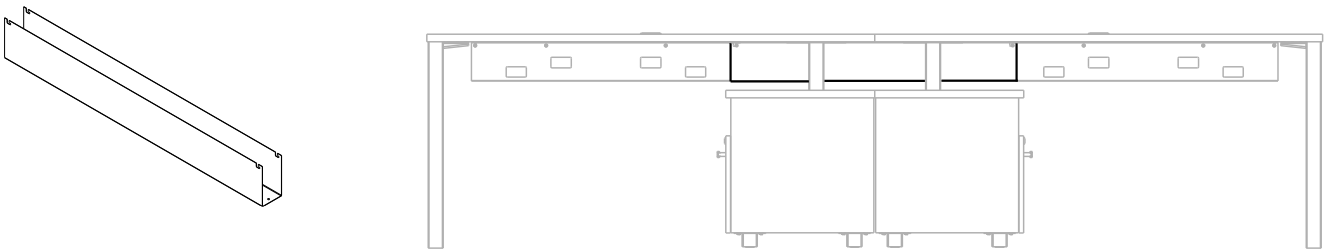

Power Block

Power Blocks ship complete with the Raceway.

- Power Blocks provide power access on both sides, accommodating up to two snap-in Power Duplexes per side.
- 24" (610) Raceways include only one Power Block, a single Distribution Block that accommodates up to two snap-in Power Duplexes (maximum one per side).
- 30" (762), 36" (914), 42" (1067), 48" (1219), 54" (1372) and 60" (1524) Raceways ship with two Distribution Blocks to accommodate up to four snap-in Power Duplexes (maximum two per side).

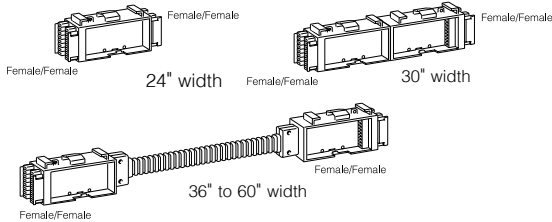

Trig Electrical Harness

Electrical Harnesses connect power horizontally from one adjacent Work Surface to another. The Harness attaches to a Block positioned 9" from the end of each Raceway, so when specifying the Harness length you will add 18" (9" + 9") to the distance between adjacent raceways. The type of Support used will determine the length of Harness required (see table below).



Leg	6"
Ped	18"
Riser	18"
Under Desk Storage	36"

In the figure below, connection A supports include a Ped and a Leg (18" + 6") + (18" for the distance inside the raceway), for a total of 42". For connection B, the supports consist of a Leg and a Leg (6" + 6") + (18" for the distance inside the raceway) for a total of 30".

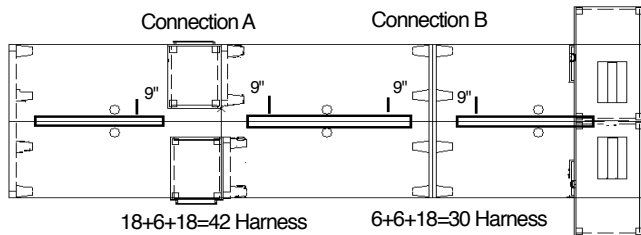

NOTE: A Harness cannot be used if a full depth storage piece is located next to a Leg. This configuration does not allow sufficient clearance for the Harness to extend to the next table.

NOTE: If no full depth under desk storage is present and full-depth U legs are positioned diagonally from each other on facing Work Surfaces, you must add 6" to the length of a Harness in order to pass around the U Legs.

Trig Power Infeed

Trig End Mount Infeed

The Trig End Mount Infeed installs into the end of a Power Block. It includes 6' (1829) of flexible liquid tight conduit for hardwiring the standard 4-Circuit Base Feed to the building's electrical system. It can be used on its own or housed by a Trig Floor Power Pole.

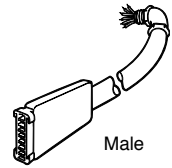

Trig Floor Power Pole

The Trig Floor Power Pole is used to channel electrical components and communication cables. It attaches to the side of a Trig U Leg.



Trig Ceiling Feed

The Trig Ceiling Feed supplies power from the ceiling to the Power Block. The Feed is housed by the Trig Ceiling Power Pole. It has 13' (3962) of wire and 12' (3658) of flexible conduit.

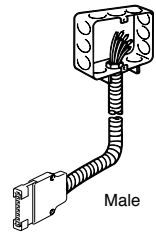

Trig Ceiling Power Pole

The Trig Ceiling Power Pole is used to house electrical components and communication cables accessed from the ceiling. It attaches to a Trig U Leg at the end of a run.

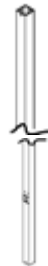

Trig Electrical Duplex

The Trig Electrical Duplex provides user access to power. It plugs into the Power Blocks that ship complete with the Raceway. There are nine different duplexes used to create three different 4-Circuit options (See Electrical Circuit Planning section). Each Duplex is color coded and marked to distinguish whether it is a general, dedicated or isolated circuit.

Circuits are marked with the following symbols: I, II, III, IV, I, II, III, III, IV. Duplexes must be specified separately to match the desired electrical circuit plan.

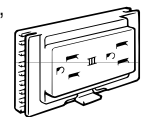

Communication Module

The Communication Module snaps into an open Duplex location in the Raceway to provide access to communication distribution.

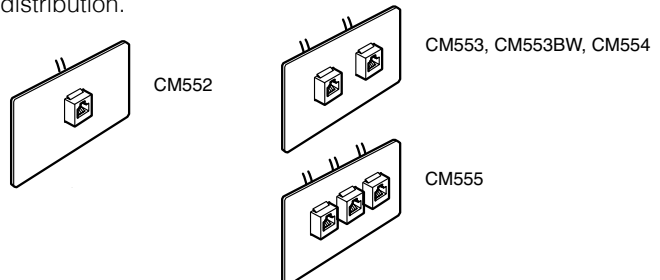

The 8-Wire Trig Electrical Circuit Planning and Hardwiring to Building Electrical Source

The Trig Electrical System is an 8-Wire, 4-Circuit system including a dedicated neutral and ground. Each circuit is rated for 20 amps. The PowerPac Electrical Schematic is included to show how the system installs to the building's power source (Fig. 1). There are three - four circuit options which include:

- Three general circuits, one dedicated circuit (Fig. 2).
- Three isolated circuits, one dedicated circuit (Fig. 3).
- Two general circuits, two isolated circuits (Fig. 4).

Fig. 1 Installing to Buildings Power Source
208/120V 3-Phase Building Supply

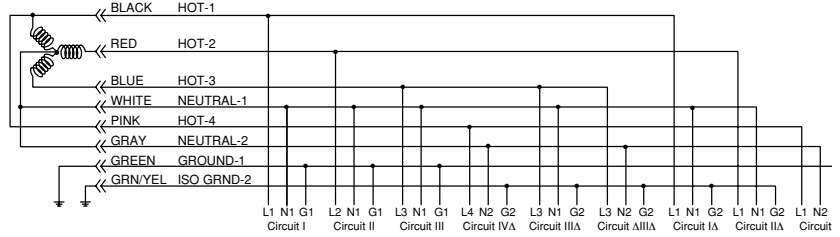

240/120V Single-Phase Building Supply

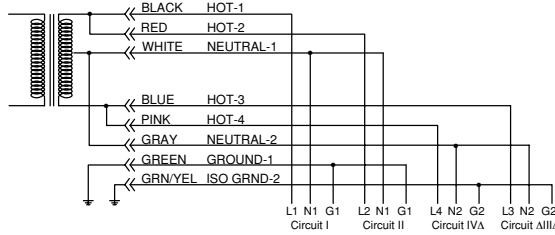

Options for PowerPac Four Circuit System

Fig. 2 Three General Circuits, One Dedicated

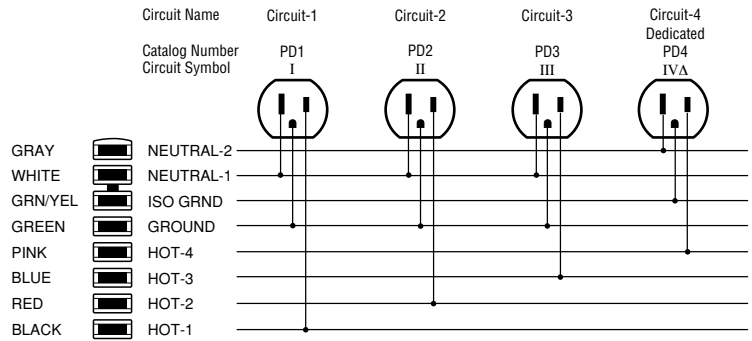

Fig. 3 Three Isolated Circuits, One Dedicated

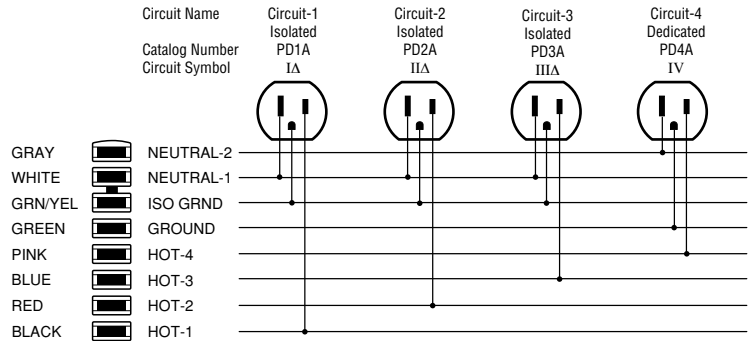
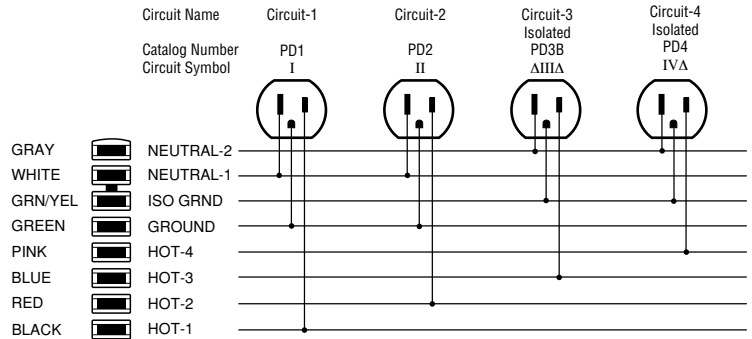

Fig. 4 Two General Circuits, Two Isolated



Trig Power Raceway

The Trig Power Raceway provides a steel enclosure that houses and routes power and data in Trig Benching applications. Each Raceway 30" and wider has four openings per side, two for power duplexes and two for data. The 24" Power Raceway has one power and two data openings per side. Raceways are specified to accommodate Trendway's standard 8 wire 4 circuit power system (P1) or a hardwire solution (H). The Power Raceway ships with an Electrical Block or 2 hardwire boxes included, and attachment brackets installed. Power

Duplexes, Harnesses and Infeeds must be specified separately.

The unit ships with all attachment hardware included. The Raceway is available in all Trendway Standard and Premium Finishes.

Trig Power Raceway End Cover

The Trig Power Raceway End Cover provides a finished appearance at the end of a Trig Power Raceway.

Not to be used on the same side as an Infeed.

The unit ships with all attachment hardware included. The End Cover is available in all Trendway Standard and Premium Finishes.

Trig Power Raceway Spanning Covers

The Trig Power Raceway Spanning Cover is used to conceal power and data cables where they span to an adjacent Raceway. The Cover attaches two Trig Power Raceways to create a continuous steel enclosure beneath the surfaces.

The Spanning Cover is available in all Trendway Standard and Premium Finishes.

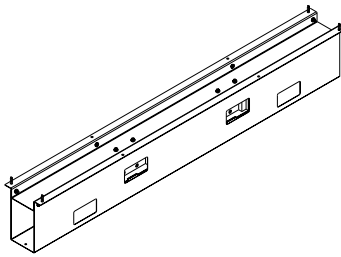

Trig Power Raceway

Width	Dimensions Depth	Height	List Price	Catalog Number	Power Option	Trim Color
24" (610)	2 3/4" (70)	5 1/4" (133)	\$361	TRGPR24	No Cost P1 8 Wire 4 Circuit	Standard Finish No Cost
30" (762)			409	TRGPR30		
36" (914)			460	TRGPR36		
42" (1067)			480	TRGPR42		
48" (1219)			508	TRGPR48	H Hardwired	Premium Finishes +\$36
54" (1372)			526	TRGPR54		
60" (1524)			569	TRGPR60		

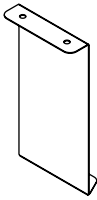

Trig Power Raceway End Cover

Width	Dimensions Height	List Price	Catalog Number	Trim Color
2 3/4" (70)	5 1/4" (133)	\$55	TRGPREC	Standard Finish No Cost Premium Finishes +\$6

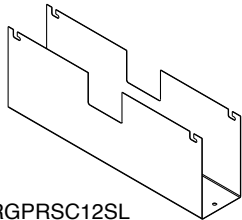

TRGPRSC12SL

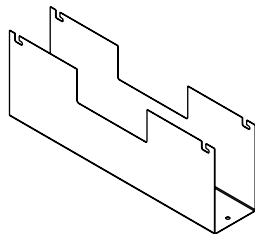

TRGPRSC12DL

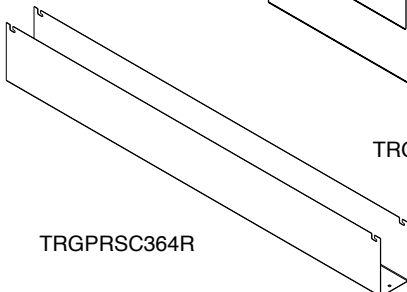

TRGPRSC364R

Trig Power Raceway Spanning Cover

Description	Dimensions Width	Height	List Price	Catalog Number	Trim Color
Single Shared Leg	14 1/4" (362)	5 1/4" (133)	\$128	TRGPRSC12SL	Standard Finish No Cost Premium Finishes +\$19
Double "Single sided" Legs	14 1/4" (362)	5 1/4" (133)	128	TRGPRSC12DL	
4 Bench Height Risers	38 1/4" (972)	5 1/4" (133)	159	TRGPRSC364R	

Build your complete Part Number here:

Sample Part Number:

TRGPR24	.P1	.G
---	---	---

Total Cost \$361 =

\$361	+	N/C	+	N/C
-------	---	-----	---	-----

Trig Ceiling Power Pole

The Trig Ceiling Power Pole encloses and routes power and communication cables from the ceiling to the Trig Power Raceway. The Power Pole is 12' in height and will attach structurally into the ceiling and to the Trig U Leg at the end of a run. Pole capacity is 50 1/4" diameter cables with a ceiling feed.

Note: To connect the Trig electrical system to ceiling power, order the CFTP power feed.

Trig Floor Power Pole

The Trig Floor Power Pole has a 2 inch by 2 inch profile that attaches seamlessly to the side of a Trig U Leg. The Power Pole has a removable 4th side that allows for easy access to power and communication cables. The Pole is 26" high and attaches on the inside quarter of the leg. The Pole capacity is 31 1/4" diameter cables without an infeed, and 23 1/4" diameter cables with an infeed.

Note: To connect the Trig electrical system to building power, order the EBFH Infeed.

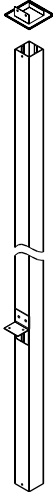

Trig Ceiling Power Pole

Width	Dimensions Depth	Height	List Price	Catalog Number	Trim Color
2 ⁵ / ₈ " (67)	2 ⁵ / ₈ " (67)	12' (3658)	\$418	TRGCPP144	Standard Finish No Cost Premium Finishes +\$38 See Surface Material Page 10



Trig Floor Power Pole

Width	Dimensions Depth	Height	List Price	Catalog Number	Trim Color
2" (51)	2" (51)	26 ⁵ / ₈ " (676)	\$143	TRGFPP27	Standard Finish No Cost Premium Finishes +\$19 See Surface Material Page 10

Build your complete Part Number here:

-----	--
-------	----

Sample Part Number:

TRGFPP27	. G
----------	-----

Total Cost \$143 =

\$143	+ N/C
-------	-------

Trig Ceiling Feed

The Ceiling Feed supplies power from the ceiling to the Trig Raceway. The feed is channeled through the Trig Ceiling Power Pole. The CFTP which has 13' (3692) of wire and 12' (3658) of flexible conduit when fully extended. The Ceiling Feed includes junction box and attachment hardware.

Trig End Mount Feed

The End Mount Base Feed plugs into a Power Block to feed power from the building's electrical system. It provides 6' (1829) of flexible liquid tight conduit for hardwiring the standard four-circuit system. UL and CUL Listed/CSA Certified.

Available in Black only.

Trig Benching Electrical Harness

Trig Electrical Harnesses connect Electrical Blocks, distributing power horizontally from one Trig unit to another. The Electrical Harness is UL Listed and CUL Listed/CSA Certified.

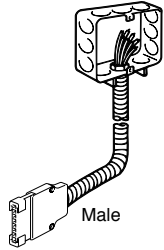

Trig Ceiling Feed

Wire Length	Conduit Length	List Price	Catalog Number
15' (67)	14" (4267)	\$190	CFTP144

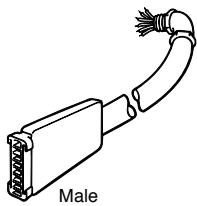

Trig End Mount Feed

Cord Length	List Price	Catalog Number
6' (1829)	\$209	EBFH

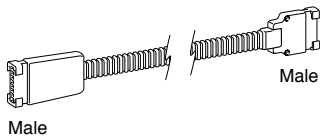

Trig Benching Electrical Harness

Length	List Price	Catalog Number
30" (762)	\$114	TRGPBH30
42" (762)	124	TRGPBH42
48" (762)	134	TRGPBH48
54" (762)	139	TRGPBH54
60" (762)	148	TRGPBH60
66" (762)	152	TRGPBH66
72" (762)	156	TRGPBH72
78" (762)	160	TRGPBH78
90" (762)	162	TRGPBH90

Build your complete Part Number here:

Sample Part Number:

CFTP144

Total Cost \$190 =

\$190

Trig Power Duplexes

The Power Duplex plugs into Electrical Blocks for access to the circuit. Power Duplex is clearly marked for Circuit I, II, III, IV, IΔ, IIΔ, IIIΔ, ΔIIIΔ or IV access. See Power Electrical Components and Electrical Circuit Planning for guidelines on specifying Electrical Duplexes. Packaged in boxes of six of the same duplex. UL and CUL Listed/CSA Certified.

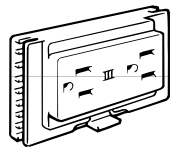

Communication Modules

The Communication Module snaps into an open duplex location in the baseline and at the beltway. It provides access to communication cables. Jacks are color coded as noted below. Includes icon tabs for easy identification of Data, Phone, Voice, and LAN (Local Area Network) lines.

Note: Verify your configuration with your building telecommunication contractor.

Note: All modules can be installed back to back.

Note: The RJ11 Jacks are rated category 3. The RJ45 Jacks are rated category 5e.

Trig Power Duplexes

Description	List Price	Catalog Number	Trim Color
15 AMP Recepticals			
Circuit I Box of 6	\$ 169	TRGPD151	Standard Finish No Cost See Surface Material Page 10
Circuit II Box of 6	169	TRGPD152	
Circuit III Box of 6	169	TRGPD153	
Circuit IVΔ Box of 6	190	TRGPD154	
Circuit IΔ Box of 6	\$ 204	TRGPD151A	
Circuit IIΔ Box of 6	204	TRGPD152A	
Circuit IIIΔ Box of 6	204	TRGPD153A	
Circuit ΔIIIΔ Box of 6	204	TRGPD153B	
Circuit IV Box of 6	204	TRGPD154A	

Communication Modules

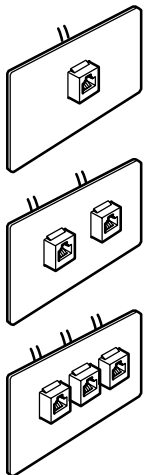

CM552

CM553, CM553BW, CM554

CM555

Description	List Price	Catalog Number
One RJ45, Cat. 5e, 110 Terminal, Black Jacks, Black Faceplate	\$ 90	CM552
Two RJ45, Cat. 5e, 110 Terminal, Black Jacks, Black Faceplate	123	CM553
Two RJ45, Cat. 5e, 110 Terminal, One Blue Jack, One White Jack, Black Faceplate	123	CM553BW
One RJ11, Cat. 3, One RJ45, Cat. 5e, 110 Terminal	123	CM554
Three RJ45, Cat. 5e, 110 Terminal, One Black Jack, One Blue Jack, One White Jack, Black Faceplate	156	CM555
Four RJ45, Cat. 6, One Black Jack, One White Jack, One Green Jack, One Gray Jack	347	CM6666

Note: Communication Modules require an open duplex location.

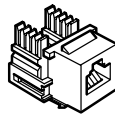

110 Terminal

Build your complete Part Number here: _____

Sample Part Number:

TRGPD151

Total Cost \$169 =

\$169

Trig Power Grommet

The Trig Power Grommet includes the Grommet and a 6' cord to plug into an adjacent standard 15 amp outlet. Grommets can be specified with two power outlets, one power outlet and one USB port, or one power outlet and one open data port. **The Power Grommet fits a factory cut opening on Trig tops with the PNDR or PNDL option selected.** It can also be purchased separately and field installed where desired. Available in Black or White.

Note: A power grommet cannot be installed in a worksurface with a 26.75" high storage unit below.

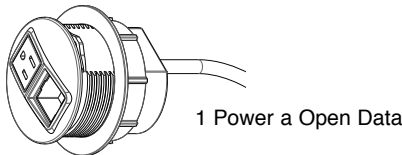
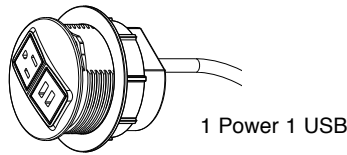
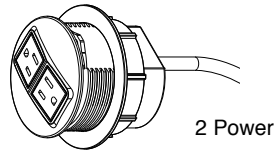

Trig Power Grommets

Description	List Price	Catalog Number
White Unit Color		
2 Power	\$ 269	TRGPND2PW
1 Power 1 USB	379	TRGPND1P1UW
1 Power a Open Data	269	TRGPND1P1DW
Black Unit Color		
2 Power	\$ 269	TRGPND2PB
1 Power 1 USB	379	TRGPND1P1UB
1 Power a Open Data	269	TRGPND1P1DB
Build your complete Part Number here:		-----

Sample Part Number:

TRGPND2PW

Total Cost \$269 =

\$269

Trig Electrical

Electrical Specification Guide 90

Electrical Components 91

Electrical Accessories 93

Trig Electrical Planning Guide

Trig Workstations can be powered by the optional 4-wire, 2-circuit, 20 Amps each (circuit 1 and 2 only) electrical system. The systems supports up to 10 receptacles per circuit, 20 receptacles per Base Feed. Allowing for a total of 10 Power Sets per Base Feed.

The main system components are Power Sets, Electrical Harnesses, H-Connectors and Power Base Feeds. All components are UL listed.

All work surfaces are predrilled to accept Power Sets. These are attached to the underside of the surface by a metal spring clip. The overall height of the system is just over an inch. This provides a very low profile which will not interfere with the user's legs under the table.

There is currently no capacity in this system for data management.

Electrical Harness Selection

Trig Electrical Harnesses are used to connect Power Sets mounted on different work surfaces. The length of the harness needed will depend on the layout and size of work surfaces used. The following diagrams and tables will help identify the specific length harness needed for a particular layout.

Side By Side

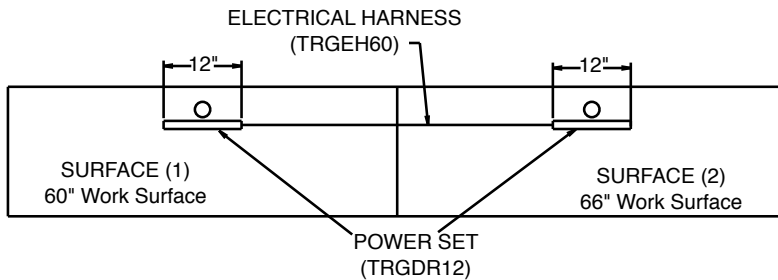

For this layout, the harness length is calculated by the following equation:

$$(\text{Half of Surface 1 width}) + (\text{Half of Surface 2 width}) - 6" = \text{Harness Length}$$

If calculated harness length does not match an exact size, select next longer length.

Example: Surface (1) is 60" wide
Surface (2) is 66" wide

$$(30") + (33") - 6" = 57" \text{ (57" is not a standard size so a 60" length is selected)}$$

Back to Back (Surfaces of Equal Width)

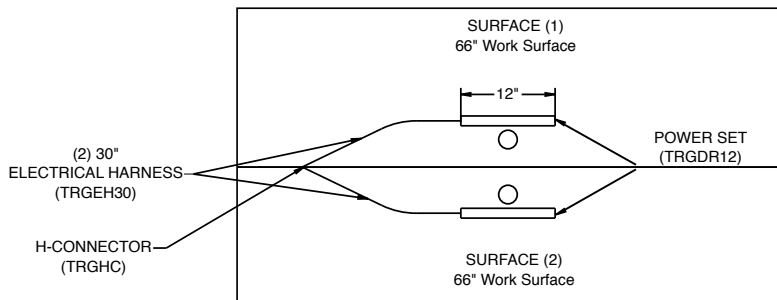

In this layout, the power Base Feed connects to the H-Connector. From there, the power is split to the Electrical Harness to bring power to each surface.

The chart below shows the needed harness length for each width of work surface. (A separate harness will need to be ordered for each surface)

Work Surface Width	48"	54"	60"	66"	72"	78"	84"
Harness Length	18"	24"	24"	30"	30"	36"	36"

COMBINING LAYOUTS Side by Side and Back to Back

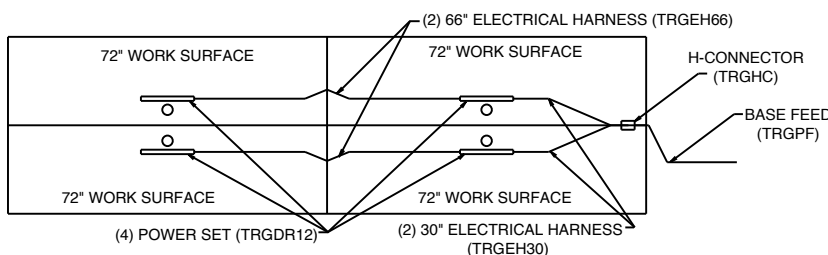

In this layout, both side-by-side and back-to-back planning information is needed to specify the correct electrical components. The harness length required to connect the work surfaces side-by-side is determined by using this equation:

$$(\text{Half of Surface 1 width}) + (\text{Half of Surface 2 width}) - 6" = \text{Harness Length}$$

To connect these work surfaces back-to-back, refer to the corresponding chart above.

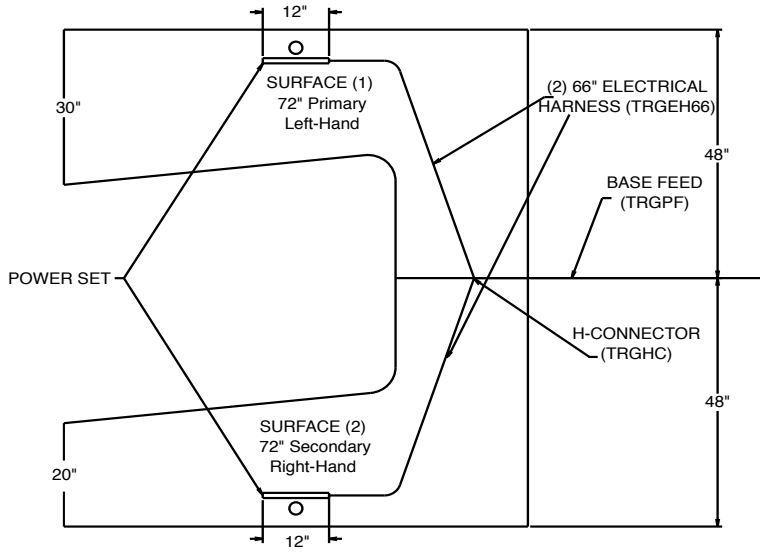

In this U-Shape layout where only 48" deep ends can be used, the power Base Feed will connect to the H-Connector and the power is split to go to each surface. The chart below shows the needed harness length for each width of work surface. (A separate harness will need to be ordered for each surface)

Work Surface Width	54"	60"	66"	72"	78"	84"
Harness Length	60"	60"	66"	66"	66"	66"

L-Shape (Except Blade)

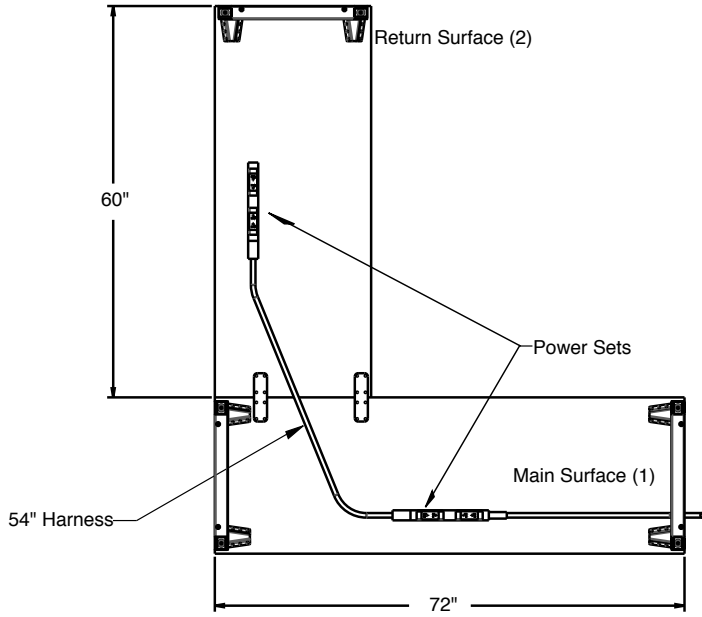

For this layout, the needed harness length will vary as the width and depth of the work surfaces change. The Trig Base Feed will end mount to Power Sets on one of the tables, but the harness length that connects the two work surfaces is determined from the following tables:

Layout 1

Main Surface (1) = 20" deep
Return Surface (2) = 20", 24" or 30" deep

Return Surface (2) width (maximum size is 72" with under desk)

	54"	60"	66"	66"	72"
48"	48"	48"	54"	54"	60"
54"	48"	48"	54"	54"	60"
60"	48"	48"	54"	54"	60"
66"	48"	54"	54"	54"	60"
72"	48"	54"	54"	60"	60"
78"	54"	54"	54"	60"	60"
84"	54"	54"	60"	60"	66"

Layout 2

Main Surface (1) = 24" deep
Return Surface (2) = 20", 24" or 30" deep

Return Surface (2) width (maximum size is 72" with under desk)

	48"	54"	60"	66"	72"
48"	48"	48"	54"	54"	60"
54"	48"	48"	54"	54"	60"
60"	48"	48"	54"	54"	60"
66"	54"	54"	54"	54"	60"
72"	54"	54"	54"	60"	66"
78"	54"	60"	60"	60"	66"
84"	54"	60"	60"	60"	66"

Layout 3

Main Surface (1) = 30" deep
Return Surface (2) = 20", 24" or 30" deep

Return Surface (2) width (maximum size is 72" with under desk)

	48"	54"	60"	66"	72"
48"	54"	60"	60"	66"	66"
54"	54"	60"	60"	66"	66"
60"	54"	60"	60"	66"	66"
66"	60"	60"	66"	66"	66"
72"	60"	60"	66"	66"	72"
78"	60"	66"	66"	66"	72"
84"	60"	66"	66"	72"	72"

Power Set

The Trig Power Sets allow power to be connected between work surfaces without the need for a system panel. Each Power Set includes two receptacles for a total of 4 outlets. Each outlet has one receptacle for circuit 1 and one for circuit 2.

Power Sets are centrally located on the work surfaces. Spring clips for mounting are included. Power Sets are connected between work surfaces with Trig Electrical Harnesses. Trig Base Feed brings power to the Power Sets.

Note: Work surfaces are predrilled for Trig Power Set mounting to assure a standard location that is centrally located.

UL and CUL Listed/CSA Certified

Trig Base Feed

The Trig Base Feed conducts power from the building to the Trig Power Set. It includes 6' (1829) of flexible liquid-tight conduit for hard-wiring the standard two-circuit system to the building power supply.

Trig Base Feed is also used with a Trig H-Connector in cases where a single power feed needs to be split in two directions. Trig Electrical Harnesses are used to link the H-Connector to the Power Sets in this type of configuration.

Electrical Harnesses

Trig Electrical Harnesses connect Trig Power Sets between two surfaces. Harnesses are also used with Trig H-Connectors when a single Base Feed is split in two directions. The specific length of the harness needed will depend on the layout and work surface sizes. Refer to Trig Electrical Planning guide before specifying a harness length. (If your specific layout is not shown, please contact Trendway Customer Care for assistance.)

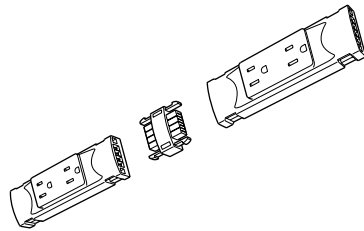

Trig Power Set

Width	List Price	Catalog Number
12" (305)	\$173	TRGDR12

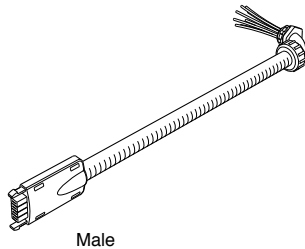

Trig Base Feed

Width	List Price	Catalog Number
6' (1829)	\$136	TRGPF
12' (3658)	\$205	TRGPF12

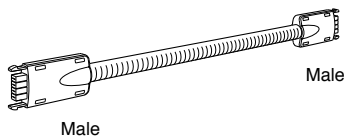

Trig Electrical Harness

Width	List Price	Catalog Number
18" (457)	\$75	TRGEH18
24" (610)	78	TRGEH24
30" (762)	82	TRGEH30
36" (914)	86	TRGEH36
42" (1067)	93	TRGEH42
48" (1219)	101	TRGEH48
54" (1372)	107	TRGEH54
60" (1524)	112	TRGEH60
66" (1676)	117	TRGEH66
72" (1829)	124	TRGEH72
78" (1981)	130	TRGEH78

Build your complete Part Number here: _____

Sample Part Number:

TRGDR12

Total Cost \$173 =

\$173

New York Base Feed

The Trig New York Base Feed conducts power from the building to the Trig Power Set. It includes 18" (457) of flexible liquid-tight conduit for hard-wiring the standard two-circuit system to the building power supply.

Trig New York Base Feed is also used with a Trig H-Connector in cases where a single power feed needs to be split in two directions. Trig Electrical Harnesses are used to link the H-Connector to the Power Sets in this type of configuration.

H-Connector

The Trig H-Connector allows power to be routed in up to 3 different directions. This is useful in layouts that require a single Base Feed to reach multiple work surfaces.

(See Planning Guide for Specific Uses.)



Trig Base Feed New York

Width	List Price	Catalog Number
18" (457)	\$129	TRGPFNY

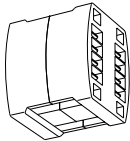

Trig H-Connector

Width	List Price	Catalog Number
2" (51)	\$27	TRGHC

Build your complete Part Number here:

Sample Part Number:

TRGPFNY

Total Cost \$129 =

\$129

Horizontal Electrical Accessory

Horizontal Electrical Accessories provide power and data access, mounting to the back edge of a desk or work surface without a modesty panel.

The face plate is available in black or white. The outlet bezel and back of the unit is clear anodized aluminum. Includes a 6' power cord.

UL and CUL Listed.

Vertical Electrical Accessory

Vertical Electrical Accessories provide power and data access, mounting to the back of any desk or work surface without a modesty panel.

The face plate is available in black or white. The outlet bezel and back of the unit is clear anodized aluminum. Includes a 6' power cord.

UL and CUL Listed.

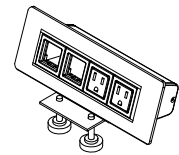

HEA2P2DB

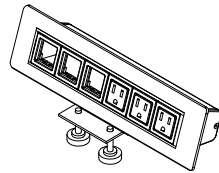

HEA3P3DB

Horizontal Electrical Accessory

Description	List Price	Catalog Number
Black Face Plate		
two power outlets, one USB	\$523	HEA2P1UB
two power outlets, one Ipod Dock	695	HEA2P1PB
two power outlets, two data openings	331	HEA2P2DB
three power outlets, one Extron Bracket	442	HEA3P1EB
three power outlets, three data openings	420	HEA3P3DB
White Face Plate		
two power outlets, one USB	\$523	HEA2P1UW
two power outlets, one Ipod Dock	695	HEA2P1PW
two power outlets, two data openings	331	HEA2P2DW
three power outlets, one Extron Bracket	442	HEA3P1EW
three power outlets, three data openings	420	HEA3P3DW



VEA2P2DB

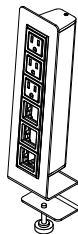

Vertical Electrical Accessory

Description	List Price	Catalog Number
Black Face Plate		
two power outlets, one USB	\$ 523	VEA2P1UB
two power outlets, two data openings	331	VEA2P2DB
three power outlets, one Extron Bracket	442	VEA3P1EB
three power outlets, three data openings	420	VEA3P3DB
White Face Plate		
two power outlets, one USB	\$ 523	VEA2P1UW
two power outlets, two data openings	331	VEA2P2DW
three power outlets, one Extron Bracket	442	VEA3P1EW
three power outlets, three data openings	420	VEA3P3DW

Build your complete Part Number here:

Sample Part Number:

HEA2P1UB

Total Cost \$523 =

\$523

Horizontal Sliding Electrical Accessory

The Horizontal Sliding Electrical Accessory provides 3 3/4" of sliding access to power and data. The body is anodized aluminum. The unit can be used on work surfaces that are 48" or 54" wide. It cannot be used on other work surface widths because they include a reinforcement bar which will obstruct the track.

UL and CUL Listed.

Ribbed Horizontal Electrical Accessory

Ribbed Horizontal Electrical Accessories provide power and data access, mounting to the back of any desk or work surface without a modesty panel.

The body is anodized aluminum.

Unit includes a 6' power cord.

UL and CUL Listed.

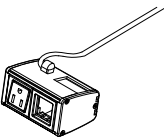
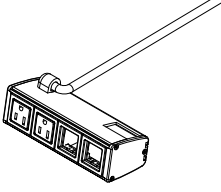
Horizontal Sliding Electrical Accessory			
	Description	List Price	Catalog Number
 HSEA1P1D	one power outlet, one data opening	\$344	HSEA1P1D
 HSEA2P2D	two power outlets, two data openings	366	HSEA2P2D

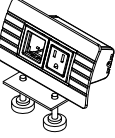
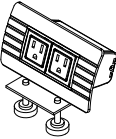
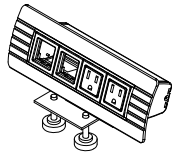
Ribbed Horizontal Electrical Accessory			
	Description	List Price	Catalog Number
 RHEA1P1D	one power outlet, one data opening	\$344	RHEA1P1D
 RHEA2P	one power outlet, one Extron Bracket	371	RHEA1P1E
 RHEA2P2D	two power outlets	358	RHEA2P
	two power outlets, one USB	557	RHEA2P1U
	two power outlets, one data opening, one USB	573	RHEA2P1D1U
	two power outlets, one Extron Bracket	392	RHEA2P1E
	two power outlets, one Ipad Dock	730	RHEA2P1P
	two power outlets, two data openings	366	RHEA2P2D
	three power outlets, two data openings	392	RHEA3P2D
	four power outlets	497	RHEA4P
	Build your complete Part Number here:		-----

Sample Part Number:

HSEA1P1D

Total Cost \$344 =

\$344

Trig Desking Accessories

Accessories 98

Monitor Arms 100

Task Light 102

Pedestal Pencil Tray

The Pencil Tray organizes small items in both the 6" (152) and 12" (305) Trig Pedestal drawers.

Available in black only.

Laminate Pedestal Side-to-Side Filing Bars

Side-to-Side Filing Bars convert Trig 12" Pedestal and storage tower drawers to side-to-side or legal-size filing.

Available in black only.

Vertical Wire Manager

The Vertical Wire Manager is designed to economically route wires from the floor to the work surface in a freestanding application. It can extend up to 30". The wire manager includes 15 vertibra rings, 1 base mount, 1 work surface mount, an edge clip and mounting screws.

Constructed of durable plastic, available in aluminum-toned finish only.

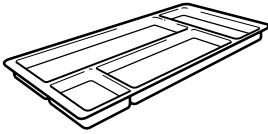

Pedestal Pencil Tray

Dimensions				List Price	Catalog Number
Depth	Width	Height	Description		
5 1/2" (140)	13 3/8" (340)	1" (25)	Includes 1 pencil tray.	\$18	HPPT

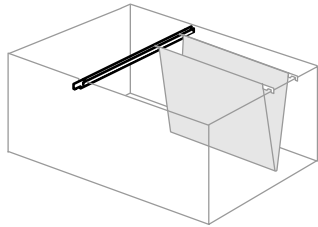

Laminate Pedestal Side-to-Side Filing Bars

Description	List Price	Catalog Number
Includes 6 hanging bars. Requires 1 per drawer.	\$71	ZFPSSB

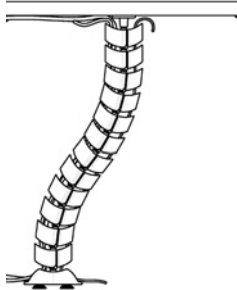

Vertical Wire Manager

	List Price	Catalog Number
	\$191	TRGVWMAL
Build your complete Part Number here:		_____

Sample Part Number: HPPT

Total Cost \$18 = \$18

Vertical Wire Channel

The Vertical Wire Channel encloses power or light cords on the face of a panel. It attaches to back panel with self-adhesive backing. Packaged in boxes of three.

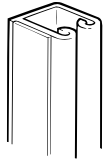

Horizontal Wire Manager

The Horizontal Wire Manager accommodates electrical cords and communication cables. It attaches under all work tops and desks. Includes mounting hardware.

Available in Black only.

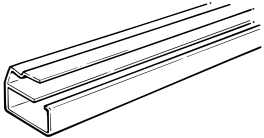

Grommet for Work Surface

The Work Surface Grommet is available for situations that require grommets in addition to standard locations or as replacements.

Available in black or silver.

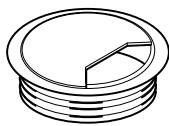

Vertical Wire Channel

Length	Dimensions Width	Depth	List Price	Catalog Number	Trim Color
24" (610)	1/2" (13)	1/2" (13)	\$28	VWC3	Standard Smooth Finish Only See Surface Materials Page 5
Package Contains 3 Wire Channels					

Horizontal Wire Manager

Depth	Dimensions Length	Height	List Price	Catalog Number
3" (76)	30" (762)	2" (51)	\$40	HWM30

Grommet for Work Surface

Depth	Dimensions Grommet Diameter	Drill Hole Diameter	List Price	Catalog Number		
15/16" (24)	2.8" (71)	2 ³ / ₈ " (60)	\$67	SIZGWS (Black)		
15/16" (24)	2.8" (71)	2 ³ / ₈ " (60)	\$67	SIGSGWS (Silver)		
Includes 6 grommets.						
Build your complete Part Number here:				<table border="1"> <tr> <td>----</td> <td>----</td> </tr> </table>	----	----
----	----					

Sample Part Number:	VWC3	.Y
Total Cost \$28 =	\$28	+ N/C

Monitor Arm

The monitor arms can be affixed to the back edge of the work surfaces between the panel and work surface or can also be bolted through the surface, with a drilled hole or grommet. The height can be adjusted 13" vertically and has 26" of reach. The arm can be adjusted to accurately counterbalance the weight of the monitor. Finally the arm can swivel 360 degrees. All this leads to an ergonomically correct viewing angle.

Available in silver only.

Single Monitor Arm

The monitor arm will support any VESA compliant monitor with both 75mm and 100mm mounting holes up to 14 lbs.

Dual Monitor Arm

The monitor arm will support any VESA compliant monitor with both 75mm and 100mm mounting holes up to 20 lbs total. Measured diagonally, the maximum screen width for each monitor is 22".

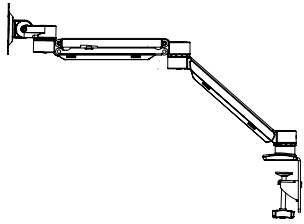

Single Monitor Arm

	List Price	Catalog Number
	\$454	MARMSNGL

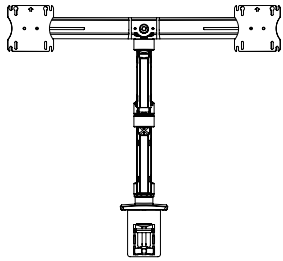

Dual Monitor Arm – Desk Mount

	List Price	Catalog Number
	\$599	MARMDUAL

Build your complete Part Number here: _____

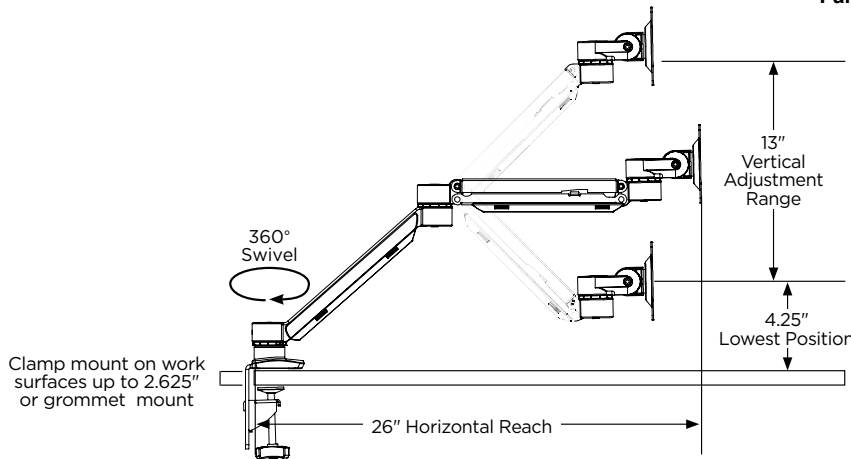

Sample Part Number:

MARMSNGL

Total Cost \$454 =

\$454

Freestanding Touch Up Markers

The Touch Up Markers are for use with the Thermofused Laminate. They are available individually or as a kit. The kit includes one marker of each color.

Freestanding Touch Up Markers

Description	List Price	Catalog Number
Wild Cherry	\$ 73	ZFTUPXZ1
Fusion Maple	73	ZFTUPXZ2
Empire Mahogany	73	ZFTUPXZ3
Black	73	ZFTUPXZ4
Chocolate Pear	73	ZFTUPXZ5
Kit (all 5 colors)	204	ZFTUPKIT
Build your complete Part Number here:		-----

Sample
Part Number:

ZFTUPXZ3

Total Cost \$73 =

\$73

Luma Touch™ LED Desk Lamp

The Luma Touch LED personal task light is specified with either a Round or an Elongated lamp style. The Lamp can be selected with a Freestanding Base, Clamp Mount, or Slatwall Mount. The Slatwall Mount is compatible with Choices and Capture. Its double-arm articulated design allows the user to position the light effortlessly for optimum illumination. The single control responds to the lightest touch to turn on, turn off or dim to the perfect level. Once dimmed, the lamp will resume the same lighting

level if turned off and on. The optional Occupancy Sensor turns the lamp on when a user approaches and shuts it off after 30 minutes of inactivity, conserving energy use. Available in three colors. ETL, TAA and BAA certified.

complements any interior. The single control responds to turn on, turn off or dim to the perfect level. Once dimmed, the lamp will resume the same lighting level if turned off and on. The Lamp is available as a freestanding model or with a clamp mount. UL Listed. Available in a Brushed Nickel finish

ORI LED Desk Lamp

The ORI LED Personal Task Light provides 390 Lumens of clear white light right where you need it. It offers a wide range of vertical and rotational adjustment so the user can direct the light where it's needed. The clean, simple and attractive design

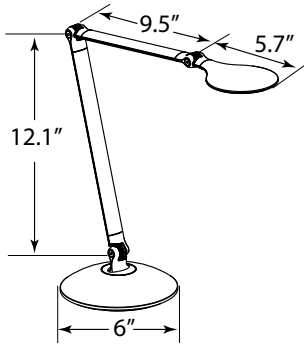

LumaTouch LED Desk Lamp - Circle

Description	List Price	Catalog Number	Occupancy Sensor	Color
Freestanding	\$ 629	LEDLTCRFS	OSN No Cost No Sensor	BK Black
Clamp Mount	629	LEDLTCRCP		
Slatwall Mount	629	LEDLTCRSW		
			OSY + \$211 Sensor	DW White PA Platinum

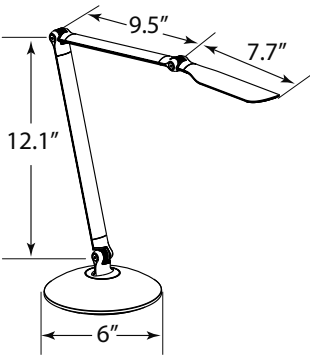

LumaTouch LED Desk Lamp - Elongated

Description	List Price	Catalog Number	Occupancy Sensor	Color
Freestanding	\$ 629	LEDLTEGFS		
Clamp Mount	629	LEDLTEGCP		
Slatwall Mount	629	LEDLTEGSW		

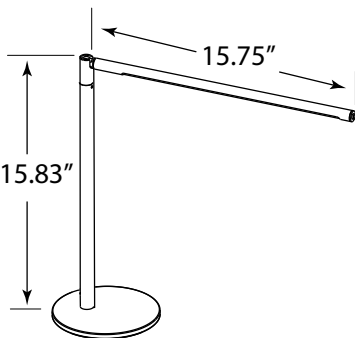

ORI LED Desk Lamp

Description	List Price	Catalog Number	Occupancy Sensor	Color
Freestanding Base	\$ 360	LEDORIFS		
Build your complete Part Number here:				
		---	---	--

Sample Part Number:

LEDLTCRFS	.OSN	.BK
-----------	------	-----

Total Cost \$629 =

\$629	+	N/C	+	N/C
-------	---	-----	---	-----

Terms, Policies & Index

<i>Terms & Policies</i>	<i>104</i>
<i>Warranty</i>	<i>107</i>
<i>Index</i>	<i>108</i>

1. Prices

Prices shown in this price list are F.O.B. origin, freight prepaid, in the contiguous United States. Trendway Corporation reserves the right to change prices without notice. Trendway may implement price changes effective at time of shipment if shipping date is more than 120 days from date written order was received by Trendway.

Pricing for shipments outside the contiguous United States will be based on the port of departure. Freight will be prepaid to port of departure.

List prices include coverage of prepaid standard, Trendway-specified freight cost.

2. Order Placement

Trendway Corporation requires all orders to be submitted electronically via on-line order entry at www.trenddealer.com, or in writing following Ordering Procedures on page 1. Trendway recommends using design software for larger projects which allows the dealer to design, specify, and enter an order more efficiently and accurately which will assure completeness and avoid errors and duplications. The Buyer assumes all responsibility for the correct content of any order which has been acknowledged.

3. Confirmation

Upon receiving an order, Trendway Corporation will send an acknowledgement with exact pricing information and scheduled shipping date. Orders can also be confirmed on-line at www.trenddealer.com. Customer is responsible for checking acknowledgements to ensure that the order is correct. Order will be processed as acknowledged.

4. Lead-Times

Trendway Corporation reserves the right to alter lead times as demand for products fluctuate. Stated lead-times begin after a complete order is entered and scheduled. Shipments are subject to product availability. Special products and larger orders may extend lead-times. Orders placed by dealers without a requested delivery date will be assigned a delivery date of 4 weeks for standard product orders and 6 weeks for custom product orders. Please contact your customer care representative for exact lead-times.

5. Buyer's Credit

If, in the judgment of Trendway, the financial condition of the Buyer at any time does not justify the terms specified, Trendway may at any time by notice to the Buyer require prepayment or other terms of payment differing from those specified in Section

8 or other satisfactory security to insure prompt payment of invoices.

6. Order Changes

To change an order, the customer must call Trendway Customer Care for order status. If approved, the customer must confirm the changes in writing to Trendway Corporation. Customer agrees to accept any and all charges involved in altering an order. This includes payment, determined by Trendway, for product already in production. Changes in orders also may result in delayed shipments.

7. Cancellation

All cancellations must be approved by Trendway Corporation. **Orders in production cannot be cancelled without incurring substantial or full purchase price.** Customers shall agree to accept any and all charges involved in the cancellation transaction, as determined by Trendway. Non-standard items may not be cancelled.

8. Terms of Sale

Terms of sale on all invoices to approved Trendway customers are Net 30 days from date of invoice. These terms may be changed at any time by Trendway Corporation based on credit rating information available on specific customers. Payment in advance may be requested at the discretion of Trendway without explanation.

9. Taxes

Prices listed do not include any federal, state, local, or other taxes. Purchaser agrees to pay or reimburse any such taxes that Trendway Corporation, Trendway Corporation subcontractors, or suppliers are required to pay. For shipments to AZ, CA, CO, DC, FL, GA, IL, IN, KS, MA, MI, MN, MS, NJ, NY, OH, PA, TX and Canada, add appropriate tax rate. All authorized dealers should ensure that a resale exemption certificate is on file with Trendway Corporation.

10. Past-Due Accounts

Past-due accounts will be charged 1.5% per month. This is an annual rate of 18% or the highest legal rate on the unpaid balance. The purchaser agrees to pay all collection agency fees, court costs, and/or reasonable attorney fees incurred by Trendway in the collection of past-due balances.

11. Customer's Own Material (COM)

The Trendway COM program allows customers to use special materials. By complying with the COM testing for manufacturability procedure in the steps below, Trendway will be able to identify if your material is appropriate for application to the products you specify.

To comply with the COM process, please follow these steps:

1. Select the COM material.
2. Check first with www.trenddealer.com/COM Library, to determine if this material has already passed testing for manufacturability on the intended product.
3. If the material is pre-approved in the COM Library, customer must submit a *COM Order Submission Form* (available from Trendway Customer Care Representative).
4. If the material requested is not in the COM Library, customer must submit a *COM* test request on-line at www.trenddealer.com, send a sample of the COM material (see Test Yardage Requirements below), and include a list of Trendway product numbers designated for the COM application. Material sample should include pattern name, pattern number and color, manufacturer, direction material should be applied, and Control number from the COM Request Form automated e-mail response.
5. Ship COM samples to:
U.S. Mail and UPS, FedEx Shipment:
Trendway Corporation
13467 Quincy Street
Holland, MI 49424
Attn: COM Request
6. You will be notified within five working days of receiving the material sample by Trendway, whether your COM has been approved or disapproved for application.

TEST YARDAGE REQUIREMENTS

Capture Tiles	1 yard
Choices panels	1½ yards
Fabric screens	2 yards
Flipper doors	2/3 yard
Intrinsic Freestanding	1 yard
Ped Cushions	1 yard
Seating	Trendway requests
Seating - Parley	1 yard
Seating - Zego	1½ yards
Tackboards	1 yard
TrendWall	4 yards
Volo tiles	4 yards

NOTE: Most fabric houses have a yardage minimum or an upcharge on less than one-yard cuts.

NOTE: All COM applications are priced at Grade 1 or Grade A.

If Buyer desires to use his own material in the production of Trendway's products, it is necessary to obtain the prior written consent of Trendway. Material provided by the Buyer shall be shipped to seller, freight prepaid, and all risk of loss or

damage shall remain with Buyer. Buyer must assume responsibility for any use spoilage that takes place in the course of processing or during transportation. Buyer hereby holds Trendway harmless against any and all claims for loss, liability, injury, or damage arising from use of customer material; and Buyer takes full responsibility for performance and quality of customer material. Buyer should also be aware that Buyer-furnished materials will not qualify for UL Listings and may not meet fire codes. Please discuss specific concerns and special needs with Trendway Customer Care PRIOR to placing your order.

11a. Custom Color

Trendway's Custom Color program allows the customer to specify their own color or stain on many of Trendway's products. See www.trenddealer.com for product availability, individual product guidelines and lead times. Set up fees and lead times are product specific and will vary.

To request a Custom Color or Stain:

- Complete a Custom Color Request form (available on www.trenddealer.com).
- Send request form along with two 2"x3" samples to Trendway Customer Care Color Coordinator.
- After the receipt of the request, Trendway will provide customer with one color sample.
- If approved, Dealer or customer completes custom color form, providing the custom match color number on the back of the sample, signs, and returns by fax or mail to Custom Color Coordinator.
- Samples will be matched under cool white florescent lighting. All orders processed under the Custom Color program will be manufactured within commercially acceptable tolerances.
- If applicable, dealer will be sent an invoice for \$250 color matching fee per customer, per color. See Custom Color Request form for details.

12. Special Product

When Trendway purchases special surface materials (i.e., fabrics and laminates) at the request of the customer, the customer takes full responsibility for the performance and quality of the surface material.

13. Delays

Trendway shall not be liable for loss or damage due to delay in manufacturing or delivery resulting from any cause beyond Trendway's reasonable control, including, but not limited to, compliance with any regulations,

orders, or instructions of any Federal, State, or Municipal Government, or any department or agency thereof, acts of God, acts or omissions of Buyer, acts of civil or military authority, fires, strikes, factory shutdowns or alterations, embargoes, war, riot, delays in transportation or inability due to causes beyond Trendway's reasonable control to obtain necessary labor, manufacturing facilities, or material from Trendway's usual sources. In no event shall Trendway be liable for special or consequential damages for any delay for any cause.

14. Postponement of Delivery

If unforeseen circumstances occur, Trendway Corporation may postpone delivery of ordered products. Customer will be notified when such postponement occurs.

15. Storage

When shipment is delayed by the Buyer, Trendway reserves the right to place the goods in storage at customer's risk and cost. Trendway charges 1/4 of 1% of list price per week to cover storage. All terms and conditions of the sale, including but not limited to invoicing and payment, will continue as Buyer-specified destination; except that title remains with Trendway and that Trendway reserves the right to modify payment terms to assure recovery of any additional cost incurred.

16. Transportation

All orders shipped to any destination, within the contiguous United States, will be F.O.B. origin, freight prepaid, and risk of loss or damage shall pass to Buyer upon delivery to carrier. Trendway will determine the method and agency of transportation to be used.

Exceptions to standard prepaid freight are as follows:

- Customer directed expedites (Air Freight, Team Hauls) will be prepaid by Trendway and Customer will be billed the difference between standard and expedited freight.
- Truckload deliveries that are requested to deliver on weekends, Holidays or after 12:00 noon EST on Friday's will have an additional charge of \$450 per truck.
- Excessive unloading (in excess of 2 hours) will be billed at \$50 per hour after the initial 4 hour unloading period.
- LTL shipments normally deliver between 8:00 am and 5:00 pm, Monday through Friday. A specific delivery time on your assigned delivery date can be requested for an additional charge of \$150. This charge does not

apply to full-truckload shipments. Requests for specific dates/times falling outside standard delivery timeframe for the carrier serving your area constitute Expedites (see Customer-Directed Expedites, above). Expedite charges do apply to full-truckload shipments.

- Lift gate service will have an additional charge of \$85 for an LTL carrier. For lift gate service on a truckload, contact Customer Care.
- Inside delivery service starts at \$50. Call Customer Care for quote.
- Reconsignment cost after shipment, starts at \$50. Call Customer Care for quote.
- Special equipment requirements call for a quote.

In the event that special F.O.B. Destination terms are agreed to by Trendway or delivery is made on Trendway-owned or -leased equipment, customer or authorized representative is responsible for noting any freight damage or shortage on the freight bill of lading at time of delivery and must notify Trendway within five (5) days of delivery day of any such damage or shortage. Assistance in a concealed damage claim on an F.O.B. Destination shipment will be provided by Trendway only if the product has been immediately unpacked and both the carrier and Trendway have been promptly notified of resultant damage so the proper inspection can be made.

Shipping Note:

Trendway strives to minimize packaging to help the environment and to make installations faster and cleaner.

Trendway ships products in using various packaging methods based upon the product type and shipping method (full truck vs. LTL), all of which are designed to provide protection for the product while minimizing packaging materials.

Trendway test packaging designs to ensure their effectiveness.

17. Product Ownership

Title and risk of loss to all goods sold shall pass to Buyer upon Trendway's delivery to Buyer or to a carrier at shipping point. Trendway, however, retains the Purchase Money Security Interest in all goods shipped and the right to perfect same.

18. Damaged Materials

Trendway Corporation is not responsible for shipped products when the

common carrier is in receipt of the material. Trendway expects all customers to thoroughly inspect orders on receipt regardless of point of delivery. Clear receipt should not be given on the material until it has been checked for damage in transit. All claims for noted damaged material must be made by the customer to Trendway Customer Care.

Concealed damage or damage not noted at time of delivery shall be made by the customer to the common carrier within 5 days after receipt. Trendway assumes no liability for such damage.

19. Shortage on Order

Shortage on ordered products must be reported to Trendway Corporation within five (5) days of product delivery and must be noted on bill of lading at time of delivery.

20. Product Usage and Compliance

Buyer assumes full responsibility for the application of Trendway's product to Buyer's use, and compliance with Trendway installation and maintenance instructions and reasonable load restrictions. Compliance to local code restrictions regarding fire, electrical, and building codes are the responsibility of the customer or his authorized agent.

21. Post-Delivery Assistance

Installation and servicing of Trendway products are normally handled directly by Trendway-authorized dealers. When this is not possible, assistance is available by calling Trendway's Customer Care Department, Holland, Michigan.

22. Returned Goods

As a basic policy, Trendway does not accept returned material, because most items are manufactured per order and are not in stock at the factory. If material is authorized for return because of Trendway error, shipment may be made freight collect. Any other goods for which Trendway does authorize a return will be sent prepaid and a restocking charge of 35% will apply. **To receive authorization to return goods, please contact Trendway's Customer Care Department.**

All Returned Materials Authorizations expire thirty (30) days from date of issue. Any product returned after 30 days will be refused and returned to sender collect.

Electrical components, nonstandard items, and fabric-covered goods may not be returned. Replacement products will be billed to you with credit being issued upon return of the product in good condition. All goods returned must be in the original Trendway packing cartons. Goods will be inspected for damage upon return. No credit will be issued for goods which are damaged. **As a**

general statement of policy, return authorization will not be issued for items unless they are Trendway stock items.

23. Special Marking or Tagging

Special tagging is available on all orders free of charge. Trendway suggests this option to simplify the staging and installation of product. **Tag designations must be specified at the time an order is placed.**

24. Trendway Field Technical and Installation Support:

On-site field measurement and installation support is available as a service. The fees are listed below:

Field Installation Assistance: 2 Day On-Site, \$1,200

Field Installation Assistance: 3 Days On-Site, \$1,800

Field Installation Assistance: 4 Days On-site, \$2,400

Field Installation Assistance: 5 Days On-Site, \$3,000

Days include 1/2 day travel to and 1/2 day travel from location. These fees are based on a minimum 14 business days advanced notification and booking. Service requests booked less than 14 business days in advance may be subject to additional fees due to added travel cost. For more information or to place a request, contact Trendway Customer Care at 1-616-399-3900.

Find the most current terms and conditions on www.Trendway.com, in the Price list section.

Limited Lifetime Warranty

Trendway Corporation warrants to the original purchaser that the products described in its price lists, sold after August 1, 2004 will be free from defects in materials and workmanship commencing with the date of initial purchase and continuing for as long as the original owner uses these products. This warranty provides limits on the following products:

	Systems	Architectural Products	Seating
10 Year	<ul style="list-style-type: none"> •Electrical Components •Height-Adjustable Table Frame 		<ul style="list-style-type: none"> •Pneumatic Cylinders •Mechanisms
5 Year	<ul style="list-style-type: none"> •Drawer Slides •Systems Textiles •Finishes •Electronic Ballasts •Height-Adjustable Table Mechanical Components •Screens 	<ul style="list-style-type: none"> •System Textiles •Finishes 	
3 Year	<ul style="list-style-type: none"> •Veneer •Magnetic Ballasts 		<ul style="list-style-type: none"> •Trim •Foam •Upholstery •Arm Pads
2 Year	<ul style="list-style-type: none"> •Surface Trend Fabrics •Height-Adjustable Table Electrical Components 	<ul style="list-style-type: none"> •Surface Trend Fabrics 	
1 Year	<ul style="list-style-type: none"> •Non-Standard Product •Personal Task Lighting 	<ul style="list-style-type: none"> •Non-Standard Product 	<ul style="list-style-type: none"> •Non-Standard Product
Not Covered	<ul style="list-style-type: none"> •Light Bulbs •Customer's Own Material 	<ul style="list-style-type: none"> •Customer's Own Material 	<ul style="list-style-type: none"> •Customer's Own Material

The following exceptions apply to all product lines:

- The Trendway warranty applies to normal three shift office use, with the exception of seating. Seating is warranted for single-shift usage.
- Damage caused by improper treatment of the product including exposure to unusual environmental conditions (extreme climates, acids, and moisture)

This comprehensive warranty applies to all products installed or reconfigured by a Trendway authorized installer. Trendway will repair, or at its option, replace defective merchandise, free of charge, which, when used normally and pursuant to Trendway's published instructions, and applicable planning guide information, prove to be defective within the period stated. This remedy is expressly agreed to be exclusive as a condition of sale. No person is authorized to assume for Trendway any warranty liability, except as expressly set forth in this paragraph, or set forth in writing by an authorized officer of the company at its headquarters in Holland, Michigan.

Any and all labor charge backs must be pre-approved by Trendway's Customer Care Manager in writing. Trendway will reimburse authorized Trendway dealers and service centers for approved warranty labor during the first year of use.

This warranty does not apply to damage resulting from accident, alteration, transport, or misuse, as well as damage from normal wear and tear such as dents, nicks, scratches, fading and improper maintenance. Trendway employs quality measures to ensure color consistency in our products. However, due to the effects of light and other environmental factors, no guarantee can be made for an exact match to product in an existing installation.

Natural variations occurring in materials such as wood and leather are not considered defects, and Trendway does not warrant the matching of colors, grains, textures or colorfastness of these materials.

Trendway provides a three-year warranty on veneer products for quality and craftsmanship. Due to the natural properties of wood, the following are not covered under this warranty:

- Changes in wood color resulting from exposure to light or aging
- Natural color variation between wood veneer and solid wood pieces, or resulting from veneer lay-up
- Natural variation in wood grain or the presence of character marks
- Normal wear and tear
- Exact match to swatch materials

Trendway makes no warranty to purchasers who acquire products for personal, family, or household purposes, or to purchasers acquiring the product other than directly from Trendway Corporation, its authorized dealers, or others who are specifically authorized by Trendway to sell such products. Trendway's liability with respect to its products shall not exceed that expressly set forth above irrespective of the theory upon which a claim might be based, including negligence. Under no circumstances shall Trendway be liable for incidental or consequential damages. Original product label must be attached to the product in question.

The warranty period is not interrupted or prolonged by the performance of a service under the terms of the warranty. There are no other warranties except as expressly set forth above, either express or implied, including any warranty of design, merchantability or fitness for any purpose.

This warranty supersedes all previously printed Trendway warranties.

Trendway Corporation
13467 Quincy St., Holland MI 49422-9016
www.trendway.com 09.12

Overview & Order Information
Statement of Line
Surface Materials
Desks & Work Surfaces
Screens & Modesties
Storage
Benching Electrical
Electrical
Accessories
Terms, Policies & Index

Catalog Number	Description	Page	Catalog Number	Description	Page
CFTP144	Ceiling Feed.....	86	SCNBECMS6630	Single Acrylic Screen - Edge Mount Bracket ..	46
CM552	Communication Modules.....	87	SCNBECMS7230	Single Acrylic Screen - Edge Mount Bracket..	46
CM553	Communication Modules.....	87	SCNDTCMS2424	Single Acrylic Screen - Top Mount Bracket.....	47
CM553BW	Communication Modules.....	87	SCNDTCMS3024	Single Acrylic Screen - Top Mount Bracket.....	47
CM554	Communication Modules.....	87	SCNDTCMS3624	Single Acrylic Screen - Top Mount Bracket.....	47
CM555	Communication Modules.....	87	SCNDTCMS4224	Single Acrylic Screen - Top Mount Bracket.....	47
CM6666	Communication Modules.....	87	SCNDTCMS4824	Single Acrylic Screen - Top Mount Bracket.....	47
EBFH	End Mount Feed	86	SCNDTCMS5424	Single Acrylic Screen - Top Mount Bracket.....	47
HEA2P1PB	Horizontal Electrical Accessory.....	95	SCNDTCMS6024	Single Acrylic Screen - Top Mount Bracket.....	47
HEA2P1PW	Horizontal Electrical Accessory.....	95	SCNDTCMS6624	Single Acrylic Screen - Top Mount Bracket.....	47
HEA2P1UB	Horizontal Electrical Accessory.....	95	SCNDTCMS7224	Single Acrylic Screen - Top Mount Bracket.....	47
HEA2P1UW	Horizontal Electrical Accessory.....	95	SCNDTCMS2430	Single Acrylic Screen - Top Mount Bracket.....	47
HEA2P2DB	Horizontal Electrical Accessory.....	95	SCNDTCMS3030	Single Acrylic Screen - Top Mount Bracket.....	47
HEA2P2DW	Horizontal Electrical Accessory.....	95	SCNDTCMS3630	Single Acrylic Screen - Top Mount Bracket.....	47
HEA3P1EB	Horizontal Electrical Accessory.....	95	SCNDTCMS4230	Single Acrylic Screen - Top Mount Bracket.....	47
HEA3P1EW	Horizontal Electrical Accessory.....	95	SCNDTCMS4830	Single Acrylic Screen - Top Mount Bracket.....	47
HEA3P3DB	Horizontal Electrical Accessory.....	95	SCNDTCMS5430	Single Acrylic Screen - Top Mount Bracket.....	47
HEA3PEDW	Horizontal Electrical Accessory.....	95	SCNDTCMS6030	Single Acrylic Screen - Top Mount Bracket.....	47
HPPT	Pedestal Pencil Tray	88	SCNDTCMS6630	Single Acrylic Screen - Top Mount Bracket.....	47
HSEA1P1D	Horizontal Sliding Electrical Accessory	96	SCNDTCMS7230	Single Acrylic Screen - Top Mount Bracket.....	47
HSEA2P2D	Horizontal Sliding Electrical Accessory	96	SCNSMPS2424	Single Acrylic Screen - Post Style Bracket	44
HWM30	Horizontal Wire Manager.....	99	SCNSMPS3024	Single Acrylic Screen - Post Style Bracket	44
LEDLTCRFS	Luma Touch LED Desk Lamp	102	SCNSMPS3624	Single Acrylic Screen - Post Style Bracket	44
LEDLTCRCP	Luma Touch LED Desk Lamp	102	SCNSMPS4224	Single Acrylic Screen - Post Style Bracket	44
LEDLTCRSW	Luma Touch LED Desk Lamp	102	SCNSMPS4824	Single Acrylic Screen - Post Style Bracket	44
LEDLTEGFS	Luma Touch LED Desk Lamp	102	SCNSMPS5424	Single Acrylic Screen - Post Style Bracket	44
LEDLTEGCP	Luma Touch LED Desk Lamp	102	SCNSMPS6024	Single Acrylic Screen - Post Style Bracket	44
LEDLTEGSW	Luma Touch LED Desk Lamp	102	SCNSMPS6624	Single Acrylic Screen - Post Style Bracket	44
LEDORIFS	ORI LED Desk Lamp	102	SCNSMPS7224	Single Acrylic Screen - Post Style Bracket	44
MARMSNGL	Monitor Arm - Desk Mount.....	100	SCNSMPS2430	Single Acrylic Screen - Post Style Bracket	44
MARMJUAL	Dual Monitor Arm.....	100	SCNSMPS3030	Single Acrylic Screen - Post Style Bracket	44
RHEA1P1D	Ribbed Horizontal Electrical Accessory.....	96	SCNSMPS3630	Single Acrylic Screen - Post Style Bracket	44
RHEA1P1E	Ribbed Horizontal Electrical Accessory.....	96	SCNSMPS4230	Single Acrylic Screen - Post Style Bracket	44
RHEA2P	Ribbed Horizontal Electrical Accessory.....	96	SCNSMPS4830	Single Acrylic Screen - Post Style Bracket	44
RHEA2P1D1U	Ribbed Horizontal Electrical Accessory.....	96	SCNSMPS5430	Single Acrylic Screen - Post Style Bracket	44
RHEA2P1E	Ribbed Horizontal Electrical Accessory.....	96	SCNSMPS6030	Single Acrylic Screen - Post Style Bracket	44
RHEA2P1P	Ribbed Horizontal Electrical Accessory.....	96	SCNSMPS6630	Single Acrylic Screen - Post Style Bracket	44
RHEA2P1U	Ribbed Horizontal Electrical Accessory.....	96	SCNSMPS7230	Single Acrylic Screen - Post Style Bracket	44
RHEA2P2D	Ribbed Horizontal Electrical Accessory.....	96	SCNSMPS2436	Single Acrylic Screen - Post Style Bracket	44
RHEA3P2D	Ribbed Horizontal Electrical Accessory.....	96	SCNSMPS3036	Single Acrylic Screen - Post Style Bracket	44
RHEA4P	Ribbed Horizontal Electrical Accessory.....	96	SCNSMPS3636	Single Acrylic Screen - Post Style Bracket	44
SCNAFS2424	Single Acrylic Screen - Freestanding Plate	45	SCNSMPS4236	Single Acrylic Screen - Post Style Bracket	44
SCNAFS3024	Single Acrylic Screen - Freestanding Plate	45	SCNSMPS4836	Single Acrylic Screen - Post Style Bracket	44
SCNAFS3624	Single Acrylic Screen - Freestanding Plate	45	SCNSMPS5436	Single Acrylic Screen - Post Style Bracket	44
SCNAFS4224	Single Acrylic Screen - Freestanding Plate	45	SCNSMPS6036	Single Acrylic Screen - Post Style Bracket	44
SCNAFS4824	Single Acrylic Screen - Freestanding Plate	45	SCNSMPS6636	Single Acrylic Screen - Post Style Bracket	44
SCNAFS5424	Single Acrylic Screen - Freestanding Plate	45	SCNSMPS7236	Single Acrylic Screen - Post Style Bracket	44
SCNAFS6024	Single Acrylic Screen - Freestanding Plate	45	SCNSMPU362424	U-Shape Acrylic Screen - Post Style Bracket... 48	
SCNAFS6624	Single Acrylic Screen - Freestanding Plate	45	SCNSMPU422424	U-Shape Acrylic Screen - Post Style Bracket... 48	
SCNAFS7224	Single Acrylic Screen - Freestanding Plate	45	SCNSMPU482424	U-Shape Acrylic Screen - Post Style Bracket... 48	
SCNAFS2430	Single Acrylic Screen - Freestanding Plate	45	SCNSMPU542424	U-Shape Acrylic Screen - Post Style Bracket... 48	
SCNAFS3030	Single Acrylic Screen - Freestanding Plate	45	SCNSMPU602424	U-Shape Acrylic Screen - Post Style Bracket... 48	
SCNAFS3630	Single Acrylic Screen - Freestanding Plate	45	SCNSMPU662424	U-Shape Acrylic Screen - Post Style Bracket... 48	
SCNAFS4230	Single Acrylic Screen - Freestanding Plate	45	SCNSMPU722424	U-Shape Acrylic Screen - Post Style Bracket... 48	
SCNAFS4830	Single Acrylic Screen - Freestanding Plate	45	SCNSMPU363024	U-Shape Acrylic Screen - Post Style Bracket... 48	
SCNAFS5430	Single Acrylic Screen - Freestanding Plate	45	SCNSMPU423024	U-Shape Acrylic Screen - Post Style Bracket... 48	
SCNAFS6030	Single Acrylic Screen - Freestanding Plate	45	SCNSMPU483024	U-Shape Acrylic Screen - Post Style Bracket... 48	
SCNAFS6630	Single Acrylic Screen - Freestanding Plate	45	SCNSMPU543024	U-Shape Acrylic Screen - Post Style Bracket... 48	
SCNAFS7230	Single Acrylic Screen - Freestanding Plate	45	SCNSMPU603024	U-Shape Acrylic Screen - Post Style Bracket... 48	
SCNBECMS2424	Single Acrylic Screen - Edge Mount Bracket ..	46	SCNSMPU663024	U-Shape Acrylic Screen - Post Style Bracket... 48	
SCNBECMS3024	Single Acrylic Screen - Edge Mount Bracket ..	46	SCNSMPU723024	U-Shape Acrylic Screen - Post Style Bracket... 48	
SCNBECMS3624	Single Acrylic Screen - Edge Mount Bracket ..	46	SCNSMPU362430	U-Shape Acrylic Screen - Post Style Bracket... 48	
SCNBECMS4224	Single Acrylic Screen - Edge Mount Bracket ..	46	SCNSMPU422430	U-Shape Acrylic Screen - Post Style Bracket... 48	
SCNBECMS4824	Single Acrylic Screen - Edge Mount Bracket ..	46	SCNSMPU482430	U-Shape Acrylic Screen - Post Style Bracket... 48	
SCNBECMS5424	Single Acrylic Screen - Edge Mount Bracket ..	46	SCNSMPU542430	U-Shape Acrylic Screen - Post Style Bracket... 48	
SCNBECMS6024	Single Acrylic Screen - Edge Mount Bracket ..	46	SCNSMPU602430	U-Shape Acrylic Screen - Post Style Bracket... 48	
SCNBECMS6624	Single Acrylic Screen - Edge Mount Bracket ..	46	SCNSMPU662430	U-Shape Acrylic Screen - Post Style Bracket... 48	
SCNBECMS7224	Single Acrylic Screen - Edge Mount Bracket ..	46	SCNSMPU722430	U-Shape Acrylic Screen - Post Style Bracket... 48	
SCNBECMS2430	Single Acrylic Screen - Edge Mount Bracket ..	46	SCNSMPU363030	U-Shape Acrylic Screen - Post Style Bracket... 48	
SCNBECMS3030	Single Acrylic Screen - Edge Mount Bracket ..	46	SCNSMPU423030	U-Shape Acrylic Screen - Post Style Bracket... 48	
SCNBECMS3630	Single Acrylic Screen - Edge Mount Bracket ..	46	SCNSMPU483030	U-Shape Acrylic Screen - Post Style Bracket... 48	
SCNBECMS4230	Single Acrylic Screen - Edge Mount Bracket ..	46	SCNSMPU543030	U-Shape Acrylic Screen - Post Style Bracket... 48	
SCNBECMS4830	Single Acrylic Screen - Edge Mount Bracket ..	46	SCNSMPU663030	U-Shape Acrylic Screen - Post Style Bracket... 48	
SCNBECMS5430	Single Acrylic Screen - Edge Mount Bracket ..	46	SCNSMPU723030	U-Shape Acrylic Screen - Post Style Bracket... 48	
SCNBECMS6030	Single Acrylic Screen - Edge Mount Bracket ..	46	SCNSMPU362436	U-Shape Acrylic Screen - Post Style Bracket... 48	

Catalog Number	Description	Page	Catalog Number	Description	Page
SCNSMPU422436	U-Shape Acrylic Screen - Post Style Bracket...48	48	TRGBMS4813	Trig Back Edge Mount Screens.....42	42
SCNSMPU482436	U-Shape Acrylic Screen - Post Style Bracket...48	48	TRGBMS4819	Trig Back Edge Mount Screens.....42	42
SCNSMPU542436	U-Shape Acrylic Screen - Post Style Bracket...48	48	TRGBMS5413	Trig Back Edge Mount Screens.....42	42
SCNSMPU602436	U-Shape Acrylic Screen - Post Style Bracket...48	48	TRGBMS5419	Trig Back Edge Mount Screens.....42	42
SCNSMPU662436	U-Shape Acrylic Screen - Post Style Bracket...48	48	TRGBMS6013	Trig Back Edge Mount Screens.....42	42
SCNSMPU722436	U-Shape Acrylic Screen - Post Style Bracket...48	48	TRGBMS6019	Trig Back Edge Mount Screens.....42	42
SCNSMPU363036	U-Shape Acrylic Screen - Post Style Bracket...48	48	TRGBMS6613	Trig Back Edge Mount Screens.....42	42
SCNSMPU423036	U-Shape Acrylic Screen - Post Style Bracket...48	48	TRGBMS6619	Trig Back Edge Mount Screens.....42	42
SCNSMPU483036	U-Shape Acrylic Screen - Post Style Bracket...48	48	TRGBMS7213	Trig Back Edge Mount Screens.....42	42
SCNSMPU543036	U-Shape Acrylic Screen - Post Style Bracket...48	48	TRGBMS7219	Trig Back Edge Mount Screens.....42	42
SCNSMPU603036	U-Shape Acrylic Screen - Post Style Bracket...48	48	TRGBMSM2428	Trig Screen/Modesty Combination.....43	43
SCNSMPU663036	U-Shape Acrylic Screen - Post Style Bracket...48	48	TRGBMSM3028	Trig Screen/Modesty Combination.....43	43
SCNSMPU723036	U-Shape Acrylic Screen - Post Style Bracket...48	48	TRGBMSM3628	Trig Screen/Modesty Combination.....43	43
SCNTDMU362424	U-Shape Acrylic Screen - Low Profile Bracket.49	49	TRGBMSM4228	Trig Screen/Modesty Combination.....43	43
SCNTDMU422424	U-Shape Acrylic Screen - Low Profile Bracket.49	49	TRGBMSM4828	Trig Screen/Modesty Combination.....43	43
SCNTDMU482424	U-Shape Acrylic Screen - Low Profile Bracket.49	49	TRGBMSM5428	Trig Screen/Modesty Combination.....43	43
SCNTDMU542424	U-Shape Acrylic Screen - Low Profile Bracket.49	49	TRGBMSM6028	Trig Screen/Modesty Combination.....43	43
SCNTDMU602424	U-Shape Acrylic Screen - Low Profile Bracket.49	49	TRGBMSM6628	Trig Screen/Modesty Combination.....43	43
SCNTDMU662424	U-Shape Acrylic Screen - Low Profile Bracket.49	49	TRGBMSM7228	Trig Screen/Modesty Combination.....43	43
SCNTDMU722424	U-Shape Acrylic Screen - Low Profile Bracket.49	49	TRGBSWSL13	Bench Storage W/S Short Support.....39	39
SCNTDMU763024	U-Shape Acrylic Screen - Low Profile Bracket.49	49	TRGBSWSL19	Bench Storage W/S Short Support.....39	39
SCNTDMU423024	U-Shape Acrylic Screen - Low Profile Bracket.49	49	TRGC2DD60	Trig Credenzas with Doors.....51	51
SCNTDMU483024	U-Shape Acrylic Screen - Low Profile Bracket.49	49	TRGC2DDCS72	Trig Credenzas with Doors.....51	51
SCNTDMU543024	U-Shape Acrylic Screen - Low Profile Bracket.49	49	TRGC2DDCS75	Trig Credenzas with Doors.....51	51
SCNTDMU603024	U-Shape Acrylic Screen - Low Profile Bracket.49	49	TRGC2LAT60	Trig Credenzas with Laterals.....53	53
SCNTDMU663024	U-Shape Acrylic Screen - Low Profile Bracket.49	49	TRGC2LATCS72	Trig Credenza with Laterals.....53	53
SCNTDMU723024	U-Shape Acrylic Screen - Low Profile Bracket.49	49	TRGC2LATCS75	Trig Credenzas with Laterals.....53	53
SCNTDMU362430	U-Shape Acrylic Screen - Low Profile Bracket.49	49	TRGCBC30	Trig Bookcase.....57	57
SCNTDMU422430	U-Shape Acrylic Screen - Low Profile Bracket.49	49	TRGCBC36	Trig Bookcase.....57	57
SCNTDMU482430	U-Shape Acrylic Screen - Low Profile Bracket.49	49	TRGCDDOSR60	Trig Credenza w/ Doors & Shelves.....52	52
SCNTDMU542430	U-Shape Acrylic Screen - Low Profile Bracket.49	49	TRGCDDOSL60	Trig Credenza w/ Doors & Shelves.....52	52
SCNTDMU602430	U-Shape Acrylic Screen - Low Profile Bracket.49	49	TRGCDDSDL45	Trig Credenzas with Doors.....51	51
SCNTDMU662430	U-Shape Acrylic Screen - Low Profile Bracket.49	49	TRGCDDSDR45	Trig Credenzas with Doors.....51	51
SCNTDMU722430	U-Shape Acrylic Screen - Low Profile Bracket.49	49	TRGCLATOS30	Trig Credenzas with Laterals.....53	53
SCNTDMU363030	U-Shape Acrylic Screen - Low Profile Bracket.49	49	TRGCLATOSL45	Trig Credenzas with Laterals.....53	53
SCNTDMU423030	U-Shape Acrylic Screen - Low Profile Bracket.49	49	TRGCLATOSL48	Trig Credenza with Laterals.....53	53
SCNTDMU483030	U-Shape Acrylic Screen - Low Profile Bracket.49	49	TRGCLATOSL60	Trig Credenza with Laterals.....53	53
SCNTDMU543030	U-Shape Acrylic Screen - Low Profile Bracket.49	49	TRGCLATOSR48	Trig Credenza with Laterals.....53	53
SCNTDMU603030	U-Shape Acrylic Screen - Low Profile Bracket.49	49	TRGCLATOSR60	Trig Credenza with Laterals.....53	53
SCNTDMU663030	U-Shape Acrylic Screen - Low Profile Bracket.49	49	TRGCLATOSR45	Trig Credenzas with Laterals.....53	53
SCNTDMU723030	U-Shape Acrylic Screen - Low Profile Bracket.49	49	TRGCLATSDDL45	Trig Credenzas with Doors and Laterals.....54	54
SICSP	Flush Support Plates.....40	40	TRGCLATSDDR45	Trig Credenzas with Doors and Laterals.....54	54
SIGSGWS	Grommet for Work Surface.....99	99	TRGCOS30	Trig Credenzas - Open Storage.....55	55
SIZGWS	Grommet for Work Surface.....99	99	TRGCOS36	Trig Credenzas - Open Storage.....55	55
TRG612LAT20	Trig Freestanding Lateral.....56	56	TRGCOS45	Trig Credenzas - Open Storage.....55	55
TRG612LAT2036	Trig Freestanding Lateral.....56	56	TRGCS6612OSL20	Trig Pedestal Shelf Comb Storage - L-Hand....63	63
TRG612PED20	Trig Freestanding Pedestal.....56	56	TRGCS6612OSL24	Trig Pedestal Shelf Comb Storage - L-Hand....63	63
TRGANGDL309424	Trig Blade Desk - Left-Hand.....29	29	TRGCS6612OSL30	Trig Pedestal Shelf Comb Storage - L-Hand....63	63
TRGANGDR249430	Trig Blade Desk - Right-Hand.....29	29	TRGCS6612OSR20	Trig Pedestal Shelf Comb Storage - R-Hand....63	63
TRGANGSL309424	Trig Blade Work Surface - Left-Hand.....35	35	TRGCS6612OSR24	Trig Pedestal Shelf Comb Storage - R-Hand....63	63
TRGANGSR249430	Trig Blade Work Surface - Right-Hand.....35	35	TRGCS6612OSR30	Trig Pedestal Shelf Comb Storage - R-Hand....63	63
TRGBCSTR661212	Trig Wardrobe Storage Tower w/ Bookcase.....68	68	TRGCSDDOS30	Trig Combination Storage.....62	62
TRGBCSTR666612	Trig Wardrobe Storage Tower w/ Bookcase.....68	68	TRGCSSLATOS30	Trig Combination Storage.....61	61
TRGBCSTL661212	Trig Wardrobe Storage Tower w/ Bookcase.....68	68	TRGCOSL45	Trig Combination Storage.....61	61
TRGBCSTL666612	Trig Wardrobe Storage Tower w/ Bookcase.....68	68	TRGCOSR45	Trig Combination Storage.....61	61
TRGBF2LAT60	Trig Bench-Height Storage.....59	59	TRGCPP144	Ceiling Power Pole.....85	85
TRGBF2LATCS72	Trig Bench-Height Storage.....59	59	TRGDD20	Trig Freestanding Double Door Storage.....57	57
TRGBF2LATCS75	Trig Bench-Height Storage.....59	59	TRGDD2036	Trig Freestanding Double Door Storage.....57	57
TRGBFBC30	Trig Bench-Height Bookcase.....60	60	TRGDR12	Trig Power Set.....93	93
TRGBFBC36	Trig Bench-Height Bookcase.....60	60	TRGEH18	Trig Electrical Harness.....93	93
TRGBFLAT30	Trig Bench-Height Storage.....58	58	TRGEH24	Trig Electrical Harness.....93	93
TRGBFLAT36	Trig Bench-Height Storage.....58	58	TRGEH30	Trig Electrical Harness.....93	93
TRGBFLATOSL45	Trig Bench-Height Storage.....58	58	TRGEH36	Trig Electrical Harness.....93	93
TRGBFLATOSL48	Trig Bench-Height Storage.....58	58	TRGEH42	Trig Electrical Harness.....93	93
TRGBFLATOSL60	Trig Bench-Height Storage.....58	58	TRGEH48	Trig Electrical Harness.....93	93
TRGBFLATOSR45	Trig Bench-Height Storage.....58	58	TRGEH54	Trig Electrical Harness.....93	93
TRGBFLATOSR48	Trig Bench-Height Storage.....58	58	TRGEH60	Trig Electrical Harness.....93	93
TRGBFLATOSR60	Trig Bench-Height Storage.....58	58	TRGEH66	Trig Electrical Harness.....93	93
TRGBMS2413	Trig Back Edge Mount Screens.....42	42	TRGEH72	Trig Electrical Harness.....93	93
TRGBMS2419	Trig Back Edge Mount Screens.....42	42	TRGEPDL305442	Trig Primary Desk - Left-Hand.....30	30
TRGBMS3013	Trig Back Edge Mount Screens.....42	42	TRGEPDL305448	Trig Primary Desk - Left-Hand.....30	30
TRGBMS3019	Trig Back Edge Mount Screens.....42	42	TRGEPDL306042	Trig Primary Desk - Left-Hand.....30	30
TRGBMS3613	Trig Back Edge Mount Screens.....42	42	TRGEPDL306048	Trig Primary Desk - Left-Hand.....30	30
TRGBMS3619	Trig Back Edge Mount Screens.....42	42	TRGEPDL306642	Trig Primary Desk - Left-Hand.....30	30
TRGBMS4213	Trig Back Edge Mount Screens.....42	42	TRGEPDL306648	Trig Primary Desk - Left-Hand.....30	30
TRGBMS4219	Trig Back Edge Mount Screens.....42	42	TRGEPDL307242	Trig Primary Desk - Left-Hand.....30	30

Overview & Order Information
Statement of Line
Surface Materials
Desks & Work Surfaces
Screens & Modesties
Storage
Benching Electrical
Electrical
Accessories
Terms, Policies & Index

Catalog Number	Description	Page	Catalog Number	Description	Page
TRGEPDL307248	Trig Primary Desk - Left-Hand.....	30	TRGESSL488420	Trig Secondary Work Surface - Left-Hand.....	37
TRGEPDL307842	Trig Primary Desk - Left-Hand.....	30	TRGESSR205442	Trig Secondary Work Surface - Right-Hand.....	37
TRGEPDL307848	Trig Primary Desk - Left-Hand.....	30	TRGESSR205448	Trig Secondary Work Surface - Right-Hand.....	37
TRGEPDL308442	Trig Primary Desk - Left-Hand.....	30	TRGESSR206042	Trig Secondary Work Surface - Right-Hand.....	37
TRGEPDL308448	Trig Primary Desk - Left-Hand.....	30	TRGESSR206048	Trig Secondary Work Surface - Right-Hand.....	37
TRGEPDR425430	Trig Primary Desk - Right-Hand.....	30	TRGESSR206642	Trig Secondary Work Surface - Right-Hand.....	37
TRGEPDR426030	Trig Primary Desk - Right-Hand.....	30	TRGESSR206648	Trig Secondary Work Surface - Right-Hand.....	37
TRGEPDR426630	Trig Primary Desk - Right-Hand.....	30	TRGESSR207242	Trig Secondary Work Surface - Right-Hand.....	37
TRGEPDR427230	Trig Primary Desk - Right-Hand.....	30	TRGESSR207248	Trig Secondary Work Surface - Right-Hand.....	37
TRGEPDR427830	Trig Primary Desk - Right-Hand.....	30	TRGESSR207842	Trig Secondary Work Surface - Right-Hand.....	37
TRGEPDR428430	Trig Primary Desk - Right-Hand.....	30	TRGESSR207848	Trig Secondary Work Surface - Right-Hand.....	37
TRGEPDR485430	Trig Primary Desk - Right-Hand.....	30	TRGESSR208442	Trig Secondary Work Surface - Right-Hand.....	37
TRGEPDR486030	Trig Primary Desk - Right-Hand.....	30	TRGESSR208448	Trig Secondary Work Surface - Right-Hand.....	37
TRGEPDR486630	Trig Primary Desk - Right-Hand.....	30	TRGFPP27	Floor Power Pole.....	81
TRGEPDR487230	Trig Primary Desk - Right-Hand.....	30	TRGFTMS1813	Top Mount Fabric Screen.....	50
TRGEPDR487830	Trig Primary Desk - Right-Hand.....	30	TRGFTMS2213	Top Mount Fabric Screen.....	50
TRGEPDR488430	Trig Primary Desk - Right-Hand.....	30	TRGFTMS2813	Top Mount Fabric Screen.....	50
TRGEPDSL305442	Trig Primary Work Surface - Left-Hand.....	36	TRGFTMS3613	Top Mount Fabric Screen.....	50
TRGEPDSL305448	Trig Primary Work Surface - Left-Hand.....	36	TRGFTMS4213	Top Mount Fabric Screen.....	50
TRGEPDSL306042	Trig Primary Work Surface - Left-Hand.....	36	TRGFTMS4813	Top Mount Fabric Screen.....	50
TRGEPDSL306048	Trig Primary Work Surface - Left-Hand.....	36	TRGFTMS5413	Top Mount Fabric Screen.....	50
TRGEPDSL306642	Trig Primary Work Surface - Left-Hand.....	36	TRGFTMS6013	Top Mount Fabric Screen.....	50
TRGEPDSL306648	Trig Primary Work Surface - Left-Hand.....	36	TRGFTMS6613	Top Mount Fabric Screen.....	50
TRGEPDSL307242	Trig Primary Work Surface - Left-Hand.....	36	TRGFTMS7213	Top Mount Fabric Screen.....	50
TRGEPDSL307248	Trig Primary Work Surface - Left-Hand.....	36	TRGFTMS1819	Top Mount Fabric Screen.....	50
TRGEPDSL307842	Trig Primary Work Surface - Left-Hand.....	36	TRGFTMS2219	Top Mount Fabric Screen.....	50
TRGEPDSL307848	Trig Primary Work Surface - Left-Hand.....	36	TRGFTMS2819	Top Mount Fabric Screen.....	50
TRGEPDSL308442	Trig Primary Work Surface - Left-Hand.....	36	TRGFTMS3619	Top Mount Fabric Screen.....	50
TRGEPDSL308448	Trig Primary Work Surface - Left-Hand.....	36	TRGFTMS4219	Top Mount Fabric Screen.....	50
TRGEPDR425430	Trig Primary Work Surface - Right-Hand.....	36	TRGFTMS4819	Top Mount Fabric Screen.....	50
TRGEPDR426030	Trig Primary Work Surface - Right-Hand.....	36	TRGFTMS5419	Top Mount Fabric Screen.....	50
TRGEPDR426630	Trig Primary Work Surface - Right-Hand.....	36	TRGFTMS6019	Top Mount Fabric Screen.....	50
TRGEPDR427230	Trig Primary Work Surface - Right-Hand.....	36	TRGFTMS6619	Top Mount Fabric Screen.....	50
TRGEPDR427830	Trig Primary Work Surface - Right-Hand.....	36	TRGFTMS7219	Top Mount Fabric Screen.....	50
TRGEPDR428430	Trig Primary Work Surface - Right-Hand.....	36	TRGFSMC2428	Fabric Screen/Modesty Combination.....	50
TRGEPDR485430	Trig Primary Work Surface - Right-Hand.....	36	TRGFSMC3028	Fabric Screen/Modesty Combination.....	50
TRGEPDR486030	Trig Primary Work Surface - Right-Hand.....	36	TRGFSMC3628	Fabric Screen/Modesty Combination.....	50
TRGEPDR486630	Trig Primary Work Surface - Right-Hand.....	36	TRGFSMC4228	Fabric Screen/Modesty Combination.....	50
TRGEPDR487230	Trig Primary Work Surface - Right-Hand.....	36	TRGFSMC4828	Fabric Screen/Modesty Combination.....	50
TRGEPDR487830	Trig Primary Work Surface - Right-Hand.....	36	TRGFSMC5428	Fabric Screen/Modesty Combination.....	50
TRGEPDR488430	Trig Primary Work Surface - Right-Hand.....	36	TRGFSMC6028	Fabric Screen/Modesty Combination.....	50
TRGESDL425420	Trig Secondary Desk - Left-Hand.....	31	TRGFSMC6628	Fabric Screen/Modesty Combination.....	50
TRGESDL426020	Trig Secondary Desk - Left-Hand.....	31	TRGFSMC7228	Fabric Screen/Modesty Combination.....	50
TRGESDL426620	Trig Secondary Desk - Left-Hand.....	31	TRGHC	Trig H-Connector.....	94
TRGESDL427220	Trig Secondary Desk - Left-Hand.....	31	TRGLCSPB1	Trig Support Leg to Panel Bracket.....	77
TRGESDL427820	Trig Secondary Desk - Left-Hand.....	31	TRGLCSPB2	Trig Support Leg to Panel Bracket.....	77
TRGESDL428420	Trig Secondary Desk - Left-Hand.....	31	TRGLCSPB3	Trig Support Leg to Panel Bracket.....	77
TRGESDL485420	Trig Secondary Desk - Left-Hand.....	31	TRGLDS1613	Trig Desk Top Screen.....	42
TRGESDL486020	Trig Secondary Desk - Left-Hand.....	31	TRGLDS168	Trig Desk Top Screen.....	42
TRGESDL486620	Trig Secondary Desk - Left-Hand.....	31	TRGLDS2013	Trig Desk Top Screen.....	42
TRGESDL487220	Trig Secondary Desk - Left-Hand.....	31	TRGLDS208	Trig Desk Top Screen.....	42
TRGESDL487820	Trig Secondary Desk - Left-Hand.....	31	TRGLDS2613	Trig Desk Top Screen.....	42
TRGESDL488420	Trig Secondary Desk - Left-Hand.....	31	TRGLDS268	Trig Desk Top Screen.....	42
TRGESDR205442	Trig Secondary Desk - Right-Hand.....	31	TRGLDS3813	Trig Desk Top Screen.....	42
TRGESDR205448	Trig Secondary Desk - Right-Hand.....	31	TRGLDS388	Trig Desk Top Screen.....	42
TRGESDR206042	Trig Secondary Desk - Right-Hand.....	31	TRGLDS4413	Trig Desk Top Screen.....	42
TRGESDR206048	Trig Secondary Desk - Right-Hand.....	31	TRGLDS448	Trig Desk Top Screen.....	42
TRGESDR206642	Trig Secondary Desk - Right-Hand.....	31	TRGMB1217	Trig Marker Boards.....	64
TRGESDR206648	Trig Secondary Desk - Right-Hand.....	31	TRGMB1617	Trig Marker Boards.....	64
TRGESDR207242	Trig Secondary Desk - Right-Hand.....	31	TRGMB2017	Trig Marker Boards.....	64
TRGESDR207248	Trig Secondary Desk - Right-Hand.....	31	TRGMB2417	Trig Marker Boards.....	64
TRGESDR207842	Trig Secondary Desk - Right-Hand.....	31	TRGMB3617	Trig Marker Boards.....	64
TRGESDR207848	Trig Secondary Desk - Right-Hand.....	31	TRGMOD24	Trig Modesty.....	43
TRGESDR208442	Trig Secondary Desk - Right-Hand.....	31	TRGMOD30	Trig Modesty.....	43
TRGESDR208448	Trig Secondary Desk - Right-Hand.....	31	TRGMOD36	Trig Modesty.....	43
TRGESSL425420	Trig Secondary Work Surface - Left-Hand.....	37	TRGMOD42	Trig Modesty.....	43
TRGESSL426020	Trig Secondary Work Surface - Left-Hand.....	37	TRGMOD48	Trig Modesty.....	43
TRGESSL426620	Trig Secondary Work Surface - Left-Hand.....	37	TRGMOD54	Trig Modesty.....	43
TRGESSL427220	Trig Secondary Work Surface - Left-Hand.....	37	TRGMOD60	Trig Modesty.....	43
TRGESSL427820	Trig Secondary Work Surface - Left-Hand.....	37	TRGMOD66	Trig Modesty.....	43
TRGESSL428420	Trig Secondary Work Surface - Left-Hand.....	37	TRGMOD72	Trig Modesty.....	43
TRGESSL485420	Trig Secondary Work Surface - Left-Hand.....	37	TRGODS48	Trig Overhead - Dual Sliding Door.....	74
TRGESSL486020	Trig Secondary Work Surface - Left-Hand.....	37	TRGODS54	Trig Overhead - Dual Sliding Door.....	74
TRGESSL486620	Trig Secondary Work Surface - Left-Hand.....	37	TRGODS60	Trig Overhead - Dual Sliding Door.....	74
TRGESSL487220	Trig Secondary Work Surface - Left-Hand.....	37	TRGODS66	Trig Overhead - Dual Sliding Door.....	74
TRGESSL487820	Trig Secondary Work Surface - Left-Hand.....	37	TRGODS72	Trig Overhead - Dual Sliding Door.....	74

Catalog Number	Description	Page	Catalog Number	Description	Page
TRGOHD60	Trig Overhead – Hinged Door	75	TRGRECS2060	Trig Rectangular Work Surface	32
TRGOHD66	Trig Overhead – Hinged Door	75	TRGRECS2066	Trig Rectangular Work Surface	32
TRGOHD72	Trig Overhead – Hinged Door	75	TRGRECS2072	Trig Rectangular Work Surface	32
TRGOHD78	Trig Overhead – Hinged Door	75	TRGRECS2078	Trig Rectangular Work Surface	32
TRGOHD84	Trig Overhead – Hinged Door	75	TRGRECS2084	Trig Rectangular Work Surface	32
TRGOOS48	Trig Overhead – Open Shelf	76	TRGRECS2448	Trig Rectangular Work Surface	32
TRGOOS54	Trig Overhead – Open Shelf	76	TRGRECS2454	Trig Rectangular Work Surface	32
TRGOOS60	Trig Overhead – Open Shelf	76	TRGRECS2460	Trig Rectangular Work Surface	32
TRGOOS66	Trig Overhead – Open Shelf	76	TRGRECS2466	Trig Rectangular Work Surface	32
TRGOOS72	Trig Overhead – Open Shelf	76	TRGRECS2472	Trig Rectangular Work Surface	32
TRGOOS84	Trig Overhead – Open Shelf	76	TRGRECS2478	Trig Rectangular Work Surface	32
TRGOSS48	Trig Overhead – Single Sliding Door	74	TRGRECS2484	Trig Rectangular Work Surface	32
TRGOSS54	Trig Overhead – Single Sliding Door	74	TRGRECS3048	Trig Rectangular Work Surface	32
TRGOSS60	Trig Overhead – Single Sliding Door	74	TRGRECS3054	Trig Rectangular Work Surface	32
TRGOSS66	Trig Overhead – Single Sliding Door	74	TRGRECS3060	Trig Rectangular Work Surface	32
TRGOSS72	Trig Overhead – Single Sliding Door	74	TRGRECS3066	Trig Rectangular Work Surface	32
TRGPBH30	Benching Electrical Harness	86	TRGRECS3072	Trig Rectangular Work Surface	32
TRGPBH42	Benching Electrical Harness	86	TRGRECS3078	Trig Rectangular Work Surface	32
TRGPBH48	Benching Electrical Harness	86	TRGRECS3084	Trig Rectangular Work Surface	32
TRGPBH54	Benching Electrical Harness	86	TRGSCSPB	Trig Storage to Panel Bracket	77
TRGPBH60	Benching Electrical Harness	86	TRGSOS3027	Stack Storage – Open Shelf	73
TRGPBH66	Benching Electrical Harness	86	TRGSOS3039	Stack Storage – Open Shelf	73
TRGPBH72	Benching Electrical Harness	86	TRGSPMS30	Stack Storage – Paper Management Shelf	73
TRGPBH78	Benching Electrical Harness	86	TRGSPMS45	Stack Storage – Paper Management Shelf	73
TRGPBH90	Benching Electrical Harness	86	TRGSPMS60	Stack Storage – Paper Management Shelf	73
TRGPD151	Power Duplexes	87	TRGSPMS75	Stack Storage – Paper Management Shelf	73
TRGPD152	Power Duplexes	87	TRGTB1217	Trig Tackboards	64
TRGPD153	Power Duplexes	87	TRGTB1617	Trig Tackboards	64
TRGPD154	Power Duplexes	87	TRGTB2017	Trig Tackboards	64
TRGPD151A	Power Duplexes	87	TRGTB2417	Trig Tackboards	64
TRGPD152A	Power Duplexes	87	TRGTB3617	Trig Tackboards	64
TRGPD153A	Power Duplexes	87	TRGTMS2413	Trig Surface Mount Screens	41
TRGPD153B	Power Duplexes	87	TRGTMS2419	Trig Surface Mount Screens	41
TRGPD154A	Power Duplexes	87	TRGTMS3013	Trig Surface Mount Screens	41
TRGPF	Trig Base Feed	94	TRGTMS3019	Trig Surface Mount Screens	41
TRGPFNY	Trig Base Feed New York	94	TRGTMS3613	Trig Surface Mount Screens	41
TRGPND1P1DB	Power Grommets	88	TRGTMS3619	Trig Surface Mount Screens	41
TRGPND1P1DW	Power Grommets	88	TRGTMS4213	Trig Surface Mount Screens	41
TRGPND1P1UB	Power Grommets	88	TRGTMS4219	Trig Surface Mount Screens	41
TRGPND1P1UW	Power Grommets	88	TRGTMS4813	Trig Surface Mount Screens	41
TRGPND2PB	Power Grommets	88	TRGTMS4819	Trig Surface Mount Screens	41
TRGPND2PW	Power Grommets	88	TRGTMS5413	Trig Surface Mount Screens	41
TRGPR24	Power Raceway	84	TRGTMS5419	Trig Surface Mount Screens	41
TRGPR30	Power Raceway	84	TRGTMS6013	Trig Surface Mount Screens	41
TRGPR36	Power Raceway	84	TRGTMS6019	Trig Surface Mount Screens	41
TRGPR42	Power Raceway	84	TRGTMS6613	Trig Surface Mount Screens	41
TRGPR48	Power Raceway	84	TRGTMS6619	Trig Surface Mount Screens	41
TRGPR54	Power Raceway	84	TRGTMS7213	Trig Surface Mount Screens	41
TRGPR60	Power Raceway	84	TRGTMS7219	Trig Surface Mount Screens	41
TRGPREC	Power Raceway End Cover	84	TRGTMS7813	Trig Surface Mount Screens	41
TRGPRSC12SL	Power Raceway Spanning Cover	84	TRGTMS7819	Trig Surface Mount Screens	41
TRGPRSC12DL	Power Raceway Spanning Cover	84	TRGTMS8413	Trig Surface Mount Screens	41
TRPRSC364R	Power Raceway Spanning Cover	84	TRGTMS8419	Trig Surface Mount Screens	41
TRGRECD2048	Trig Rectangular Desk	26	TRGTS1212DD54	Trig Lateral, Double-Door Storage Tower	66
TRGRECD2054	Trig Rectangular Desk	26	TRGTS1212DD66	Trig Lateral, Double-Door Storage Tower	66
TRGRECD2060	Trig Rectangular Desk	26	TRGTS1212OS54	Trig Lateral, Open Shelf Storage Tower	67
TRGRECD2066	Trig Rectangular Desk	26	TRGTS1212OS66	Trig Lateral, Open Shelf Storage Tower	67
TRGRECD2072	Trig Rectangular Desk	26	TRGTS6612DD54	Trig Lateral, Double-Door Storage Tower	66
TRGRECD2078	Trig Rectangular Desk	26	TRGTS6612DD66	Trig Lateral, Double-Door Storage Tower	66
TRGRECD2084	Trig Rectangular Desk	26	TRGTS6612OS54	Trig Lateral, Open Shelf Storage Tower	67
TRGRECD2448	Trig Rectangular Desk	26	TRGTS6612OS66	Trig Lateral, Open Shelf Storage Tower	67
TRGRECD2454	Trig Rectangular Desk	26	TRGTS66OS54	Trig Display Towers	67
TRGRECD2460	Trig Rectangular Desk	26	TRGTS66OS66	Trig Display Towers	67
TRGRECD2466	Trig Rectangular Desk	26	TRGTSDD54	Trig Storage Tower with Double-Door	65
TRGRECD2472	Trig Rectangular Desk	26	TRGTSDD66	Trig Storage Tower with Double-Door	65
TRGRECD2478	Trig Rectangular Desk	26	TRGTSOS54	Trig Display Towers	67
TRGRECD2484	Trig Rectangular Desk	26	TRGTSOS66	Trig Display Towers	67
TRGRECD3048	Trig Rectangular Desk	26	TRGTSSDL54	Trig Display Towers with Door	69
TRGRECD3054	Trig Rectangular Desk	26	TRGTSSDL66	Trig Display Towers with Door	69
TRGRECD3060	Trig Rectangular Desk	26	TRGTSDDR54	Trig Display Towers with Door	69
TRGRECD3066	Trig Rectangular Desk	26	TRGTSDDR66	Trig Display Towers with Door	69
TRGRECD3072	Trig Rectangular Desk	26	TRGTSWRR54	Trig Wardrobe Display Tower	70
TRGRECD3078	Trig Rectangular Desk	26	TRGTSWRR66	Trig Wardrobe Display Tower	70
TRGRECD3084	Trig Rectangular Desk	26	TRGTSWRL54	Trig Wardrobe Display Tower	70
TRGRECS2048	Trig Rectangular Work Surface	32	TRGTSWRL66	Trig Wardrobe Display Tower	70
TRGRECS2054	Trig Rectangular Work Surface	32			

	Catalog Number	Description	Page	Catalog Number	Description	Page
Overview & Order Information	TRGUDDD20	Trig Under Desk Dbl-Door Support Storage.....	72	TRGWEGL248430	Trig Wedge Work Surface - Left-Hand.....	34
	TRGUDDD24	Trig Under Desk Dbl-Door Support Storage.....	72	TRGWEGLR205424	Trig Wedge Work Surface - Right-Hand	35
	TRGUDDD30	Trig Under Desk Dbe-Door Support Storage ...	72	TRGWEGLR205430	Trig Wedge Work Surface - Right-Hand	33
	TRGUDLAT20	Trig Under Desk Lateral Support Storage	71	TRGWEGLR206024	Trig Wedge Work Surface - Right-Hand	33
	TRGUDLAT24	Trig Under Desk Lateral Support Storage	71	TRGWEGLR206030	Trig Wedge Work Surface - Right-Hand	33
	TRGUDLAT30	Trig Under Desk Lateral Support Storage	71	TRGWEGLR206624	Trig Wedge Work Surface - Right-Hand	33
	TRGUDPED20	Trig Under Desk Pedestal Support Storage	71	TRGWEGLR206630	Trig Wedge Work Surface - Right-Hand	33
	TRGUDPED24	Trig Under Desk Pedestal Support Storage	71	TRGWEGLR207224	Trig Wedge Work Surface - Right-Hand	33
	TRGUDPED30	Trig Under Desk Pedestal Support Storage	71	TRGWEGLR207230	Trig Wedge Work Surface - Right-Hand	33
	TRGULEG20	Trig Work Surface Support Legs.....	38	TRGWEGLR207824	Trig Wedge Work Surface - Right-Hand	33
Statement of Line	TRGULEG24	Trig Work Surface Support Legs.....	38	TRGWEGLR207830	Trig Wedge Work Surface - Right-Hand	33
	TRGULEG30	Trig Work Surface Support Legs.....	38	TRGWEGLR208424	Trig Wedge Work Surface - Right-Hand	33
	TRGULEG40	Trig Shared Work Surface Support Legs.....	38	TRGWEGLR208430	Trig Wedge Work Surface - Right-Hand	33
	TRGULEG48	Trig Shared Work Surface Support Legs.....	38	TRGWEGLR245430	Trig Wedge Work Surface - Right-Hand	33
	TRGULEG60	Trig Shared Work Surface Support Legs.....	38	TRGWEGLR246030	Trig Wedge Work Surface - Right-Hand	33
	TRGULEGSS20	Side to Side Shared Work Surface Support Leg	39	TRGWEGLR246630	Trig Wedge Work Surface - Right-Hand	33
	TRGULEGSS24	Side to Side Shared Work Surface Support Leg	39	TRGWEGLR247230	Trig Wedge Work Surface - Right-Hand	33
	TRGULEGSS30	Side to Side Shared Work Surface Support Leg	39	TRGWEGLR247830	Trig Wedge Work Surface - Right-Hand	33
	TRGULEGSS40	Side to Side Shared Work Surface Support Leg	39	TRGWEGLR248430	Trig Wedge Work Surface - Right-Hand	33
	TRGULEGSS48	Side to Side Shared Work Surface Support Leg	39	TRGWSBRKTS	Trig Work Surface Support Brackets	40
Surface Materials	TRGULEGSS60	Side to Side Shared Work Surface Support Leg	39	TRGWSRISER	Trig Support Riser.....	40
	TRGVMMAL	Vertical Wire Manager	98	TRGWSTR661212	Trig Wardrobe Storage Tower.....	65
	TRGWEGDL245420	Trig Wedge Desk - Left-Hand	28	TRGWSTR666612	Trig Wardrobe Storage Tower.....	65
	TRGWEGDL246020	Trig Wedge Desk - Left-Hand	28	TRGWSTL661212	Trig Wardrobe Storage Tower.....	65
	TRGWEGDL246620	Trig Wedge Desk - Left-Hand	28	TRGWSTL666612	Trig Wardrobe Storage Tower.....	65
	TRGWEGDL247220	Trig Wedge Desk - Left-Hand	28	VEA2P1UB	Vertical Electrical Accessory.....	82
	TRGWEGDL247820	Trig Wedge Desk - Left-Hand	28	VEA2P1UW	Vertical Electrical Accessory.....	95
	TRGWEGDL248420	Trig Wedge Desk - Left-Hand	28	VEA2P2DB	Vertical Electrical Accessory.....	95
	TRGWEGDL305420	Trig Wedge Desk - Left-Hand	28	VEA2P2DW	Vertical Electrical Accessory.....	95
	TRGWEGDL305424	Trig Wedge Desk - Left-Hand	28	VEA3P1EB	Vertical Electrical Accessory.....	95
Desks & Work Surfaces	TRGWEGDL306020	Trig Wedge Desk - Left-Hand	28	VEA3P1EW	Vertical Electrical Accessory.....	95
	TRGWEGDL306024	Trig Wedge Desk - Left-Hand	28	VEA3P3DB	Vertical Electrical Accessory.....	95
	TRGWEGDL306620	Trig Wedge Desk - Left-Hand	28	VEA3P3DW	Vertical Electrical Accessory.....	95
	TRGWEGDL306624	Trig Wedge Desk - Left-Hand	28	VWC3	Vertical Wire Channel	99
	TRGWEGDL307220	Trig Wedge Desk - Left-Hand	28	ZFPSSB	Laminate Pedestal Side-to-Side Filing Bars.....	98
	TRGWEGDL307224	Trig Wedge Desk - Left-Hand	28	ZFTUPKIT	Freestanding Touch Up Markers	101
	TRGWEGDL307820	Trig Wedge Desk - Left-Hand	28	ZFTUPXZ1	Freestanding Touch Up Markers	101
	TRGWEGDL307824	Trig Wedge Desk - Left-Hand	28	ZFTUPXZ2	Freestanding Touch Up Markers	101
	TRGWEGDL308420	Trig Wedge Desk - Left-Hand	28	ZFTUPXZ3	Freestanding Touch Up Markers	101
	TRGWEGDL308424	Trig Wedge Desk - Left-Hand	28	ZFTUPXZ4	Freestanding Touch Up Markers	101
Screens & Modesties	TRGWEGDL308424	Trig Wedge Desk - Left-Hand	28	ZFTUPXZ5	Freestanding Touch Up Markers	101
	TRGWEGDR205424	Trig Wedge Desk - Right-Hand.....	29			
	TRGWEGDR205430	Trig Wedge Desk - Right-Hand.....	27			
	TRGWEGDR206024	Trig Wedge Desk - Right-Hand.....	27			
	TRGWEGDR206030	Trig Wedge Desk - Right-Hand.....	27			
	TRGWEGDR206624	Trig Wedge Desk - Right-Hand.....	27			
	TRGWEGDR206630	Trig Wedge Desk - Right-Hand.....	27			
	TRGWEGDR207224	Trig Wedge Desk - Right-Hand.....	27			
	TRGWEGDR207230	Trig Wedge Desk - Right-Hand.....	27			
	TRGWEGDR207824	Trig Wedge Desk - Right-Hand.....	27			
Storage	TRGWEGDR207830	Trig Wedge Desk - Right-Hand.....	27			
	TRGWEGDR208424	Trig Wedge Desk - Right-Hand.....	27			
	TRGWEGDR208430	Trig Wedge Desk - Right-Hand.....	27			
	TRGWEGDR245430	Trig Wedge Desk - Right-Hand.....	27			
	TRGWEGDR246030	Trig Wedge Desk - Right-Hand.....	27			
	TRGWEGDR246630	Trig Wedge Desk - Right-Hand.....	27			
	TRGWEGDR247230	Trig Wedge Desk - Right-Hand.....	27			
	TRGWEGDR247830	Trig Wedge Desk - Right-Hand.....	27			
	TRGWEGDR248430	Trig Wedge Desk - Right-Hand.....	27			
	TRGWEGSL205424	Trig Wedge Work Surface - Left-Hand.....	36			
Benching Electrical	TRGWEGSL205430	Trig Wedge Work Surface - Left-Hand.....	36			
	TRGWEGSL206024	Trig Wedge Work Surface - Left-Hand.....	34			
	TRGWEGSL206030	Trig Wedge Work Surface - Left-Hand.....	34			
	TRGWEGSL206624	Trig Wedge Work Surface - Left-Hand.....	34			
	TRGWEGSL206630	Trig Wedge Work Surface - Left-Hand.....	34			
	TRGWEGSL207224	Trig Wedge Work Surface - Left-Hand.....	34			
	TRGWEGSL207230	Trig Wedge Work Surface - Left-Hand.....	34			
	TRGWEGSL207824	Trig Wedge Work Surface - Left-Hand.....	34			
	TRGWEGSL207830	Trig Wedge Work Surface - Left-Hand.....	34			
	TRGWEGSL208424	Trig Wedge Work Surface - Left-Hand.....	34			
Electrical	TRGWEGSL208430	Trig Wedge Work Surface - Left-Hand.....	34			
	TRGWEGSL208430	Trig Wedge Work Surface - Left-Hand.....	34			
	TRGWEGSL245430	Trig Wedge Work Surface - Left-Hand.....	34			
	TRGWEGSL246030	Trig Wedge Work Surface - Left-Hand.....	34			
	TRGWEGSL246630	Trig Wedge Work Surface - Left-Hand.....	34			
	TRGWEGSL247230	Trig Wedge Work Surface - Left-Hand.....	34			
	TRGWEGSL247830	Trig Wedge Work Surface - Left-Hand.....	34			
Accessories						
Terms, Policies & Index						

	Overview & Order Information
	Statement of Line
	Surface Materials
	Desks & Work Surfaces
	Screens & Modesties
	Storage
	Benching Electrical
	Electrical
	Accessories
	Terms, Policies & Index