Pack™

PRICE LIST | JANUARY 2022

For Canadian pricing, please visit Trendealer to see the current conversion rate being used or contact your local Trendway Representative.

Pack

The Pack filing and storage collection offers an exceptional range of sizes, configurations and functions to make your work life better. The Pack collection is SCS Certified - Indoor Advantage GOLD for indoor air quality.

Trendway product catalogs are available in the following design software: CAP, Data One, Giza, Midnight-Oil, and Project Matrix. The Pack price list is also available in .pdf (Acrobat Reader) format on dealer.trendway.com. For Architects and Designers, a free FSL (Furniture Symbol Library) is available on www.trendway.com.

Product dimensions are given throughout the product catalog and are followed by parenthesis which have the metric equivalent in millimeters.

Ordering Information

The most efficient way to enter an order is through Trendway On-Line Order Entry on dealer.trendway.com, which also accepts .sif files from the design software listed above. Faxed orders are available as well but may extend lead-times.

For ease in specifying, Trendway's catalog numbering system uses meaningful characters to convey description, surface type, and size. For example, PSLAT436 represents a Pack Four-High **L**ateral File that has **4** drawers and is **36"** (914)-wide.

Order specification examples are shown throughout the price book at the bottom of each page. Be sure to follow the order sequence carefully to ensure complete and accurate order specification.

After placing an order, Trendway will send an order acknowledgement that follows the sequence of information outlined below. Trendway encourages you to follow the same steps so that checking your order against the acknowledgement will be as easy as possible.

Placing an Order

To make placing an order simple, Trendway On-Line Order Entry automatically prompts the product and option decisions that are required. For accurate order processing on faxed orders, please type or use legible handwriting, and be sure to include the following information:

1. A complete "sold to" address with correct Zip code.
2. A complete "ship to" address with correct Zip code.
3. A purchase order number. (The order is issued to Trendway Corporation, Holland, Michigan.)
4. A signature or name of person authorizing the purchase order.
5. A contact name and phone number at your company.
6. An actual calendar date for the requested delivery date (not ASAP).
7. Line items that are complete, which means all catalog numbers and descriptions, options listed for each product selected, fabric/finish pattern and color descriptions, and all corresponding letter or number codes. Be sure to make a pick for all available options. Also, combine identical items and specify total quantity unless using special marking or tagging.

(Refer to your price list for ordering options.)
8. Special products referenced by their control numbers as well as their descriptions.
9. Line items that include price per unit, as well as extended totals.
10. A total dollar amount for the purchase order.
11. Any special shipping requirements clearly noted; i.e., "call before delivery."

By placing your orders correctly and completely the first time around, your order will be processed and scheduled without delay (subject to credit approval).

Lead-Times

The majority of Pack products are shipped within Trendway's standard lead time. Extended lead-time items in the catalog are designated by shading.

Note: Shipping lead-times are subject to product availability due to order size. For exact lead-times on your order contact Trendway Customer Care.

Product Questions, Quotes & Order Placement On-Line

dealer.trendway.com
Hours: 24 Hours, 7 Days a Week

Customer Care Representative

Hours: Monday-Friday
7:30 am to 5:30 pm EST
Phone: 1-800-893-8115
Fax: 1-800-893-8121
e-mail: customercare@trendway.com

Trendway Custom Solutions

Phone: 1-800-893-8117

For more information on Order Placement, Confirmation, and Lead-Times, see the Pricing, Procedures & Policies section in the back of the price book.

Sequence Information

The table below shows a sample of the price book format's sequence of information which will assist when placing an order and checking an order acknowledgement.

	Catalog Number	Pull Style	Trim Color	Lock
Sample Part Number:	PSLAT436	.L	.J	.R

Pack | Filing + Storage | Statement of Line

Freestanding Towers

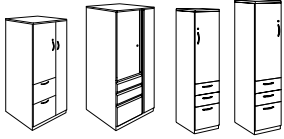

D W H
 23¹/₂" x 15¹/₄" x 39⁷/₈"
 23¹/₂" x 23¹/₂" x 39⁷/₈"
 23¹/₂" x 23¹/₂" x 49³/₄"
 23¹/₂" x 15¹/₄" x 51³/₈"
 23¹/₂" x 23¹/₂" x 51³/₈"
 23¹/₂" x 23¹/₂" x 57³/₄"
 23¹/₂" x 15¹/₄" x 65⁷/₈"
 23¹/₂" x 23¹/₂" x 65⁷/₈"

Tower with Bookcase

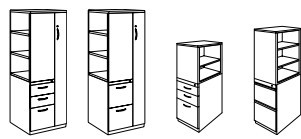

D W H
 23¹/₂" x 23¹/₂" x 49³/₄"
 23¹/₂" x 15¹/₄" x 51³/₈"
 23¹/₂" x 23¹/₂" x 51³/₈"
 23¹/₂" x 23¹/₂" x 57³/₄"
 23¹/₂" x 15¹/₄" x 65⁷/₈"
 23¹/₂" x 23¹/₂" x 65⁷/₈"

Mobile Towers

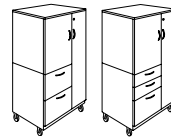

D W H
 23¹/₂" x 23¹/₂" x 43¹/₄"
 23¹/₂" x 23¹/₂" x 54³/₄"

Storage Lockers



D W H
 18" x 12" x 51³/₈"
 24" x 12" x 51³/₈"
 18" x 12" x 65⁷/₈"
 24" x 12" x 65⁷/₈"
 18" x 18" x 51³/₈"
 24" x 18" x 51³/₈"
 18" x 18" x 65⁷/₈"
 24" x 18" x 65⁷/₈"

Storage Lockers continued

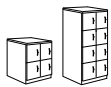

D W H
 18" x 12" x 65⁷/₈"
 18" x 12" x 65⁷/₈"



D W H
 24" x 18" x 65⁷/₈"



D W H
 18" x 18" x 34"
 18" x 18" x 65"

Laterals



D W H
 18¹/₄" x 30" x 28³/₈"
 18¹/₄" x 36" x 28³/₈"
 18¹/₄" x 42" x 28³/₈"



D W H
 18¹/₄" x 30" x 27⁹/₄"
 18¹/₄" x 36" x 27⁹/₄"
 18¹/₄" x 42" x 27⁹/₄"



D W H
 18¹/₄" x 30" x 39⁷/₈"
 18¹/₄" x 36" x 39⁷/₈"
 18¹/₄" x 42" x 39⁷/₈"



D W H
 18¹/₄" x 30" x 51³/₈"
 18¹/₄" x 36" x 51³/₈"
 18¹/₄" x 42" x 51³/₈"

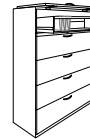

D W H
 18¹/₄" x 30" x 65⁷/₈"
 18¹/₄" x 36" x 65⁷/₈"
 18¹/₄" x 42" x 65⁷/₈"

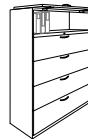

D W H
 18¹/₄" x 30" x 77³/₈"
 18¹/₄" x 36" x 77³/₈"
 18¹/₄" x 42" x 77³/₈"

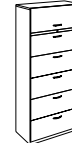

Laterals with Shelves



D W H
 18¹/₄" x 30" x 51³/₈"
 18¹/₄" x 36" x 51³/₈"
 18¹/₄" x 42" x 51³/₈"
 18¹/₄" x 30" x 65⁷/₈"
 18¹/₄" x 36" x 65⁷/₈"
 18¹/₄" x 42" x 65⁷/₈"



D W H
 18¹/₄" x 30" x 65⁷/₈"
 18¹/₄" x 36" x 65⁷/₈"
 18¹/₄" x 42" x 65⁷/₈"



D W H
 18¹/₄" x 30" x 77³/₈"
 18¹/₄" x 36" x 77³/₈"
 18¹/₄" x 42" x 77³/₈"

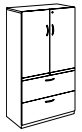

D W H
 18¹/₄" x 30" x 51³/₈"
 18¹/₄" x 36" x 51³/₈"
 18¹/₄" x 42" x 51³/₈"
 18¹/₄" x 30" x 65⁷/₈"
 18¹/₄" x 36" x 65⁷/₈"
 18¹/₄" x 42" x 65⁷/₈"

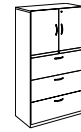

D W H
 18¹/₄" x 30" x 65⁷/₈"
 18¹/₄" x 36" x 65⁷/₈"
 18¹/₄" x 42" x 65⁷/₈"
 18¹/₄" x 30" x 77³/₈"
 18¹/₄" x 36" x 77³/₈"
 18¹/₄" x 42" x 77³/₈"

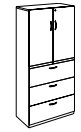

D W H
 18¹/₄" x 30" x 77³/₈"
 18¹/₄" x 36" x 77³/₈"
 18¹/₄" x 42" x 77³/₈"



Double Door Storage Cabinets



D W H
 18¹/₄" x 36" x 27³/₄"



D W H
 18¹/₄" x 30" x 28³/₈"
 18¹/₄" x 36" x 28³/₈"
 18¹/₄" x 42" x 28³/₈"

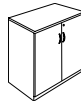

D W H
 18¹/₄" x 30" x 39⁷/₈"
 18¹/₄" x 36" x 39⁷/₈"
 18¹/₄" x 42" x 39⁷/₈"

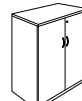

D W H
 18¹/₄" x 30" x 51³/₈"
 18¹/₄" x 36" x 51³/₈"
 18¹/₄" x 42" x 51³/₈"

Double Door Storage Cabinet

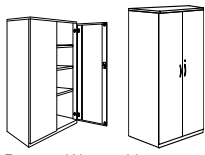

D W H
 18¹/₄" x 30" x 65⁷/₈"
 18¹/₄" x 36" x 65⁷/₈"
 18¹/₄" x 42" x 65⁷/₈"
 18¹/₄" x 30" x 77³/₈"
 18¹/₄" x 36" x 77³/₈"
 18¹/₄" x 42" x 77³/₈"

Wardrobe Cabinet

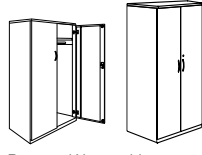

D W H
 18¹/₄" x 36" x 65⁷/₈"
 18¹/₄" x 36" x 77³/₈"

Pedestal File Center

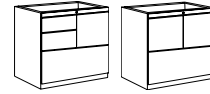

D W H
 18" x 30" x 27"

Freestanding Pedestals

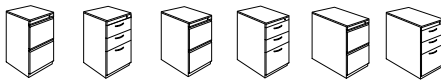

D W H
 18⁷/₈" x 15¹/₄" x 27³/₄"
 21⁷/₈" x 15¹/₄" x 27³/₄"
 27⁷/₈" x 15¹/₄" x 27³/₄"

Mobile Pedestals



D W H
 18⁷/₈" x 15¹/₄" x 27³/₄"
 21⁷/₈" x 15¹/₄" x 27³/₄"
 27⁷/₈" x 15¹/₄" x 27³/₄"

Work Surface Supporting Pedestals



D W H
 21⁷/₈" x 15¹/₄" x 27³/₄"

D W H
 17⁷/₈" x 15¹/₄" x 19³/₈"
 21⁷/₈" x 15¹/₄" x 19³/₈"

Bookcases



D W H
 13³/₈" x 30" x 27³/₄"
 13³/₈" x 36" x 27³/₄"
 13³/₈" x 42" x 27³/₄"



D W H
 13³/₈" x 30" x 39⁷/₈"
 13³/₈" x 36" x 39⁷/₈"
 13³/₈" x 42" x 39⁷/₈"

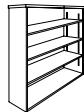

D W H
 13³/₈" x 30" x 51³/₈"
 13³/₈" x 36" x 51³/₈"
 13³/₈" x 42" x 51³/₈"



D W H
 13³/₈" x 30" x 65⁷/₈"
 13³/₈" x 36" x 65⁷/₈"
 13³/₈" x 42" x 65⁷/₈"
 13³/₈" x 30" x 70"
 13³/₈" x 36" x 70"
 13³/₈" x 42" x 70"



D W H
 13³/₈" x 30" x 77¹/₈"
 13³/₈" x 36" x 77¹/₈"
 13³/₈" x 42" x 77¹/₈"

Mobile Bookcase



D W H
 15¹/₄" x 32¹/₂" x 26¹/₂"

Surface Material Program

The Trendway Surface Material Program includes a broad selection of coordinated fabrics, laminate and trim finish options. Additionally, Trendway offers a Customers Own Material (COM) program to allow customers to further personalize their work stations.

The following sections describe the Trendway Surface Materials vocabulary.

Standard Program

Trendway's Standard Program of timeless and popular fabrics, finishes, vinyls and laminates, is recommended for corporate standards programs. These fabrics are carded and swatched by Trendway. Materials in the Trendway Standard Program offering are readily available for orders to ship within 2-4 weeks. Refer to individual panels for fire rating classifications.

Scheduled Program

Trendway's Schedule Program is made up of additional colors of standard patterns, as well as an evolving collection of fabrics from our textile partners designed to solve all your needs. Influenced and kept up to date by emerging trends, the typical life span in this program is one to three years and is not considered part of the standard program. To see the Scheduled fabrics go to the the surface material page on our website at www.Trendway.com and filter for "Scheduled" under "Lead-Times". Scheduled fabrics may have different lead time than standard fabrics. Please call Trendway customer care for estimated ship dates.

Both Standard and Scheduled Materials in this program comply with the industry standards for quality and performance.

They all pass California Technical Bulletin 117-2013 and are listed as part of the UL recognized component program.

Terratex®

Terratex is a Duvaltex brand designating fabrics that are made from 100% recycled or compostable material using increasingly sustainable manufacturing practices to produce a high-quality product that is recyclable at the end of its useful life. For more information, go to www.terratex.com.

COM

Customers Own Material program allows customers to select and specify their own fabric or laminate on Trendway product. For detailed information see item #11 (COM) in the Pricing, Procedures and Policies section in the back of the price list or on Trenddealer.com.

Pre-Approved COM

Select from popular COM fabrics pre-approved by Trendway. Customers are able to search the COM library on dealer.trendway.com for fabrics and specific applications that have passed manufacturability testing on Trendway product.

HOW TO ORDER SAMPLES**Standard Program Binder Cards**

Seating and panel binder cards are available through Trendway fulfillment. dealer.trendway.com

Standard Program Samples

Samples of fabrics and finishes are available through Trendway fulfillment. dealer.trendway.com

Scheduled Samples

Samples must be ordered directly through the supplier. Contact information is listed below and also on our website www.trendway.com/surfacematerials. Click on the link next to the swatch samples.

Camira

www.camirafabrics.com
1-616-288-0655

Culp Contract

www.culpcontract.com
336-888-6274

Guilford Of Maine®

www.guilfordofmaine.com
1-800-544-0200

Mayer Fabrics

www.mayerfabrics.com
1-800-428-4415

Momentum® Textiles

www.memosamples.com
1-800-366-6839

Nevamar

www.nevamar.com
1-800-638-4380

Pionite

www.pionite.com
1-800-746-6483

Ultrafabrics®

www.ultrafabricsinc.com
914-460-1730

Wilsonart®

www.wilsonart.com
1-800-433-3222

Surface Material Legend

 = 100% Recycled Content

 = Bleach Cleanable. Refer to specific cleaning instructions for each fabric on www.Trendway.com.

Pattern	Capture Tiles	Choices Panels & All Systems Components	Fabric Screens	Tackboards		TrendWall	Volo	Cushion Tops
				> 60"	< 60"			
Amaze	↓	↓	↓	R	↓	↓	↓	•
Anchorage	↓	↓	↓	R	↓	•	↓	•
Aurora	↓	↓	↓	R	↓	↓	↓	•
Chase	↓	↓	↓	R	↓	↓	↓	•
Framework	↕	↕	↕	↕	↕	•	↕	•
Glint	↓	↓	↓	R	↓	↓	↓	•
Intermix	↓	↓	•	R	↓	↓	↓	•
Intuition*	↓	•	•	R	↓	•	↓	↓
Merge	↕	↕	↕	↕	↕	↕	↕	↕
Mingle	↓	↓	↓	R	↓	•	•	•
Netiquette	↓	•	•	R	↓	↓	↓	•
Pact	↓	↓	↓	R	↓	↓	↓	•
Pursuit	↓	↓	↓	R	↓	↓	↓	•
Tabby Weave	↕	↕	↕	↕	↕	↕	↕	•

- Not Available
- ↕ Non Directional - Pattern will be applied for best yield
- ↓ Down Roll - The height dimension of the tile or component is parallel to the warp of the fabric
- R Railroaded - The height dimension of the tile or component is perpendicular to the warp of the fabric
- * Multi-use fabric (seating and panel) available on Capture, Fabric Screens, and Volo
- ** Not available on Choices Panels, but approved on Choice's Tackboards and Flipper Doors

Down-Roll (↓)

Down-roll means the height dimension of the tile or component is parallel to the warp of the fabric (Fig. A).

Fig. A

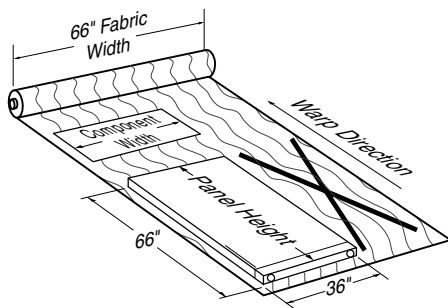

Railroad

Railroad means the height dimension of the tile or component is perpendicular to the warp of the fabric (Fig. B).

Fig. B

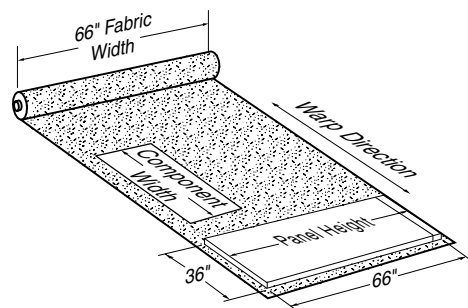

COM Fabrics

COM fabrics may be applied either Down-roll (Fig. A) or Railroad (Fig. B). When choosing Railroad on COM fabrics please note that 84" (2134)-high Choices and TrendWall Panels cannot be Railroad due to panel fabric being 66" (1676)-wide (Fig. C).

Fig. C

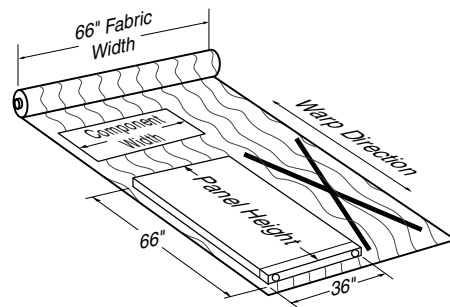

Standard Systems Finishes

Trendway standard paints include smooth and textured styles in our six trim colors.

Systems Paints and Trim

K	Charcoal
DW	Designer White
G	Gray
L	Light Gray
Y	Sand
J	Stucco
TK	Textured Charcoal
TDW	Textured Designer White
TG	Textured Gray
TL	Textured Light Gray
TY	Textured Sand
TJ	Textured Stucco

Glazed Panels

Plexiglass

01	Clear
E3A	*Frosted

*Tempered Glass

03	Clear
05	Frosted

Ecoresin

The color options are semi-transparent with (or without) patterns.

*3form

E02	Solo Aqua Supermatte Ecoresin
E01	Solo Supermatte Ecoresin
E03	Spider Ecoresin

***Note:** These options are offered at an upcharge. Please refer to a specific item in your price list to determine the amount of upcharge.

Premium Systems Finishes

Premium finishes are offered at a modest upcharge. Please refer to a specific item in your price list to determine the amount of upcharge. Textured colors display a matte texture with metallic highlights. They coordinate with standard Trendway trim colors (indicated by the second letter in the code).

Smooth Metallic Paint

PA	Platinum
----	----------

Standard Vinyl Edgeband

Solid

K	Charcoal
E1	Designer White
E6	Graphite
L	Light Gray
Y	Sand
E7	Shadow
J	Stucco

Patterned

E8	Casual Linen
E9	Classic Linen
EB	Crisp Linen
EG	Earthen Twill
EH	Graphite Twill
EE	Sarum Twill

Woodgrain

W8	Beigewood
WE	Brazilwood
W7	Empire Mahogany
ER	Espresso Pearwood
WY	Finnish Oak
W5	Fusion Maple
E5	Phantom Charcoal
E4	Phantom Ecru
E3	Phantom Pearl
WZ	Walnut
W6	Wild Cherry

** Available on Capture, Fabric Screens, and Volo*

To see all Trendway finish options, go to Trendway.com

High Pressure Laminates – for Work Surfaces and Laminate Tiles

Standard Program

Grade 1

Solid

583	Charcoal
J0C	Designer White
J9D	Graphite
573	Light Gray
J20	Sand
J04	Shadow
J11	Stucco

Pattern

J6B	Casual Linen
J6A	Classic Linen
J69	Crisp Linen
J9H	Earthen Twill
JM4	Evening Tigris
J9J	Graphite Twill
JN2	Grey Tigris
J09	White Tigris
J9G	Sarum Twill

Woodgrain

J0G	Beigewood
J0D	Brazilwood
J2A	Empire Mahogany
J9X	Espresso Pearwood
J98	Finnish Oak
J25	Fusion Maple
J99	Walnut
J1R	Wild Cherry

Grade 2

Woodgrain

J9C	Phantom Charcoal
J9B	Phantom Ecu
J9A	Phantom Pearl

Thermofused Laminates – for Storage and Laminate Tiles

Standard Program

Solid

XZ4	Black
XZH	Designer White

Grade 1

Woodgrain

XZ8	Beigewood
XZE	Brazilwood
XZ3	Empire Mahogany
XY6	Espresso Pearwood
XYZ	Finnish Oak
XZ2	Fusion Maple
XZZ	Walnut
XZ1	Wild Cherry

Grade 1

Woodgrain

XY2	Phantom Charcoal
XY1	Phantom Ecu
XY0	Phantom Pearl

Grade 2

CROSS REFERENCE

High Pressure Laminate (HPL), Thermofused Laminate (TFL), Edgebanding, Wood Veneer, Panel Vinyl

Solid Color Name	HPL Capture, Choices, Pack, Worksurfaces	TFL Capture, Intrinsic, Trig	Edgeband	Finish Code	Panel Vinyl Choices, TrendWall, Volo
Black		XZ4			
Charcoal**	583		K	K	V39
Designer White**	J0C	XZH	E1	DW	V52
Graphite	J9D		E6		
Gray**				G	V38
Light Gray**	573		L	L	V51
Platinum**				PA	V53
Sand**	J20		Y	Y	V48
Shadow	J04		E7		
Stucco**	J11		J	J	V49

Pattern Color Name	HPL Capture, Choices, Pack, Worksurfaces	Edgeband
Casual Linen	J6B	E8
Classic Linen	J6A	E9
Crisp Linen	J69	EB
Earthen Twill	J9H	EG
Graphite Twill	J9J	EH
Sarum Twill	J9G	EE

Woodgrain Pattern Name	HPL Capture, Choices, Pack, Worksurfaces	TFL Capture, Intrinsic, Trig	Edgeband	Wood Veneer Choices, Volo	Panel Vinyl TrendWall
American Natural					AS2
Beigewood	J0G	XZ8	W8	M4	
Brazilwood	J0D	XZE	WE	M5	
Empire Mahogany		XZ3	W7	M8	
Espresso Pearwood	J9X	XY6	ER		
Finnish Oak	J98	XZY	WY		
Fusion Maple	J25	XZ2	W5	M2	
Phantom Charcoal	J9C	XY2			
Phantom Ecru	J9B	XY1	E4		
Phantom Pearl	J9A	XY0	E3		
Russian Maple					AS3
Sorrel Pear					AS4
Walnut	J99	XZZ	WZ		
Wild Cherry	J1R	XZ1	W6	M9	

** Trendway standard trim paint color

To see all Trendway finish options, go to [Trendway.com](https://www.trendway.com)

This form can be used as a worksheet or an order form to determine what key alike Pack Core/Key Sets are needed for key-alike Pack filing and storage, Pack locks on Choices flipper units and for additional Pack Lock Keys, Core Keys and Master Keys*. It is also used to specify special tagging instructions to designate installation locations, which is offered free of charge.

The information on this form can either be entered in Trendway's design software, or through Trendway On-line Order Entry on Trenddealer.com using the catalog numbers listed below or it can be used as an order form and faxed to Trendway Customer Care.

Pack Core/Key Set

The Pack Core/Key Set is needed when the Key Alike Option 'T' is selected, or if a lock needs to be changed out in an existing unit. The Core/Key Set provides the ability to pick the key number for a single storage piece, each individual office or group of offices. Pack Core/Key Sets includes a lock core and 2 lock keys. Additional lock keys are available.

Pack Core Installation/Removal Key

Pack Core Installation/Removal Key is needed to install Core/Key Sets and to remove or replace existing Pack lock cores.

*Pack Master Key

Pack Master Key is used to open any Pack style lock. Master keys are sent out separately from the product order. Request for Master keys must be made on the end users letterhead and faxed to Trendway Customer Care at 1-800-893-8212. Orders are shipped within 24-hours of receipt.

Pack Keying Order Form

Trendway Corporation
13467 Quincy St. Holland MI 49424
Phone: (800) 893-8115 Fax: (800) 893-8121
www.trendway.com

Customer P.O. Number _____ Trendway Order Number _____
Ship To address if different from P.O. _____

Pack Core/Key Set – PLCAK (Pack Lock Cores are Silver in color)

Qty.	List Price \$14	Key Number S101-S200	Floor		Office	Key—Alike Special Tagging Instructions
2	\$28	0	3	5		John's Office
6	\$84	0	2			Offices 201, 252

SAMPLE

Additional Pack Lock Key(s) – PLKS

Qty.	List Price \$8	Key Number S101-S200	Floor		Office	Key—Alike Special Tagging Instructions
1	\$8	S101				

Additional Pack Core Installation/Removal Key(s) - CRK

Qty.	List Price \$4
3	\$12

Pack Master Key(s)
Pack Master Keys are used to open any Pack style lock. Master keys are sent separately from the product order. Requests for Master keys must be made on the end-user's letterhead and faxed to Trendway Customer Care at 1-800-893-8121. Orders are shipped within 24 hours of receipt.



Trendway Corporation
13467 Quincy St. Holland MI 49424
Phone: (800) 893-8115 Fax: (800) 893-8121
www.trendway.com

Pack Keying Order Form

Customer P.O. Number _____ Trendway Order Number _____
Ship To address if different from P.O. _____

Pack Core/Key Set – PLCAK (Pack Lock Cores are Silver in color)

Qty.	List Price \$14	Key Number S101-S200	Key—Alike Special Tagging Instructions		
			Floor	Office	

Additional Pack Lock Key(s) – PLKS

Qty.	List Price \$8	Key Number S101-S200	Key—Alike Special Tagging Instructions		
			Floor	Office	

Additional Pack Core Installation/Removal Key(s) - CRK

Qty.	List Price \$4	

Pack Master Key(s)

Pack Master Keys are used to open any Pack style lock. Master keys are sent separately from the product order. Requests for Master keys must be made on the end-user's letterhead and faxed to Trendway Customer Care at 1-800-893-8121. Orders are shipped within 24 hours of receipt.

Pack Core/Key Set

The Pack Core/Key Set must be ordered when the Key-Alike lock option is chosen to replace the “disposable” core that ships with Pack filing units in order for these units to lock. This set can also be ordered to replace an existing Pack Core/Key Set. The set includes a Pack lock core and 2 lock keys.

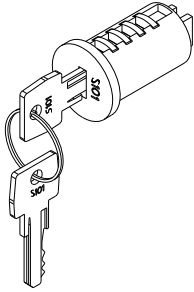

Pack Core Installation/Removal Key

The Pack Core Installation/Removal Key is needed to install or remove Pack Cores in Pack filing units or in Pack Locks for Choices Flipper Units (PKCHFLA and PKCTAFLA).

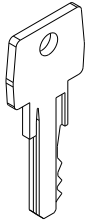

Pack Keys

Replacement Pack keys are available for order.

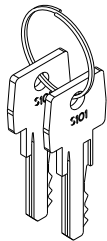

Pack Core/ Key Sets

	List Price	Catalog Number	Key Number
	\$15	PLCAK	S101-S200

Pack Core Installation/Removal Key

	List Price	Catalog Number	
	\$4	CRK	

Pack Lock Keys

	List Price	Catalog Number	Key Number
	\$8	PLKS	S101-S200

Build your complete Part Number here:

_____	_____
-------	-------

Sample Part Number:

PLKS	__
------	----

Total Cost \$8 =

\$8	+	N/C
-----	---	-----

Finishes

All Pack filing and storage units, including door and drawer fronts, are painted metal and are available in a variety of finishes.

Pull Style Options

Pack filing units have two pull style options, a bevel pull and an applied pull. The applied pull has three 128mm center pull hardware options to choose from: Classic, Streamline and Designer. These are all plated nickel finish.

Bevel

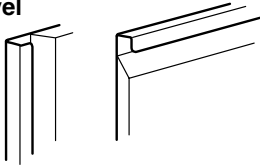

Applied

Note: Applied Pulls (Classic, Streamline, Designer and Mod2) add up to 1 1/8" (29) to the depth of the file unit.

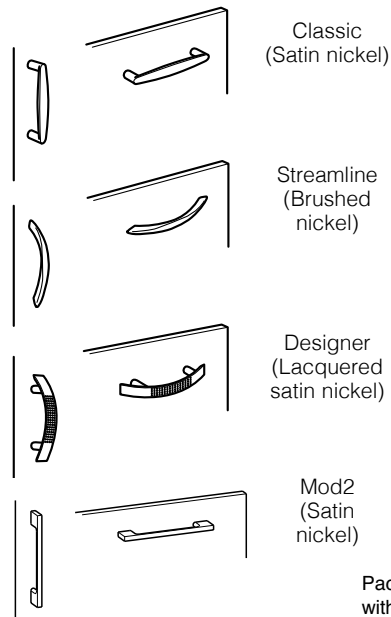

Casters

Black standard casters are included, two (2) locking and two (2) non-locking on each unit.

Specifications

All dimensions are nominal unless otherwise noted.

Keyed Alike

Pack filing and storage units have two lock options to choose from. Units can be randomly keyed (option "R") or they can be key-alike (option "T") for no additional upcharge. When the randomly keyed option "R" is chosen the Pack filing and storage unit will ship with a randomly numbered core/key.

When the key-alike lock option "T" is chosen the Pack filing unit will ship with a "disposable" core in place of the core/key and the specified Pack Core/Key set(s) will be packaged separately for field installation. The "disposable" core must be field replaced with a Pack Core/Key set in order for the Pack filing unit to lock. The Core/Key set (PLCAK) must be ordered separately.

Load Capacities

All Pack filing units meet or exceed the applicable load requirements. For a complete listing of load capacities, contact Trendway Customer Care or visit trenddealer.com

Pedestal Drawers:

- 3" (76) Pedestal Drawer — 10 lbs. (4.5kg)
- 6" (152) Pedestal Drawer — 20 lbs. (9kg)
- 12" (305) Pedestal Drawer — 40 lbs. (18kg)

Lateral File and File Center Lateral Drawers:

2 lbs. (.9kg) per linear inch of usable space

Bookcases:

- 30" (762) shelf — 70 lbs. (32kg)
- 36" (914) shelf — 85 lbs. (39kg)
- 42" (1067) shelf — 100 lbs. (45kg)

Lockers:

- 12" wide — 35 lbs. (16kg)
- 18" wide — 55 lbs. (25kg)

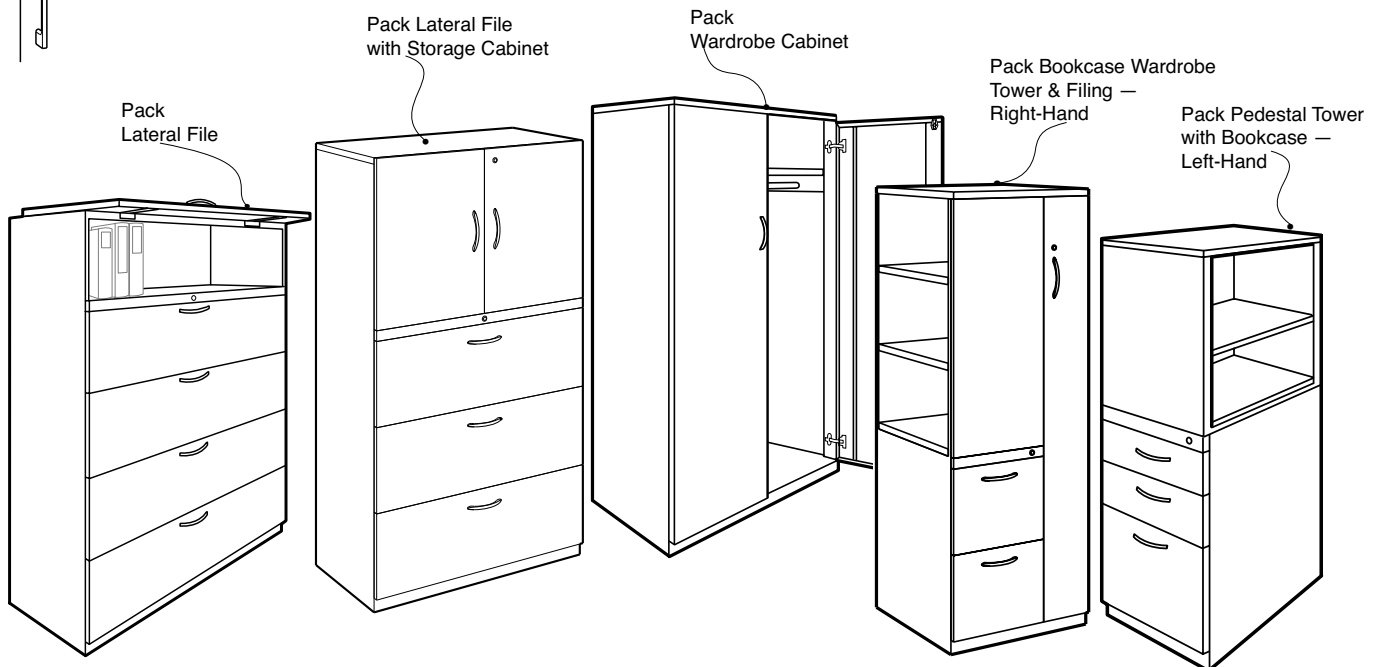

Double-Door and Wardrobe:

30" (762) shelf — 90 lbs. (41kg)
 36" (914) shelf — 105 lbs. (48kg)
 42" (1067) shelf — 125 lbs. (57kg)
 Wardrobe Bar

Storage Tower:

3 lbs. (1.4kg) per linear inch

Maximum Load Capacity For Any Steel Storage Unit

The maximum load capacity for any storage unit is calculated by multiplying the above stated lbs. for each shelf or drawer that is included with the unit and adding them together (includes the top of the unit and the inside bottom).

Eg: Maximum load capacity for a PSBC336 =
 unit bottom + 2 shelves + unit top at 3 lbs.
 per linear inch = 36"
 (914) linear in. per shelf x 4 = 432
 lbs. maximum load

Note: The addition of more shelves does not increase the maximum amount a unit can be loaded.

Proper Usage

Pedestals and File Centers

Any pedestal or file center that is attached to the underside of a work surface must have glides adjusted to support the weight of the pedestal or file center.

Lateral Files

CAUTION: Any freestanding lateral file, if improperly used or loaded, can tip. Since files may contain significant weight, this tipping can result in serious damage and/or personal injury. For proper and safe performance, read and follow instructions provided with each file.

Do not attempt to open more than one lateral file drawer at a time. Do not use drawers as steps. Failure to follow these instructions may cause tipping of cabinet, resulting in personal injury.

Use counterbalance weights when-ever lateral files or pedestals are not anchored or ganged back-to-back. Side-by-side ganging does not improve stability.

To avoid tipping, always load bottom drawers before loading top drawer.

Glide Adjustment Ranges

Pack Pedestal and Pedestal Tower	1 5/8" (41)
Pack Lateral	1 1/4" (32)
Pack Storage Tower	7/8" (22)
Pack Bookcases	5/8" (16)
Pack File Centers	1 1/4" (32)
Pack Double-Door and Wardrobe	7/8" (22)
Pack Lockers	7/8" (22)

Ordering Information

For ease in specifying, Trendway's catalog numbering system uses meaningful characters to convey description, surface type, and size. For example, PSLAT530 represents a **P**ack **S**torage **L**ATeral **5**-High by **30"** (762) -wide.

Trendway has further simplified the order process by having all the options available for a product listed in the price chart. By following the Sample Part Number Example at the bottom of each page, you create a Part Number for each product. This Part Number will match your acknowledgement and packing slip.

When ordering filing and storage units, list the following:

- Quantity (combine same products)
- Complete Part Number (see Sample Part Number at the bottom of each page for correct number sequence).
- For ease of reading, place a period between each option number (PSP1212.B.TL).

Sample Part Number:	Catalog Number	Pull Style	Trim Color
PSP1212	.B	.TL	
Total Cost \$620 =	\$620	+ N/C	+ N/C

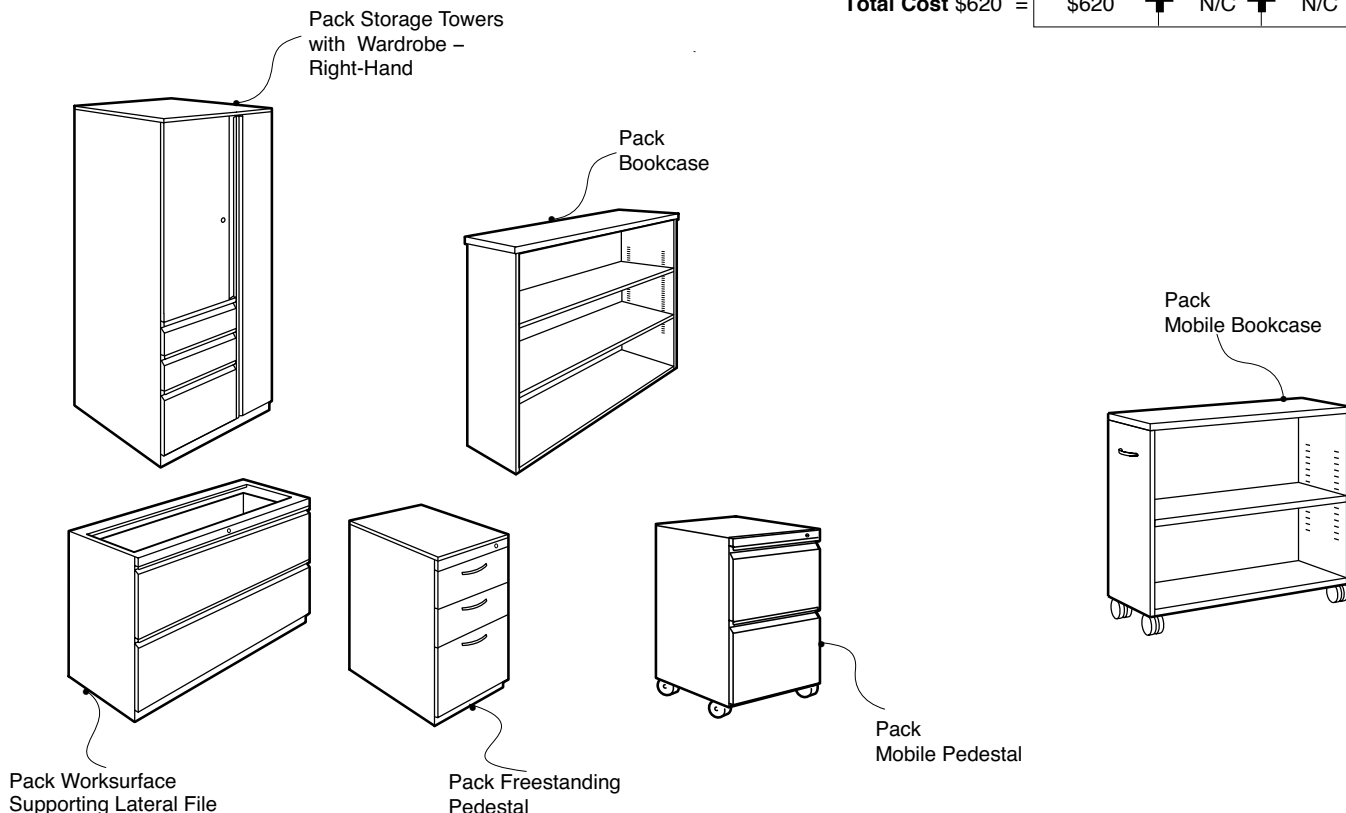

Inside Locker Dimensions

Locker Type	Description	Inner Depth (in.)	Inner Width (in.)	Inner Height (in.)
Single Locker - 12" Wide	Above shelf in 18" x 51 ³ / ₈ " locker	17.41	9.83	12
	Below coat rod in 18" x 51 ³ / ₈ " locker	17.41	9.83	31.74
	Above shelf in 24" x 51 ³ / ₈ " locker	22.66	9.83	12
	Below coat rod in 24" x 51 ³ / ₈ " locker	22.66	9.83	31.74
Single Locker - 18" Wide	Above shelf in 18" x 65 ⁷ / ₈ " locker	17.41	9.83	12
	Below coat rod in 18" x 65 ⁷ / ₈ " locker	17.41	9.83	46.24
	Above shelf in 24" x 65 ⁷ / ₈ " locker	22.66	9.83	12
	Below coat rod in 24" x 65 ⁷ / ₈ " locker	22.66	9.83	46.24
Single Locker - 18" Wide	Above shelf in 18" x 51 ³ / ₈ " locker	17.41	15.83	12
	Below coat rod in 18" x 51 ³ / ₈ " locker	17.41	15.83	31.74
	Above shelf in 24" x 51 ³ / ₈ " locker	22.66	15.83	12
	Below coat rod in 24" x 51 ³ / ₈ " locker	22.66	15.83	31.74
Single Locker - 18" Wide	Above shelf in 18" x 65 ⁷ / ₈ " locker	17.41	15.83	12
	Below coat rod in 18" x 65 ⁷ / ₈ " locker	17.41	15.83	46.24
	Above shelf in 24" x 65 ⁷ / ₈ " locker	22.66	15.83	12
	Below coat rod in 24" x 65 ⁷ / ₈ " locker	22.66	15.83	46.24
Double Locker - 12" Wide	Top Locker	22.66	9.83	29.64
	Bottom Locker	22.66	9.83	30.72
Double Locker - 18" Wide	Top Locker	22.66	15.83	29.64
	Bottom Locker	22.66	15.83	30.72
Quad Locker	Top Locker	17.41	9.83	29.64
	Bottom Locker	17.41	9.83	30.72
Cubby Locker	Inside Cubby Dimension	17.41	9.83	13.985

Single Locker 12"

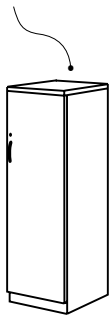

Right Hand Shown

Double Locker 18"

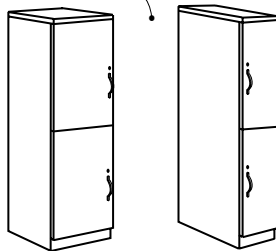

Left Hand Shown

Right Hand Shown

Quad Locker

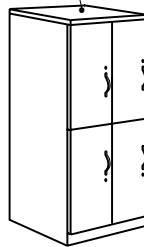

Left Hand Shown

Cubby Locker

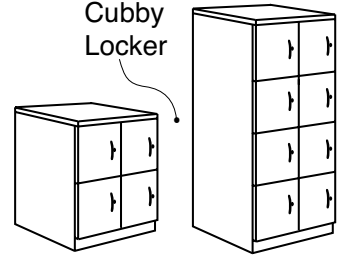

34 ³/₄" High

65 ⁷/₈" High

Left Hand Shown

Pack Storage Tower

The Pack Storage Tower provides coat, drawer, and cupboard storage in a single freestanding cabinet. The Tower is constructed of painted metal, has 7/8" adjustable leveling glides, and is available in a Right-Hand version (wardrobe on the right side) or a Left-Hand version (wardrobe on the left side). Towers are available with five pull options, including four applied pulls and a bevel pull extending the length of the door or drawer.

The cupboard unit includes adjustable painted metal shelves. Pedestal drawers have painted metal drawer fronts and full extension ball-bearing slides. The drawers and doors have one common lock. The wardrobe includes one coat rod.

Available accessories include Pack Pedestal Divider/Conversion Kit(PCD), Pack Pencil Tray (HPPT), Lateral File Dividers (LFDE) and Shelf/File Dividers (SFDIV).

When the key-alike lock option "T" is chosen a "disposable" core is assembled in the filing unit to temporarily secure the drawers and doors for transit. The "disposable" cores must be field replaced with Pack Core/Key Sets in order for the Pack filing unit to lock. Core/Key Sets (PLCAK) must be ordered separately or by using the keying order form.

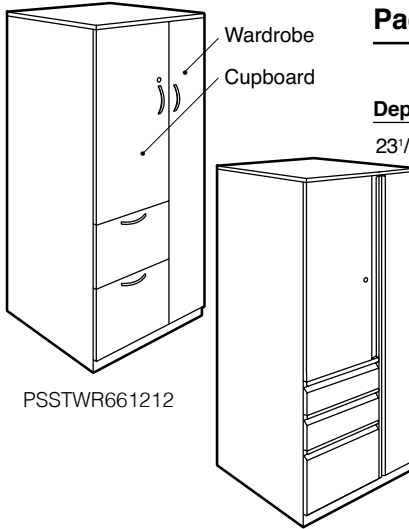

Wardrobe
Cupboard

PSSTWR661212

PSSTWR666612

Pack Storage Tower – Right-Hand

Depth	Dimensions Width	Height	No. of Shelves	List Price	Catalog Number	Pull Style	Trim Color	Lock
23 ¹ / ₂ " (597)	23 ¹ / ₂ " (597)	39 ⁷ / ₈ " (1013)	1	\$2170	PSSTWR401212	No Cost Bevel B	Standard Finishes No Cost	R No Cost Random
			1	2185	PSSTWR406612			
49 ³ / ₄ " (1264)	23 ¹ / ₂ " (597)	39 ⁷ / ₈ " (1013)	1	2162	PSSTWR501212	Applied L Classic	Premium Finishes + \$141	*T Deduct \$-15 Key-Alike
			1	2325	PSSTWR506612			
			1	2258	PSSTWR50121212			
51 ³ / ₈ " (1305)	23 ¹ / ₂ " (597)	39 ⁷ / ₈ " (1013)	1	2235	PSSTWR521212	E Stream- line	See Surface Materials Page 6	*Note: Be sure to order Core/ Key Sets (PLCAK) sep- arately (1 per unit)
			1	2318	PSSTWR526612			
			1	2385	PSSTWR52121212			
57 ³ / ₄ " (1467)	23 ¹ / ₂ " (597)	39 ⁷ / ₈ " (1013)	2	2314	PSSTWR581212	AZ Designer		
			2	2486	PSSTWR586612			
			2	2399	PSSTWR58121212			
65 ⁷ / ₈ " (1673)	23 ¹ / ₂ " (597)	39 ⁷ / ₈ " (1013)	2	2393	PSSTWR661212	MM Mod2		
			2	2479	PSSTWR666612			
			2	2923	PSSTWR66121212			

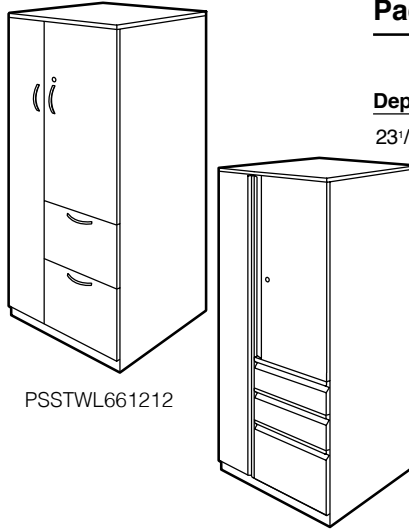

PSSTWL661212

PSSTWL666612

Pack Storage Tower – Left-Hand

Depth	Dimensions Width	Height	No. of Shelves	List Price	Catalog Number	Pull Style	Trim Color	Lock
23 ¹ / ₂ " (597)	23 ¹ / ₂ " (597)	39 ⁷ / ₈ " (1013)	1	\$2170	PSSTWL401212	No Cost Bevel B	Standard Finishes No Cost	R No Cost Random
			1	2185	PSSTWL406612			
49 ³ / ₄ " (1264)	23 ¹ / ₂ " (597)	39 ⁷ / ₈ " (1013)	1	2162	PSSTWL501212	Applied L Classic	Premium Finishes + \$141	*T Deduct \$-15 Key-Alike
			1	2325	PSSTWL506612			
			1	2258	PSSTWL50121212			
51 ³ / ₈ " (1305)	23 ¹ / ₂ " (597)	39 ⁷ / ₈ " (1013)	1	2235	PSSTWL521212	E Stream- line	See Surface Materials Page 6	*Note: Be sure to order Core/ Key Sets (PLCAK) sep- arately (1 per unit)
			1	2318	PSSTWL526612			
			1	2385	PSSTWL52121212			
57 ³ / ₄ " (1467)	23 ¹ / ₂ " (597)	39 ⁷ / ₈ " (1013)	2	2314	PSSTWL581212	AZ Designer		
			2	2486	PSSTWL586612			
			2	2399	PSSTWL58121212			
65 ⁷ / ₈ " (1673)	23 ¹ / ₂ " (597)	39 ⁷ / ₈ " (1013)	2	2393	PSSTWL661212	MM Mod2		
			2	2479	PSSTWL666612			
			2	2923	PSSTWL66121212			

Build your complete Part Number here: _____

Sample Part Number:

PSSTWR661212	.B	.J	.R
_____	—	—	—

Total Cost \$2393 =

\$2393	N/C	+	N/C	+	N/C
--------	-----	---	-----	---	-----

Pack Mobile Wardrobe Tower

The Pack Mobile Wardrobe Tower provides coat, drawer, and cupboard storage in a single mobile cabinet. The Tower is constructed of painted metal, has four casters, and is available in a Right-Hand version (wardrobe on the right side) or a Left-Hand version (wardrobe on the left side). Black standard casters included, two (2) locking and two (2) non-locking. Towers are available with five pull options, including four applied pulls and a bevel pull extending the length of the door or drawer.

The cupboard unit includes adjustable painted metal shelves. Pedestal drawers have painted metal drawer fronts and full extension ball-bearing slides. The drawers and doors have one common lock.

Available accessories include Pack Pedestal Divider/Conversion Kit(PCD), Pack Pencil Tray (HPPT), Lateral File Dividers (LFDE) and Shelf/File Dividers (SFDIV).

When the key-alike lock option "T" is chosen a "disposable" core is assembled in the filing unit to temporarily secure the drawers and doors for transit. The "disposable" cores must be field replaced with Pack Core/Key Sets in order for the Pack filing unit to lock. Core/Key Sets (PLCAK) must be ordered separately or by using the keying order form.

Pack Mobile Wardrobe Tower – Right-Hand

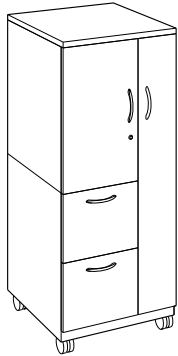

PSMSTWR561212

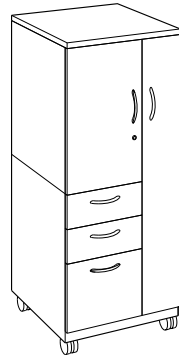

PSMSTWR566612

Depth	Dimensions Width	Height	No. of Shelves	List Price	Catalog Number	Pull Style	Casters	Trim Color	Lock
23 ¹ / ₂ " (597)	23 ¹ / ₂ " (597)	43 ¹ / ₄ " (1099)	1	\$2632	PSMSTWR441212	No Cost Bevel B	No Cost BL Black	Standard Finishes No Cost	R No Cost Random
		54 ³ / ₄ " (1391)	1	2666	PSMSTWR561212	Applied L Classic		Premium Finishes + \$141	*T Deduct \$-15 Key-Alike
		54 ³ / ₄ " (1391)	1	2734	PSMSTWR566612	E Stream- line AZ Designer MM Mod2		See Surface Materials Page 6	*Note: Be sure to order Core/ Key Sets (PLCAK) sep- arately (1 per unit)

Pack Mobile Wardrobe Tower – Left-Hand

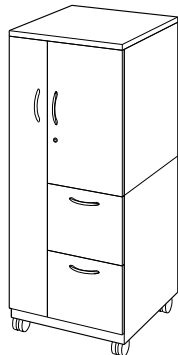

PSMSTWL561212

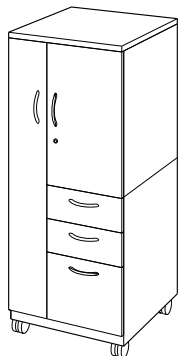

PSMSTWL566612

Depth	Dimensions Width	Height	No. of Shelves	List Price	Catalog Number
23 ¹ / ₂ " (597)	23 ¹ / ₂ " (597)	43 ¹ / ₄ " (1099)	1	\$2632	PSMSTWL441212
		54 ³ / ₄ " (1391)	1	2666	PSMSTWL561212
		54 ³ / ₄ " (1391)	1	2734	PSMSTWL566612

Build your complete Part Number here:

---	-	-	-	-
-----	---	---	---	---

Sample Part Number:

PSMSTWR561212	.B	.BL	.J	.R
-----	-	--	-	-

Total Cost \$2666 =

\$2666	+	N/C	+	N/C	+	N/C	+	N/C
--------	---	-----	---	-----	---	-----	---	-----

PACK SINGLE TOWERS

The Pack Single Tower includes a cupboard and pedestal drawers. The tower is constructed of painted metal and has 7/8" adjustable leveling glides. It is available in right- and left-hand (hinge on right) (hinge on left) versions. Pedestal drawers have full-extension ball-bearing slides. The tower is available with five pull options, including four applied pulls and a bevel pull extending the length of the door or drawers. Drawers and doors have one common lock. Cupboard shelves adjust in 1-1/2" increments.

Available accessories include Lateral File Dividers (LFDE), Shelf/File Dividers (SFDIV) and Label Holders (ZLHA).

When the key-alike lock option "T" is chosen a "disposable" core is assembled in the filing unit to temporarily secure the drawers and doors for transit. The "disposable" cores must be field replaced with Pack Core/Key Sets in order for the Pack filing unit to lock. Core/Key Sets (PLCAK) must be ordered separately or by using the keying order form.

		Pack Single Tower, Right Hand							
Depth	Dimensions		No. of Shelves	List Price	Catalog Number	Pull Style	Trim Color	Lock	
	Width	Height							
23 1/2" (597)	15 1/4" (387)	51 3/8" (1305)	1	\$1654	PSTR521212	No Cost Bevel B Applied L Classic E Streamline AZ Designer MM Mod2	Standard Finishes No Cost Premium Finishes + \$141 See Surface Materials Page 6	R No Cost Random *T Deduct \$-15 Key-Alike *Note: Be sure to order Core/Key Sets (PLCAK) separately (1 per unit)	
		51 3/8" (1305)	1	1817	PSTR526612				
	65 7/8" (1673)	2	1742	PSTR661212					
	65 7/8" (1673)	2	1905	PSTR666612					
		Pack Single Tower, Left Hand							
Depth	Dimensions		No. of Shelves	List Price	Catalog Number				
	Width	Height							
23 1/2" (597)	15 1/4" (387)	51 3/8" (1305)	1	\$1654	PSTL521212				
		51 3/8" (1305)	1	1817	PSTL526612				
	65 7/8" (1673)	2	1742	PSTL661212					
	65 7/8" (1673)	2	1905	PSTL666612					
Build your complete Part Number here:						-----	-	-	-

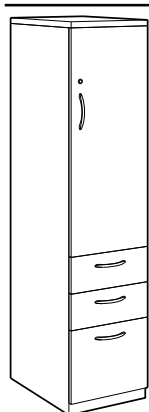

PSTR666612

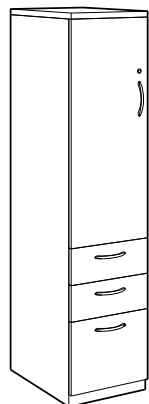

PSTL666612

Sample Part Number:

PSTR521212	.L	.K	.R
------------	----	----	----

Total Cost \$1654 =

\$1654	+	N/C	+	N/C	+	N/C
--------	---	-----	---	-----	---	-----

Pack Pedestal Tower with Bookcase
 The Pack Pedestal Tower with Bookcase combines the functionality of a pedestal with the added storage of a bookcase. The Tower is available in Right- and Left-Hand versions. The Right-Hand version is intended for placement on the right-hand of a workstation with the bookcase facing inward. The Left-Hand version is intended for placement on the left-hand of a workstation with the bookcase facing inward. The Tower is constructed of painted metal and has 1-5/8" adjustable leveling glides. The bookcase unit includes adjustable shelves that can

accommodate two rows of binder storage plus additional storage in the 65-7/8" high towers. The pedestal includes lockable drawers with painted metal drawer fronts. Drawers have full extension ball-bearing slides. Drawers are available with five pull options, including four applied pulls and a bevel pull extending the length of the drawer.

Available accessories include Pack Pedestal Divider/Conversion Kit(PCD), Pack Pencil Tray (HPPT), Lateral File Dividers (LFDE) and Shelf/File Dividers (SFDIV).

When the key-alike lock option "T" is chosen a "disposable" core is assembled in the filing unit to temporarily secure the drawers and doors for transit. The "disposable" cores must be field replaced with Pack Core/Key Sets in order for the Pack filing unit to lock. Core/Key Sets (PLCAK) must be ordered separately or by using the keying order form.

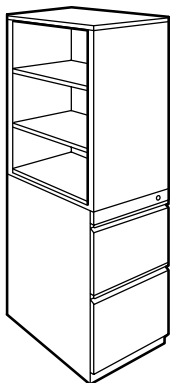

PSTBR661212

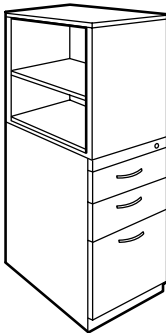

PSTBR526612

Pack Pedestal Tower with Bookcase – Right-Hand

Depth	Dimensions Width	Height	No. of Shelves	List Price	Catalog Number	Pull Style	Trim Color	Lock
23 ¹ / ₂ " (597)	15 ¹ / ₄ " (387)	51 ³ / ₈ " (1305)	1 1	\$1448 1489	PSTBR521212 PSTBR526612	No Cost Bevel B	Standard Finishes No Cost	R No Cost Random
23 ¹ / ₂ " (597)	15 ¹ / ₄ " (387)	65 ⁷ / ₈ " (1673)	2 2	\$1516 1571	PSTBR661212 PSTBR666612	Applied L Classic E Streamline AZ Designer MM Mod2	Premium Finishes + \$141 See Surface Materials Page 6	*T Deduct \$-15 Key-Alike *Note: Be sure to order Core/ Key Sets (PLCAK) sep- arately (1 per unit)

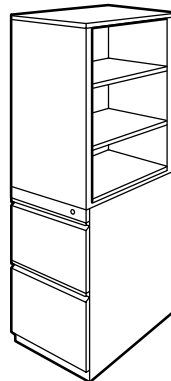

PSTBL661212



PSTBL526612

Pack Pedestal Tower with Bookcase – Left-Hand

Depth	Dimensions Width	Height	No. of Shelves	List Price	Catalog Number
23 ¹ / ₂ " (597)	15 ¹ / ₄ " (387)	51 ³ / ₈ " (1305)	1 1	\$1448 1489	PSTBL521212 PSTBL526612
23 ¹ / ₂ " (597)	15 ¹ / ₄ " (387)	65 ⁷ / ₈ " (1673)	2 2	\$1516 1571	PSTBL661212 PSTBL666612

Build your complete Part Number here:

-----	-	-	-
-------	---	---	---

Sample Part Number:

PSTBR666612	.B	.J	.R
-----	-	-	-

Total Cost \$1571 =

\$1571	+	N/C	+	N/C	+	N/C
--------	---	-----	---	-----	---	-----

Pack Bookcase Wardrobe

The Pack Bookcase Wardrobe Tower & Filing Tower combines the functionality of a pedestal with the added storage of a bookcase and wardrobe. The tower is available in right- and left-hand versions. The right-hand version is intended for placement on the right-hand of a workstation with the bookcase facing inward. The left-hand version is intended for placement on the left-hand of a workstation with the bookcase facing inward. The Tower is constructed of painted metal and has 1-5/8" adjustable leveling glides. The bookcase unit

includes two adjustable shelves that accommodate two rows of binder storage plus additional storage in the 65-7/8" high towers. The pedestal includes lockable drawers with painted metal drawer fronts. Drawers have full-extension ball-bearing slides. The wardrobe includes a two-pronged coat hook. Drawers and wardrobe are available with five pull options, including four applied pulls and a bevel pull extending the length of the drawer or wardrobe.

Available accessories include Pack Pedestal Divider/Conversion Kit (PCD),

Pack Pencil Tray (HPPT), Lateral File Dividers (LFDE) and Shelf/File Dividers (SFDIV).

When the key-alike lock option "T" is chosen a "disposable" core is assembled in the filing unit to temporarily secure the drawers and doors for transit. The "disposable" cores must be field replaced with Pack Core/Key Sets in order for the Pack filing unit to lock. Core/Key Sets (PLCAK) must be ordered separately or by using the keying order form.

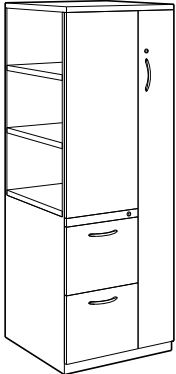

Pack Bookcase Wardrobe Tower & Filing – Right-Hand

Depth	Dimensions		No. of Shelves	List Price	Catalog Number	Pull Style	Trim Color	Lock
	Width	Height						
23'1/2" (597)	23'1/2" (597)	49'3/4" (1264)	1	\$2451	PSTBWR501212 PSTBWR506612	No Cost Bevel B	Standard Finishes No Cost	R No Cost Random
		49'3/4" (1264)	1	2569				
		51'3/8" (1317)	1	2528	PSTBWR521212 PSTBWR526612	Applied L	Premium Finishes + \$141	*T Deduct \$-30 Key-Alike
		51'3/8" (1317)	1	2673				
		57'3/4" (1467)	2	2633	PSTBWR581212 PSTBWR586612	Classic	See Surface Materials Page 6	*Note: Be sure to order Core/Key Sets (PLCAK) separately (2 per unit)
		57'3/4" (1467)	2	2758				
		65'7/8" (1673)	2	2747	PSTBWR661212 PSTBWR666612	E Stream- line		
		65'7/8" (1673)	2	2872				
						AZ Designer		
						MM Mod2		

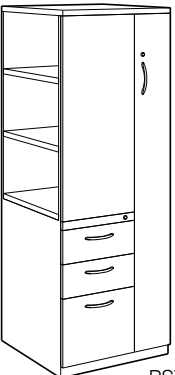

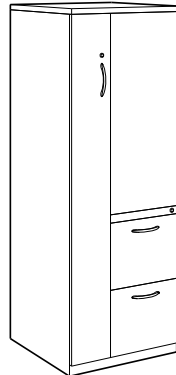

Pack Bookcase Wardrobe Tower & Filing – Left-Hand

Depth	Dimensions		No. of Shelves	List Price	Catalog Number
	Width	Height			
23'1/2" (597)	23'1/2" (597)	49'3/4" (1264)	1	\$2451	PSTBWL501212 PSTBWL506612
		49'3/4" (1264)	1	2569	
		51'3/8" (1317)	1	\$2528	PSTBWL521212 PSTBWL526612
		51'3/8" (1317)	1	2673	
		57'3/4" (1467)	2	2633	PSTBWL581212 PSTBWL586612
		57'3/4" (1467)	2	2758	
		65'7/8" (1673)	2	2747	PSTBWL661212 PSTBWL666612
		65'7/8" (1673)	2	2872	

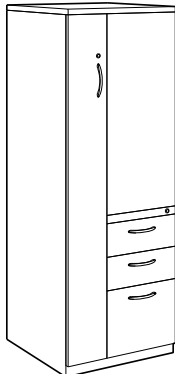

Build your complete Part Number here:

-----	-	-	-
-------	---	---	---

Sample Part Number:	PSTBWR661212	.B -	.J -	.R -
Total Cost \$2747 =	\$2747	+ N/C	+ N/C	+ N/C

Pack Single Lockers

Pack Single Lockers are available in heights to match the four and five-high Pack Lateral File and Double Door Cabinet. The units are constructed of powder-coated steel and have a locking door. Doors are 20 gauge steel. Units include a single fixed shelf, full width wardrobe bar and leveling glides. Single Lockers are available with five pull options, including four applied pulls and a bevel pull extending the length of the door.

Units are available in either a Right-Hand version with the door opening to the right side or a Left-Hand version with the door opening to the left side.

When the key-alike lock option "T" is chosen, a "disposable" core is assembled in the unit to temporarily secure the door for transit. The "disposable" cores must be field replaced with Pack Core/Key Sets in order for the unit to lock. Core/Key Sets (PLCAK) must be ordered separately using design software, online order entry or by the Pack Keying Order Form.



18" Wide Shown

Pack Single Lockers – Right-Hand

Depth	Dimensions Width	Height	List Price	Catalog Number	Pull Style	Trim Color	Lock Option
18" (457)	12" (305)	51 3/8" (1305)	\$1395	PSLR521812	No Cost Bevel B	Standard Finishes No Cost	R No Cost Random
24" (610)		51 3/8" (1305)	1412	PSLR522412			
18" (457)	12" (305)	65 7/8" (1673)	1487	PSLR661812	Applied L Classic	Premium Finishes + \$135	*T Deduct \$-15 Key-Alike
24" (610)		65 7/8" (1673)	1567	PSLR662412			
18" (457)	18" (457)	51 3/8" (1305)	\$1441	PSLR521818	E Stream-line	AZ Designer	*Note: Be sure to order Core/Key Sets (PLCAK) separately (1 per unit)
24" (610)		51 3/8" (1305)	1544	PSLR522418			
18" (457)	18" (457)	65 7/8" (1673)	1681	PSLR661818	MM Mod2		
24" (610)		65 7/8" (1673)	1727	PSLR662418			

Pack Single Lockers – Left-Hand

Depth	Dimensions Width	Height	List Price	Catalog Number
18" (457)	12" (305)	51 3/8" (1305)	\$1395	PSLL521812
24" (610)		51 3/8" (1305)	1412	PSLL522412
18" (457)	12" (305)	65 7/8" (1673)	1487	PSLL661812
24" (610)		65 7/8" (1673)	1567	PSLL662412
18" (457)	18" (457)	51 3/8" (1305)	\$1441	PSLL521818
24" (610)		51 3/8" (1305)	1544	PSLL522418
18" (457)	18" (457)	65 7/8" (1673)	1681	PSLL661818
24" (610)		65 7/8" (1673)	1727	PSLL662418

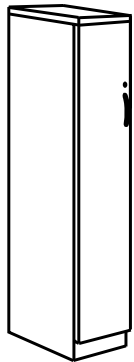

12" Wide Shown

Build your complete Part Number here:

-----	-	-	-
-------	---	---	---

Sample Part Number:

PSLR521812	.L	.K	.R
------------	----	----	----

Total Cost \$1395 =

\$1395	+	N/C	+	N/C	+	N/C
--------	---	-----	---	-----	---	-----

Pack Double Lockers

Pack Double Lockers are constructed of powder-coated steel and have (2) locking doors. Units include leveling glides and a two-pronged coat hook in each locker. Double Lockers are available with five pull options, including four applied pulls and a bevel pull extending the length of the door. Shelves are 18 gauge steel and .75" thick.

Units are available in either a Right-Hand version with all the doors opening to the right side or a Left-Hand version

with all the doors opening to the left side.

When the key-alike lock option "T" is chosen a "disposable" core is assembled in the unit to temporarily secure the door for transit. The "disposable" cores must be field replaced with Pack Core/Key Sets in order for the unit to lock. Core/Key Sets (PLCAK) must be ordered separately using design software, online order entry or by the Pack Keying Order Form.

Pack Double Lockers – Right-Hand

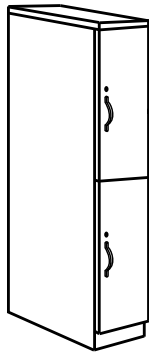

12" Wide Shown

Depth	Dimensions Width	Height	List Price	Catalog Number	Pull Style	Trim Color	Lock Option
18 ¹ / ₄ " (464)	12" (305)	65 ⁷ / ₈ " (1673)	\$1612	PDLR661812	No Cost Applied L Classic E Streamline AZ Designer MM Mod2	Standard Finishes No Cost Premium Finishes + \$135	R No Cost Random *T Deduct \$-30 Key-Alike *Note: Be sure to order Core/Key Sets (PLCAK) separately (2 per unit)
18 ¹ / ₄ " (464)	18" (457)	65 ⁷ / ₈ " (1673)	1755	PDLR661818			

Depth	Dimensions Width	Height	List Price	Catalog Number
18 ¹ / ₄ " (464)	12" (305)	65 ⁷ / ₈ " (1673)	\$1612	PDLL661812
18 ¹ / ₄ " (464)	18" (457)	65 ⁷ / ₈ " (1673)	1755	PDLL661818

Build your complete Part Number here:					- - - - -	-	-	-
--	--	--	--	--	-----------	---	---	---

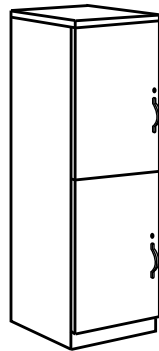

18" Wide Shown

Sample Part Number:

PDLR661812	.L	.K	.R
- - - - -	-	-	-

Total Cost \$1612 =

\$1612	+	N/C	+	N/C	+	N/C
--------	---	-----	---	-----	---	-----

Pack Quad Lockers

Pack Quad Lockers are constructed of powder-coated steel and have (4) locking doors. Units include a two-pronged coat hook in each locker and leveling glides. The center partition is constructed of steel and 1.4" thick. Quad Lockers are available with five pull options, including four applied pulls and a bevel pull extending the length of the door.

Units are available in either a Right-Hand version with all the doors opening to the right side or a Left-Hand version with all the doors opening to the left side.

When the key-alike lock option "T" is chosen a "disposable" core is assembled in the unit to temporarily secure the door for transit. The "disposable" cores must be field replaced with Pack Core/Key Sets in order for the unit to lock. Core/Key Sets (PLCAK) must be ordered separately using design software, online order entry or by the Pack Keying Order Form.

Pack Cubby Lockers

Pack Cubby Lockers are constructed of powder-coated steel and include (4) or (8) locking doors and leveling glides. The center partition is constructed of steel and 1.4" thick. Lockers are available with

five pull options, including four applied pulls and a bevel pull extending the length of the door.

Units are available in either a Right-Hand version with all the doors opening to the right side or a Left-Hand version with all the doors opening to the left side.

When the key-alike lock option "T" is chosen a "disposable" core is assembled in the unit to temporarily secure the door for transit. The "disposable" cores must be field replaced with Pack Core/Key Sets in order for the unit to lock. Core/Key Sets (PLCAK) must be ordered separately using design software, online order entry or by the Pack Keying Order Form.

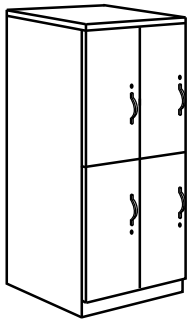

Left Hand Shown

Pack Quad Lockers – Right-Hand

Depth	Dimensions Width	Height	List Price	Catalog Number	Pull Style	Trim Color	Lock Option
18 1/4" (464)	23 1/2" (597)	65 7/8" (1673)	\$2574	PQLR661824	No Cost Bevel B Applied L Classic	Standard Finishes No Cost Premium Finishes + \$135	R No Cost Random *T Deduct \$-60 Key-Alike

Pack Quad Lockers – Left-Hand

Depth	Dimensions Width	Height	List Price	Catalog Number	Pull Style	Trim Color	Lock Option
18 1/4" (464)	23 1/2" (597)	65 7/8" (1673)	\$2574	PQLL661824	E Stream-line AZ Designer MM Mod2		*Note: Be sure to order Core/Key Sets (PLCAK) separately (2 per unit)

Pack Cubby Lockers – Right-Hand

Depth	Dimensions Width	Height	List Price	Catalog Number	Lock Option
18 1/4" (464)	23 1/2" (597)	34 3/4" (883)	\$1927	PCBLR351824	R No Cost Random *T Deduct (4 Locks) \$-60 (8 Locks) \$-120
18 1/4" (464)	23 1/2" (597)	65 7/8" (1673)	\$3306	PCBLR661824	

Pack Cubby Lockers – Left-Hand

Depth	Dimensions Width	Height	List Price	Catalog Number	Lock Option
18 1/4" (464)	23 1/2" (597)	34 3/4" (883)	\$1927	PCBLL351824	*Note: Be sure to order Core/Key Sets (PLCAK) separately (2 per unit)
18 1/4" (464)	23 1/2" (597)	65 7/8" (1673)	\$3306	PCBLL661824	

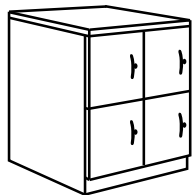

34 3/4" High

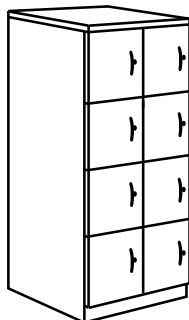

65 7/8" High

Left Hand Shown

Build your complete Part Number here:

_____	_____	_____	_____
-------	-------	-------	-------

Sample Part Number:

PQLR661824	.L	.K	.R
------------	----	----	----

Total Cost \$2574 =

\$2574	+	N/C	+	N/C	+	N/C
--------	---	-----	---	-----	---	-----

PACK LATERAL FILES

The Pack Lateral Files are available with or without pre-installed counterbalance weights. Lateral Files are constructed of metal and include full-extension ball-bearing slides and 1-1/4" leveling glides. Drawer fronts are painted metal and are available with five pull options, including four applied pulls and a bevel pull extending the length of the drawer.

The Pack Two-High Lateral Work Surface Supporting is designed to be used under a work surface and does not have a top. A

top is available separately (PSLATTOP) to change the unit from work surface supporting to freestanding.

Lateral Files come standard with locks which secure the drawer front on both sides for added security. Drawers accommodate side-to-side letter, A4, legal, EDP filing, and include a safety interlock mechanism that allows only one drawer to open at a time.

Accessories include the Pack Freestanding Traverse Kit (FSTK), Lateral File Dividers (LFDE), Pack Lateral File Tops (LFT) and Pack Lateral File Counterbalance Weights (CBWL).

Note: Lateral File Counterbalance Weights are required for individual lateral files that are not ganged back-to-back.

When the key-alike lock option "T" is chosen a "disposable" core is assembled in the filing unit to temporarily secure the drawers and doors for transit. The "disposable" cores must be field replaced with Pack Core/Key Sets in order for the Pack filing unit to lock. Core/Key Sets (PLCAK) must be ordered separately or by using the keying order form.

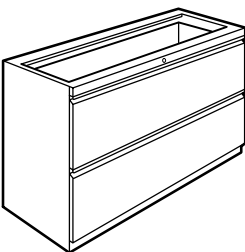

Pack Two-High Lateral Files – Work Surface Supporting

Depth	Dimensions Width	Height	List Price	Catalog Number	Pull Style	Trim Color	Lock
18 1/4" (464)	30" (762)	27 3/4" (705)	\$991	PSLATWS230 PSLATWS236 PSLATWS242	No Cost Bevel B	Standard Finishes No Cost	R No Cost Random
	36" (914)		1059				
	42" (1067)		1135				

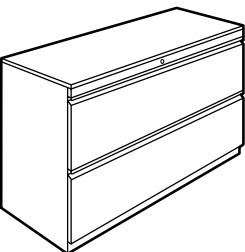

Pack Two-High Lateral Files

Depth	Dimensions Width	Height	List Price	Catalog Number	Pull Style	Trim Color	Lock
18 1/4" (464)	30" (762)	28 3/8" (721)	\$1053	PSLAT230 PSLAT236 PSLAT242	Applied L Classic	Premium Finishes + \$78 2-High	*T Deduct \$-15 Key-Alike
	36" (914)		1161				
	42" (1067)		1279				
With Pre-Installed Counterbalance Weight							
18 1/4" (464)	30" (762)	28 3/8" (721)	\$1313	PSLAT230W PSLAT236W PSLAT242W	E Streamline 3 and 4-High	+ \$141 3 and 4-High	*Note: Be sure to order Core/ Key Sets (PLCAK) separately (1 per unit)
	36" (914)		1421				
	42" (1067)		1538				

Build your complete Part Number here:

PSLAT236	.L	.K	.R
----------	----	----	----

Sample Part Number:

Total Cost \$1161 =

\$1161	+	N/C	+	N/C	+	N/C
--------	---	-----	---	-----	---	-----

Pack Lateral Files continued

Pack Five-High Lateral Files

The Pack Five-High Lateral File has four lateral drawers and an overhead storage unit with a stationary shelf and a door that stores over the top.

When the key-alike lock option "T" is chosen a "disposable" core is assembled in the filing unit to temporarily secure the drawers and doors for transit. The "disposable" cores must be field replaced with Pack Core/Key Sets in order for the Pack filing unit to lock. Core/Key Sets (PLCAK) must be ordered separately or by using the keying order form.

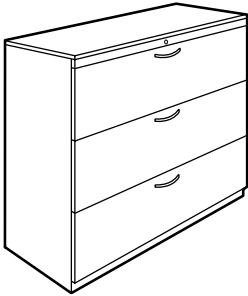

Pack Three-High Lateral Files

Depth	Dimensions Width	Height	List Price	Catalog Number	Pull Style	Trim Color	Lock
18 ¹ / ₄ " (464)	30" (762)	39 ⁷ / ₈ " (1013)	\$1360	PSLAT330 PSLAT336 PSLAT342	No Cost Bevel B	Standard Finishes No Cost	R No Cost Random
	36" (914)		1454				
	42" (1067)		1600				
With Pre-Installed Counterbalance Weight							
18 ¹ / ₄ " (464)	30" (762)	39 ⁷ / ₈ " (1013)	\$1619	PSLAT330W PSLAT336W PSLAT342W	Applied L Classic	Premium Finishes + \$78 2-High	*T Deduct \$-15 Key-Alike
	36" (914)		1712				
	42" (1067)		1860				

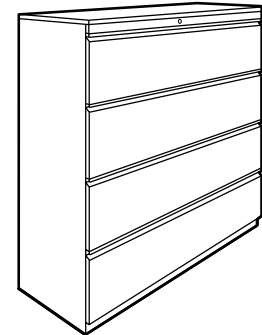

Pack Four-High Lateral Files

Depth	Dimensions Width	Height	List Price	Catalog Number	Pull Style	Trim Color	Lock
18 ¹ / ₄ " (464)	30" (762)	51 ³ / ₈ " (1305)	\$1723	PSLAT430 PSLAT436 PSLAT442	E Streamline	+ \$141 3 and 4-High	*Note: Be sure to order Core/ Key Sets (PLCAK) separately (1 per unit)
	36" (914)		1838				
	42" (1067)		1996				
With Pre-Installed Counterbalance Weight							
18 ¹ / ₄ " (464)	30" (762)	51 ³ / ₈ " (1305)	\$1927	PSLAT430W PSLAT436W PSLAT442W	AZ Designer	See Surface Materials Page 6	
	36" (914)		2096				
	42" (1067)		2256				

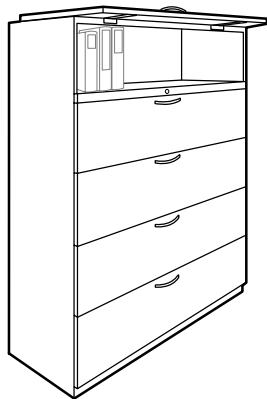

Pack Five-High Lateral Files

Depth	Dimensions Width	Height	List Price	Catalog Number	Pull Style	Trim Color	Lock
18 ¹ / ₄ " (464)	30" (762)	65 ⁷ / ₈ " (1673)	\$2086	PSLAT530 PSLAT536 PSLAT542	MM Mod2		
	36" (914)		2223				
	42" (1067)		2426				
With Pre-Installed Counterbalance Weight							
18 ¹ / ₄ " (464)	30" (762)	65 ⁷ / ₈ " (1673)	\$2290	PSLAT530W PSLAT536W PSLAT542W			
	36" (914)		2426				
	42" (1067)		2632				

Build your complete Part Number here:

---	---	---	---
-----	-----	-----	-----

Sample Part Number:

PSLAT336	.L	.K	.R
----------	----	----	----

Total Cost \$1454 =

\$1454	+ N/C	+ N/C	+ N/C
--------	-------	-------	-------

Pack Six-High Lateral Files

The Pack Six-High Lateral File has five lateral drawers and an over the top storing door with roll-out shelf.

Pack Five-Drawer Lateral Files

The Pack Five-Drawer model has four lateral drawers and an over the top storing door with roll-out shelf.

Accessories include the Pack Freestanding Traverse Kit (FSTK), Lateral File Dividers (LFDE), Pack Lateral File Tops (LFT) and Pack Lateral File Counterbalance Weights (CBWL).

Note: Lateral File Counterbalance Weights are required for individual lateral files that are not ganged back-to-back.

When the key-alike lock option "T" is chosen a "disposable" core is assembled in the filing unit to temporarily secure the drawers and doors for transit. The "disposable" cores must be field replaced with Pack Core/Key Sets in order for the Pack filing unit to lock. Core/Key Sets (PLCAK) must be ordered separately or by using the keying order form.

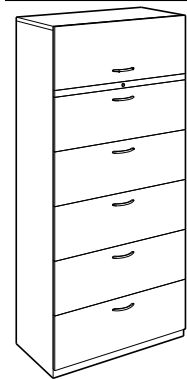

PSLAT630

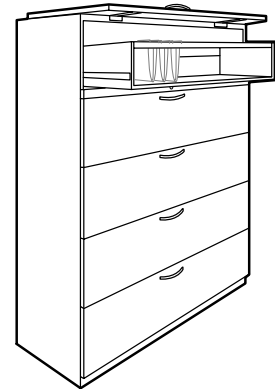

Pack Six-High Lateral Files

Depth	Dimensions Width Height	List Price	Catalog Number	Pull Style	Trim Color	Lock
18 1/4" (464)	30" (762)	77 3/8" (1965)	\$2704	No Cost Bevel B	Standard Finishes No Cost	R No Cost Random
	36" (914)		3021			
	42" (1067)		3275			
With Pre-Installed Counterbalance Weight						
18 1/4" (464)	30" (762)	77 3/8" (1965)	\$2909	Applied L Classic	Premium Finishes + \$141	*T Deduct \$-15 Key-Alike
	36" (914)		3225			
	42" (1067)		3480			
With Pre-Installed Counterbalance Weight						
18 1/4" (464)	30" (762)	77 3/8" (1965)	\$2909	E Streamline	See Surface Materials Page 6	*Note: Be sure to order Core/ Key Sets (PLCAK) sep- arately (1 per unit)
	36" (914)		3225			
	42" (1067)		3480			
With Pre-Installed Counterbalance Weight						
AZ Designer						
MM Mod2						

Pack Five-Drawer Lateral Files

Depth	Dimensions Width Height	List Price	Catalog Number
18 1/4" (464)	30" (762)	65 7/8" (1673)	\$2182
	36" (914)		2308
	42" (1067)		2516
With Pre-Installed Counterbalance Weight			
18 1/4" (464)	30" (762)	65 7/8" (1673)	\$2385
	36" (914)		2514
	42" (1067)		2721
With Pre-Installed Counterbalance Weight			
PSLATD530			
PSLATD536			
PSLATD542			
PSLATD530W			
PSLATD536W			
PSLATD542W			

Build your complete
Part Number here:

----- - - -

Sample
Part Number:

PSLATD542 .B .K .R

Total Cost \$2516 =

\$2516 + N/C + N/C + N/C

Pack Lateral File w/Open Shelves

The Pack Lateral Files w/Open Shelves are available with or without pre-installed counterbalance weights. Lateral Files are constructed of metal and include full-extension ball-bearing slides and leveling glides. Drawer fronts are painted metal and are available with five pull options, including four applied pulls and a bevel pull extending the length of the drawer.

Laterals with 2 open shelves accommodate binder storage on 1 shelf. Units with 3 open shelves accommodate binder storage on two shelves.

Lateral Files include locks. Drawers accommodate side-to-side letter, A4, legal, EDP filing, and include a safety interlock mechanism that allows only one drawer to open at a time.

Accessories include the Pack Freestanding Traverse Kit (FSTK), Lateral File Dividers (LFDE), Pack Lateral File Tops (LFT) and Pack Lateral File Counterbalance Weights (CBWL).

Note: Lateral File Counterbalance Weights are required for individual lateral files that are not ganged back-to-back.

When the key-alike lock option "T" is chosen a "disposable" core is assembled in the filing unit to temporarily secure the drawers and doors for transit. The "disposable" cores must be field replaced with Pack Core/Key Sets in order for the Pack filing unit to lock. Core/Key Sets (PLCAK) must be ordered separately or by using the keying order form.

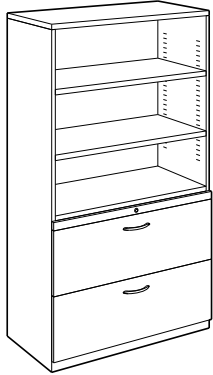

PSLATS2330

Pack Two-High Lateral File w/Open Shelves

Depth	Dimensions		No. of Shelves	List Price	Catalog Number	Pull Style	Trim Color	Lock
	Width	Height						
18 ¹ / ₄ " (464)	30" (762)	51 ³ / ₈ " (1305)	2	\$ 2109	PSLATS2230	No Cost Bevel B	Standard Finishes No Cost	R No Cost Random
	36" (914)		2	2315	PSLATS2236			
	42" (1067)		2	2550	PSLATS2242			
	30" (762)	65 ⁷ / ₈ " (1673)	3	2423	PSLATS2330	Applied L Classic	Premium Finishes + \$141	*T Deduct \$-15 Key-Alike
	36" (914)		3	2722	PSLATS2336			
	42" (1067)		3	3028	PSLATS2342			
With Pre-Installed Counterbalance Weight								
18 ¹ / ₄ " (464)	30" (762)	51 ³ / ₈ " (1305)	2	\$ 2376	PSLATS2230W	E Streamline	See Surface Materials Page 6	*Note: Be sure to order Core/Key Sets (PLCAK) separately (1 per unit)
	36" (914)		2	2582	PSLATS2236W			
	42" (1067)		2	2820	PSLATS2242W			
	30" (762)	65 ⁷ / ₈ " (1673)	3	2690	PSLATS2330W	AZ Designer		
	36" (914)		3	2992	PSLATS2336W			
	42" (1067)		3	3294	PSLATS2342W			
	30" (762)	65 ⁷ / ₈ " (1673)	3	2690	PSLATS2330W	MM Mod2		
	36" (914)		3	2992	PSLATS2336W			
	42" (1067)		3	3294	PSLATS2342W			

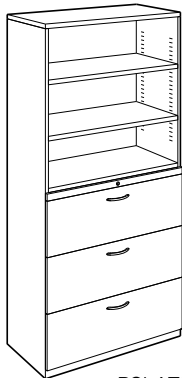

PSLATS3336

Pack Three-High Lateral File w/Open Shelves

Depth	Dimensions		No. of Shelves	List Price	Catalog Number
	Width	Height			
18 ¹ / ₄ " (464)	30" (762)	65 ⁷ / ₈ " (1673)	2	\$ 2548	PSLATS3230
	36" (914)		2	2856	PSLATS3236
	42" (1067)		2	3207	PSLATS3242
	30" (762)	77 ³ / ₈ " (1965)	3	2941	PSLATS3330
	36" (914)		3	3298	PSLATS3336
	42" (1067)		3	3702	PSLATS3342
With Pre-Installed Counterbalance Weight					
18 ¹ / ₄ " (464)	30" (762)	65 ⁷ / ₈ " (1673)	2	\$ 2818	PSLATS3230W
	36" (914)		2	3124	PSLATS3236W
	42" (1067)		2	3476	PSLATS3242W
	30" (762)	77 ³ / ₈ " (1965)	3	3208	PSLATS3330W
	36" (914)		3	3566	PSLATS3336W
	42" (1067)		3	3969	PSLATS3342W

Build your complete Part Number here:

-----	-	-	-
-------	---	---	---

Sample Part Number:

PSLATS3236	.L	.K	.R
-----	-	-	-

Total Cost \$2856 =

\$2856	+	N/C	+	N/C	+	N/C
--------	---	-----	---	-----	---	-----

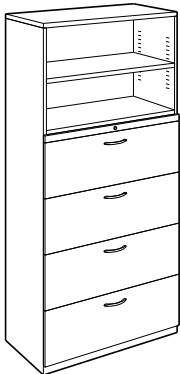

PSLATS4230

Pack Four-High Lateral File w/Open Shelves

Depth	Dimensions Width	Height	No. of Shelves	List Price	Catalog Number	Pull Style	Trim Color	Lock
18 1/4" (464)	30" (762)	77 3/8" (1965)	2	\$3065	PSLATS4230	No Cost Bevel B	Standard Finishes No Cost	R No Cost Random
	36" (914)		2	3434	PSLATS4236			
	42" (1067)		2	3850	PSLATS4242			
With Pre-Installed Counterbalance Weight								
18 1/4" (464)	30" (762)	77 3/8" (1965)	2	\$3278	PSLATS4230W	Applied L Classic	Premium Finishes + \$141	*T Deduct - \$-15 Key-Alike
	36" (914)		2	3645	PSLATS4236W			
	42" (1067)		2	4060	PSLATS4242W			
						E Streamline	See Surface Materials Page 6	*Note: Be sure to order Core/ Key Sets (PLCAK) sep- arately (1 per unit)
						AZ Designer		
						MM Mod2		

Build your complete Part Number here:

_____	_____	_____	_____
-------	-------	-------	-------

Sample Part Number:

PSLATS4236	.L	.K	.R
_____	_____	_____	_____

Total Cost \$3434 =

\$3434	+	N/C	+	N/C	+	N/C
--------	---	-----	---	-----	---	-----

Pack Lateral File w/Storage Cabinets

The Pack Lateral Files with storage shelves are available with or without pre-installed counterbalance weights. Lateral Files are constructed of metal and include full-extension ball-bearing slides and 1-1/4" leveling glides. Drawer fronts are painted metal and are available with five pull options, including four applied pulls and a bevel pull extending the length of the drawer. Lateral Files include locks. Drawers accommodate side-to-side letter, A4, legal, EDP filing, and include a safety interlock mechanism that allows only one drawer to open at a time.

Laterals with 2 shelves accommodate binder storage on 1 shelf. Units with 3 shelves accommodate binder storage on two shelves.

Accessories include the Pack Freestanding Traverse Kit (FSTK), Lateral File Dividers (LFDE), Pack Lateral File Tops (LFT) and Pack Lateral File Counterbalance Weights (CBWL).

Note: Lateral File Counterbalance Weights are required for individual lateral files that are not ganged back-to-back.

When the key-alike lock option "T" is chosen a "disposable" core is assembled in the filing unit to temporarily secure the drawers and doors for transit. The "disposable" cores must be field replaced with Pack Core/Key Sets in order for the Pack filing unit to lock. Core/Key Sets (PLCAK) must be ordered separately or by using the keying order form.

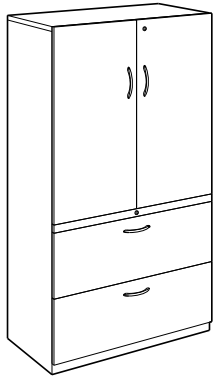

PSLATSC2336

Pack Two-High Lateral File w/Storage Cabinet

Depth	Dimensions Width	Height	No. of Shelves	List Price	Catalog Number	Pull Style	Trim Color	Lock
18 1/4" (464)	30" (762)	51 3/8" (1305)	2	\$2252	PSLATSC2230	No Cost Bevel B	Standard Finishes No Cost	R No Cost Random
	36" (914)		2	2679	PSLATSC2236			
	42" (1067)		2	2915	PSLATSC2242			
	30" (762)	65 7/8" (1965)	3	2691	PSLATSC2330	Applied L Classic	Premium Finishes + \$141	*T Deduct - \$-30 Key-Alike
	36" (914)		3	2994	PSLATSC2336			
	42" (1067)		3	3298	PSLATSC2342			
With Pre-Installed Counterbalance Weight								
18 1/4" (464)	30" (762)	51 3/8" (1673)	2	\$2520	PSLATSC2230W	E Streamline	See Surface Materials Page 6	*Note: Be sure to order Core/Key Sets (PLCAK) separately (2 per unit)
	36" (914)		2	2948	PSLATSC2236W			
	42" (1067)		2	3181	PSLATSC2242W			
	30" (762)	65 7/8" (1965)	3	2957	PSLATSC2330W	AZ Designer		
	36" (914)		3	3259	PSLATSC2336W			
	42" (1067)		3	3566	PSLATSC2342W			
MM Mod2								

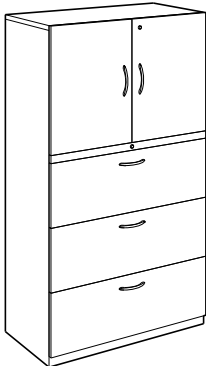

PSLATSC3236

Pack Three-High Lateral File w/Storage Cabinet

Depth	Dimensions Width	Height	No. of Shelves	List Price	Catalog Number
18 1/4" (464)	30" (762)	65 7/8" (1673)	2	\$2772	PSLATSC3230
	36" (914)		2	3081	PSLATSC3236
	42" (1067)		2	3433	PSLATSC3242
	30" (762)	77 3/8" (1965)	3	3209	PSLATSC3330
	36" (914)		3	3568	PSLATSC3336
	42" (1067)		3	3974	PSLATSC3342
With Pre-Installed Counterbalance Weight					
18 1/4" (464)	30" (762)	65 7/8" (1673)	2	\$3040	PSLATSC3230W
	36" (914)		2	3347	PSLATSC3236W
	42" (1067)		2	3700	PSLATSC3242W
	30" (762)	77 3/8" (1965)	3	3478	PSLATSC3330W
	36" (914)		3	3835	PSLATSC3336W
	42" (1067)		3	4240	PSLATSC3342W

Build your complete Part Number here:

----- - - -

Sample Part Number:

PSLATSC2336 .L .K .R

Total Cost \$2994 =

\$2994 + N/C + N/C + N/C

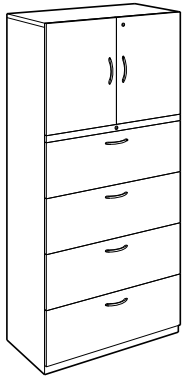

PSLATSC4230

Pack Four-High Lateral File w/Storage Cabinet

Depth	Dimensions Width	Height	No. of Shelves	List Price	Catalog Number	Pull Style	Trim Color	Lock
18 1/4"	30" (762)	77 3/8" (1965)	2	\$3289	PSLATSC4230	No Cost Bevel B	Standard Finishes No Cost	R No Cost Random
	36" (914)		2	3659	PSLATSC4236			
	42" (1067)		2	4076	PSLATSC4242			
With Pre-Installed Counterbalance Weight								
18 1/4"	30" (762)	77 3/8" (1965)	2	\$3502	PSLATSC4230W	Applied L Classic	Premium Finishes + \$141	*T Deduct - \$30 Key-Alike
	36" (914)		2	3868	PSLATSC4236W	E Streamline	See Surface Materials Page 6	*Note: Be sure to order Core/ Key Sets (PLCAK) sep- arately (2 per unit)
	42" (1067)		2	4285	PSLATSC4242W	AZ Designer MM Mod2		

Build your complete
Part Number here:

_____	_____	_____	_____
-------	-------	-------	-------

Sample
Part Number:

PSLATSC4236	.L	.K	.R
_____	_____	_____	_____

Total Cost \$3659 =

\$3659	+	N/C	+	N/C	+	N/C
--------	---	-----	---	-----	---	-----

Pack Lateral File Counterbalance Weights

The Pack Lateral File Counterbalance Weight provides additional stability and must be used for individual lateral files that are not anchored or ganged back-to-back. All hardware is included for field installation.

Pack Two-High Painted Metal Lateral File Top

The Pack Two-High Painted Metal Lateral Top is used to convert a Two-High Lateral – Work Surface Supporting, to a freestanding lateral. Top is a nominal 5/8" (16) thick.

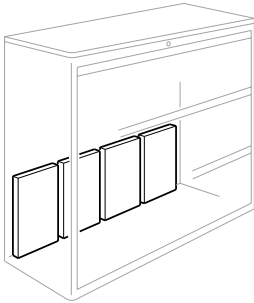

Pack Lateral File Counterbalance Weights

Description	Pieces	List Price	Catalog Number
For Two- and Three-High Units	4	\$259	PSLAT23CW
For Four- and Five-High Units including Five-Drawer	3	204	PSLAT45CW

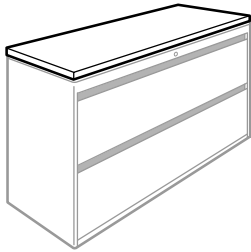

Pack Two-High Painted Metal Lateral File Top

Nominal Depth	Dimensions		List Price	Catalog Number	Trim Color
	Nominal Width				
18 1/4" (464)	30" (762)		\$232	PSLATTOP30	Standard Finishes No Cost Premium Finishes + \$25 See Surface Materials Page 6
	36" (914)		247	PSLATTOP36	
	42" (1067)		259	PSLATTOP42	
Build your complete Part Number here:				-----	-

Sample Part Number:

PSLATTOP42

.J

Total Cost \$259 =

\$259



N/C

Pack Lateral File Tops

Pack Lateral File Tops are sized to be used with Pack Two-Drawer, Three-Drawer, Four-Drawer and Five-Drawer Lateral Files. They are available for use with a single lateral file or combination of two or four lateral files. Lateral File Tops have a high-pressure laminate or Thermofused laminate surface with vinyl edge. Tops are nominal 1¹/₄" (32) thick on high-pressure laminate and nominal 1" (25) thick on Thermofused laminate. Thermofused laminate is only available with matching edge color.

Note: 18¹/₄" (464)-deep Lateral File Tops are sized to fit between Return Panels and can also be used in freestanding applications. 36¹/₂" (927)-deep Lateral File Tops are sized for freestanding applications only.

For non-standard sizes, contact Trendway Custom Solutions 1-800-893-8117.

See Lateral File Top Specification Guide in the Planning section.

Note: Lateral File Tops cannot be used in place of counterbalance weights, ganging or anchoring.

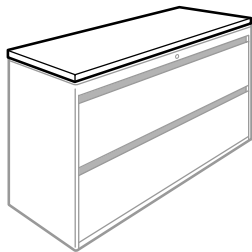

Pack Lateral File Tops – High-Pressure Laminate

Nominal Depth	Dimensions			List Price			Catalog Number	Laminate Color	Edge Color
	Nominal Width	Actual Depth	Actual Width	Laminate Grade 1	Grade 2	Grade 3			
18 ¹ / ₄ " (464)	30" (762)	18 ¹ / ₂ " (470)	29 ¹⁵ / ₁₆ " (760)	\$236	\$248	\$292	PLFT1830E	See Surface Materials Page 7	See Surface Materials Page 6
	36" (914)		35 ¹⁵ / ₁₆ " (913)	258	276	342	PLFT1836E		
	42" (1067)		41 ¹⁵ / ₁₆ " (1065)	286	304	370	PLFT1842E		
	60" (1524)		59 ¹⁵ / ₁₆ " (1522)	363	389	488	PLFT1860E		
	66" (1676)		65 ¹⁵ / ₁₆ " (1675)	394	420	519	PLFT1866E		
	72" (1829)		71 ¹⁵ / ₁₆ " (1827)	421	447	546	PLFT1872E		
	78" (1981)		77 ¹⁵ / ₁₆ " (1980)	424	450	549	PLFT1878E		
	84" (2134)		83 ¹⁵ / ₁₆ " (2132)	425	451	550	PLFT1884E		
36 ¹ / ₂ " (927)	30" (762)	36 ³ / ₄ " (933)	30 ³ / ₁₆ " (767)	\$343	\$369	\$468	PLFT3630E		
	36" (914)		36 ³ / ₁₆ " (919)	388	421	546	PLFT3636E		
	42" (1067)		42 ³ / ₁₆ " (1072)	434	487	692	PLFT3642E		
	60" (1524)		60 ³ / ₁₆ " (1529)	495	536	691	PLFT3660E		
	66" (1676)		66 ³ / ₁₆ " (1681)	555	608	813	PLFT3666E		
	72" (1829)		72 ³ / ₁₆ " (1834)	570	623	828	PLFT3672E		
	78" (1981)		78 ³ / ₁₆ " (1986)	575	628	833	PLFT3678E		
	84" (2134)		84 ³ / ₁₆ " (2138)	580	633	838	PLFT3684E		

Pack Lateral File Tops – Thermofused Laminate

Nominal Depth	Dimensions			List Price		Catalog Number	Top/Edge Color
	Nominal Width	Actual Depth	Actual Width	Thermofused Grade 1	Grade 2		
18 ¹ / ₄ " (464)	30" (762)	18 ¹ / ₂ " (470)	29 ¹⁵ / ₁₆ " (760)	\$195	\$201	ZFPLFT1830	See Surface Materials Page 6
	36" (914)		35 ¹⁵ / ₁₆ " (913)	210	216	ZFPLFT1836	
	42" (1067)		41 ¹⁵ / ₁₆ " (1065)	233	248	ZFPLFT1842	
	60" (1524)		59 ¹⁵ / ₁₆ " (1522)	295	310	ZFPLFT1860	
	66" (1676)		65 ¹⁵ / ₁₆ " (1675)	321	336	ZFPLFT1866	
	72" (1829)		71 ¹⁵ / ₁₆ " (1827)	343	358	ZFPLFT1872	
	78" (1981)		77 ¹⁵ / ₁₆ " (1980)	348	377	ZFPLFT1878	
	84" (2134)		83 ¹⁵ / ₁₆ " (2132)	349	378	ZFPLFT1884	
36 ¹ / ₂ " (927)	30" (762)	36 ³ / ₄ " (933)	30 ³ / ₁₆ " (767)	\$281	\$296	ZFPLFT3630	
	36" (914)		36 ³ / ₁₆ " (919)	317	332	ZFPLFT3636	
	42" (1067)		42 ³ / ₁₆ " (1072)	354	383	ZFPLFT3642	
	60" (1524)		60 ³ / ₁₆ " (1529)	404	433	ZFPLFT3660	
	66" (1676)		66 ³ / ₁₆ " (1681)	455	505	ZFPLFT3666	
	72" (1829)		72 ³ / ₁₆ " (1834)	464	514	ZFPLFT3672	
	78" (1981)		78 ³ / ₁₆ " (1986)	469	536	ZFPLFT3678	
	84" (2134)		84 ³ / ₁₆ " (2138)	477	544	ZFPLFT3684	

Build your complete Part Number here:

----	—	—
------	---	---

Sample Part Number:

PLFT1842E	.J	.K
-----	—	—

Total Cost \$286 =

\$286	+	N/C	+	N/C
-------	---	-----	---	-----

PACK LATERAL FILE ACCESSORIES

Pack Freestanding Traverse Kit

The Pack Freestanding Traverse Kit converts Pack Freestanding Lateral Files and File Centers from standard side-to-side filing to front-to-back filing.

Note: For each drawer, order one kit for 30" (762)- and 36" (914)-wide lateral files; order two kits for 42" (1067)-wide lateral files. See Lateral File Front-to-Back Conversion Bar Application Guide in the Planning section for further information.

Available in Black only.

Lateral File Dividers

The Lateral File Dividers are freestanding dividers that securely attach magnetically to a shelf or drawer bottom.

Available in Black only.

Pack Label Holders

Pack Label Holders attach to Pack filing units. Packaged in boxes of 10 label holders with 10 labels

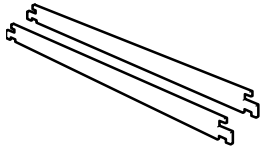

Pack Freestanding Traverse Kit

Description	List Price	Catalog Number
18 1/4" (464) deep laterals (Includes 2 bars)	\$23	FSTK

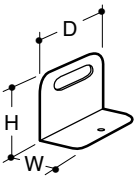

Lateral File Dividers

Dimensions			List Price	Catalog Number
Depth	Width	Height		
8" (203)	4" (102)	7 1/2" (191)	\$101	LFDE
Includes 3 dividers.				

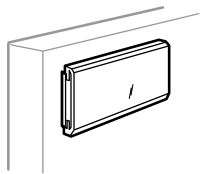

Pack Label Holders

Description	For use with:	List Price	Catalog Number
Includes 10 label holders and 10 Labels	Applied Pull Fronts	\$41	ZLHA

Build your complete Part Number here: _____

Sample Part Number:

LFDE

Total Cost \$101 =

\$101

Pack Double-Door Storage Cabinets

Pack Double-Door Storage Cabinets are available in heights to match the two, three, four and five-high Pack Lateral Files. The units are constructed of painted metal and have locking doors. Painted metal shelves adjust vertically in 1½" increments. The Storage Cabinets are available with five pull options, including four applied pulls and a bevel pull extending the length of the door.

The Pack Work Surface Supporting Double Door Storage Cabinet is designed to be used under a work surface and does not have a top. A top is available separately

to change this unit from work surface supporting to freestanding.

Note: Lateral File Tops (PLFT and/or ZFPLFT) can be used on Pack Double-Door Storage Units to create credenzas or file islands. Use PSDDTOP to transform a Two-High Work Surface Supporting Double Door to a freestanding one.

When the key-alike lock option "T" is chosen a "disposable" core is assembled in the filing unit to temporarily secure the drawers and doors for transit. The "disposable" cores must be field replaced with Pack Core/Key Sets in order for the Pack filing unit to lock. Core/Key Sets (PLCAK) must be ordered separately or by using the keying order form.

Additional storage shelves (SS) are available.

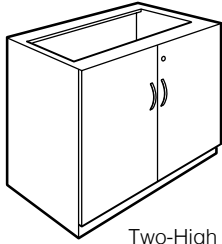

Two-High

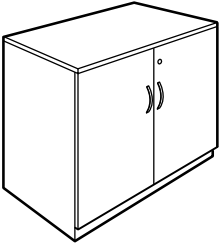

Two-High

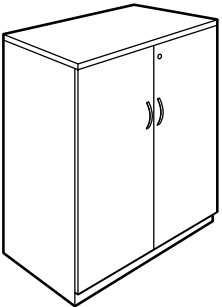

Three-High

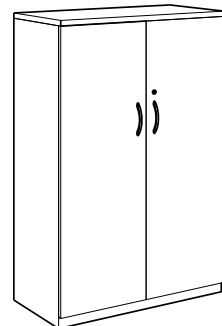

Four-High

Pack Double-Door Storage Cabinet – Work Surface Supporting

Depth	Dimensions Width	Height	Number of Shelves	List Price	Catalog Number	Pull Style	Trim Color	Lock
18 1/4" (464)	36" (914)	27 3/4" (705)	1-Shelf	\$1090	PSDDWS236	No Cost Bevel B	Standard Finishes No Cost	R No Cost Random

Pack Two-High Double-Door Storage Cabinets

Depth	Dimensions Width	Height	Number of Shelves	List Price	Catalog Number
18 1/4" (464)	30" (762)	28 3/8" (721)	1	\$1120	PSDD230
	36" (914)		1	1128	PSDD236
	42" (1067)		1	1436	PSDD242

Pack Three-High Double-Door Storage Cabinets

Depth	Dimensions Width	Height	Number of Shelves	List Price	Catalog Number
18 1/4" (464)	30" (762)	39 7/8" (1013)	2	\$1315	PSDD330
	36" (914)		2	1323	PSDD336
	42" (1067)		2	1732	PSDD342

Pack Four-High Double-Door Storage Cabinets

Depth	Dimensions Width	Height	Number of Shelves	List Price	Catalog Number
18 1/4" (464)	30" (762)	51 3/8" (1305)	3	\$1790	PSDD430
	36" (914)		3	2005	PSDD436
	42" (1067)		3	2085	PSDD442

Build your complete Part Number here:

Sample Part Number:

Total Cost \$1128 =

_____	_____	_____	_____
PSDD236	._E	._J	._R
\$1128	+ N/C	+ N/C	+ N/C

Pack Double-Door Storage Cabinets

Pack Double-Door Storage Cabinets are available in heights to match the two, three, four and five-high Pack Lateral Files. The units are constructed of painted metal and have locking doors. Painted metal shelves adjust vertically in 1-1/2" increments. The Storage Cabinets are available with five pull options, including four applied pulls and a bevel pull extending the length of the door.

The Pack Work Surface Supporting Double Door Storage Cabinet is designed to be used under a work surface and does not have a top. A top is available separately to change this unit from work

surface supporting to freestanding.

Note: Lateral File Tops (PLFT and/ or ZFPLFT) can be used on Pack Double-Door Storage Units to create credenzas or file islands. Use PSDDTOP to transform a Two-High Work Surface Supporting Double Door to a freestanding one.

Pack Double-Door Wardrobe Cabinets

The Pack Wardrobe Cabinet is constructed of painted metal and has locking doors. The Wardrobe Cabinet matches the height of the same High Pack Lateral File, and Double-Door Storage Cabinet. Includes one painted

metal shelf with attached, full-width wardrobe bar.

Additional Storage Shelves (SS) are available.

When the key-alike lock option "T" is chosen a "disposable" core is assembled in the filing unit to temporarily secure the drawers and doors for transit. The "disposable" cores must be field replaced with Pack Core/Key Sets in order for the Pack filing unit to lock. Core/Key Sets (PLCAK) must be ordered separately or by using the keying order form.

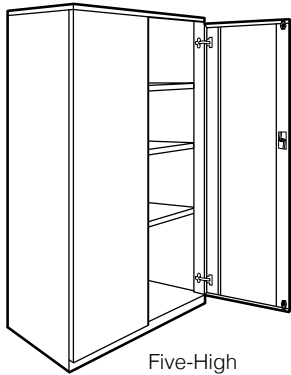

Five-High

Pack Five-High Double-Door Storage Cabinets

Depth	Dimensions Width	Height	Number of Shelves	List Price	Catalog Number	Pull Style	Trim Color	Lock
18 1/4" (464)	30" (762)	65 7/8" (1629)	4	\$1918	PSDD530 PSDD536 PSDD542	No Cost Bevel B (Not available on six-high unit)	Standard Finishes No Cost	R No Cost Random
	36" (914)		4	1923				
	42" (1067)		4	2446				

Pack Six-High Double-Door Storage Cabinets

Depth	Dimensions Width	Height	Number of Shelves	List Price	Catalog Number	Applied L Classic	See Surface Materials Page 6	*T Deduct \$-15 Key-Alike
18 1/4" (464)	30" (762)	77 3/8" (1965)	5	\$2466	PSDD630 PSDD636 PSDD642	E Streamline AZ Designer	MM Mod2	*Note: Be sure to order Core/Key Sets (PLCAK) separately (1 per unit)
	36" (914)		5	2581				
	42" (1067)		5	2722				

Pack Five-High Double-Door Wardrobe Cabinet

Depth	Dimensions Width	Height	Number of Shelves	List Price	Catalog Number
18 1/4" (464)	36" (914)	65 7/8" (1629)	1-Shelf	\$1767	PSWR536

Pack Six-High Double-Door Wardrobe Cabinet

Depth	Dimensions Width	Height	Number of Shelves	List Price	Catalog Number
18 1/4" (464)	36" (914)	77 3/8" (1965)	1-Shelf	\$2581	PSWR636

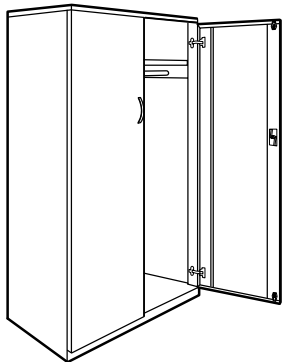

Build your complete Part Number here:

-----	-	-	-
-------	---	---	---

Sample Part Number:

PSDD636	.E	.J	.R
---------	----	----	----

Total Cost \$2581 =

\$2581	+	N/C	+	N/C	+	N/C
--------	---	-----	---	-----	---	-----

DOUBLE-DOOR, AND WARDROBE ACCESSORIES

Storage Shelves

The Storage Shelf fits in Pack Double-Door Storage Cabinets for additional shelf space. Includes 4 shelf clips.

Wardrobe Bars

The Wardrobe Bar converts a five-high Double-Door Storage Unit to a Wardrobe Unit. Wardrobe Bar attaches to the Storage Shelf.

Pack Two-High Double-Door Cabinet Top

The Pack Two-High Cabinet Double-Door Top includes the top to retrofit a Two-High Double-Door Storage Cabinet – Work Surface Supporting to a free-standing Double-Door.



Storage Shelves

Depth	Dimensions Width	Height	List Price	Catalog Number	Trim Color
15 ³ / ₈ " (391)	30" (762)	1" (25)	\$81	SS30E2	Standard Finishes No Cost Premium Finishes + \$25 See Surface Materials Page 6
15 ³ / ₈ " (391)	36" (914)	1" (25)	\$81	SS36E2	
15 ³ / ₈ " (391)	42" (1067)	1" (25)	\$81	SS42E2	

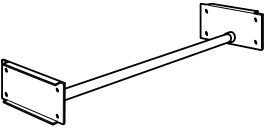

Wardrobe Bars (For Five-High Double-Door Storage Unit)

Dimensions Width	Height	List Price	Catalog Number
36" (914)	1" (25) Diameter	\$99	WRB36E



Pack Double-Door Cabinet Top

Depth	Dimensions Width	Height	List Price	Catalog Number
18 ¹ / ₄ " (464)	36" (914)	5 ⁵ / ₈ " (16)	\$247	PSDDTOP36

Build your complete Part Number here:

----	-
------	---

Sample Part Number:

WRB36E	.G
--------	----

Total Cost \$99 =

\$99	+	N/C
------	---	-----

Pack Floor-Supported File Center
 The Pack file center combines the functionality of a pedestal and Pack lateral file into a single cabinet that fits below a systems work surface.

Available accessories include the Pack freestanding traverse kit (FSTK) for front-to-back filing, lateral file dividers (LFDE) and label holders (ZLHA).

Note: Floor-Supported file center must be attached to a panel-mounted work surface or a desk unit.

When the key-alike lock option "T" is chosen a "disposable" core is assembled in the filing unit to temporarily secure the drawers and doors for transit. The "disposable" cores must be field replaced with Pack Core/Key Sets in order for the Pack filing unit to lock. Core/Key Sets (PLCAK) must be ordered separately or by using the keying order form.

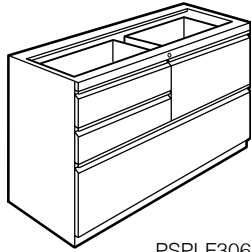

PSPLF306612

Pack Floor-Supported File Center

Depth	Dimensions Width	Height	List Price	Catalog Number	Pull Style	Trim Color	Lock
18 ³ / ₈ " (467)	30 ¹ / ₂ " (775)	27 ³ / ₄ " (705)	\$1299 1299 1334	PSPLF301266 PSPLF306612 PSPLF301212	No Cost Bevel B Applied L Classic E Streamline AZ Designer MM Mod2	Standard Finishes No Cost Premium Finishes + \$78 See Surface Materials Page 6	R No Cost Random *T Deduct \$-15 Key-Alike *Note: Be sure to order Core/ Key Sets (PLCAK) sep- arately (1 per unit)
Build your complete Part Number here:				-----	-	-	-

Sample Part Number:

PSPLF306612	.B	.G	.R
-----	-	-	-

Total Cost \$1299 =

\$1299	+	N/C	+	N/C	+	N/C
--------	---	-----	---	-----	---	-----

Pack Freestanding Pedestals

Freestanding Pedestals are available in 3 depths to work with different work surface depths. Units can be placed under the work surface but are not work surface supporting. Shallower depths allow access behind the pedestal for plug accessibility and cable management. Pedestals include lockable drawers with painted metal drawer fronts and full extension ball-bearing slides and a factory installed counter-balance weight. Drawers are available with five pull options, including four applied pulls and a bevel pull extending the length of the drawer.

Available accessories include Pack Pedestal Divider/Conversion Kit (PCD), Pack Pencil Tray (HPPT).

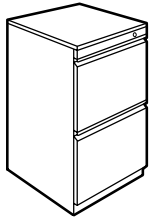

PSPFSTD191212



PSPFSTD196612

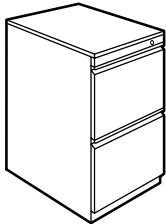

PSPFSTD221212

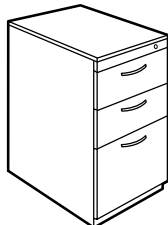

PSPFSTD226612

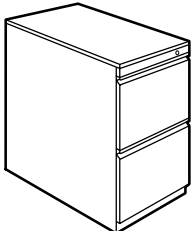

PSPFSTD281212

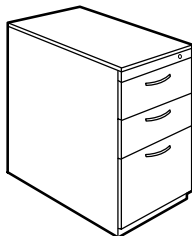

PSPFSTD286612

Pack Freestanding Pedestals

Depth	Dimensions Width	Height	List Price	Catalog Number	Pull Style	Trim Color	Lock
18 ⁷ / ₈ " (479)	15 ¹ / ₄ " (387)	27 ³ / ₄ " (705)	\$683 724	PSPFSTD191212 PSPFSTD196612	No Cost Bevel B	Standard Finishes No Cost	R No Cost Random
21 ⁷ / ₈ " (556)	15 ¹ / ₄ " (387)	27 ³ / ₄ " (705)	\$697 739	PSPFSTD221212 PSPFSTD226612	Applied L Classic	Premium Finishes + \$63	*T Deduct \$-15 Key-Alike
27 ⁷ / ₈ " (708)	15 ¹ / ₄ " (387)	27 ³ / ₄ " (705)	\$751 793	PSPFSTD281212 PSPFSTD286612	E Streamline AZ Designer MM Mod2	See Surface Materials Page 6	*Note: Be sure to order Core/ Key Sets (PLCAK) sep- arately (1 per unit)

Build your complete
Part Number here:

----- - - -

Sample
Part Number:

PSPFSTD221212 .B .J .R

Total Cost \$697 =

\$697 + N/C + N/C + N/C

Pack Support Pedestals

The Work Surface Supporting Pedestal mounts beneath the work surface. Pedestals include lockable drawers with painted metal drawer fronts, full extension ball-bearing slides, 1⁵/₈" leveling glides and mounting hardware. Drawers are available with five pull options, including four applied pulls and a bevel pull extending the length of the drawer.

Available accessories include Pack Pedestal Divider/Conversion Kit (PCD), Pack Pencil Tray (HPPT).

Pack Hanging Pedestals

The Hanging Pedestal suspends beneath the work surface. It includes lockable drawers with painted metal fronts, full extension ball-bearing slides and mounting hardware. Drawers are available with four pull options, including four applied pulls and an integral bevel pull.

Available accessories include Pack Pedestal Divider/Conversion Kit (PCD), Pack Pencil Tray (HPPT).

Freestanding desks with two full end panels can accommodate up to 2 hanging pedestals per desk.

Freestanding desk with P-Leg supports, returns and system work surfaces, when attached next to an end panel or panel return with support brackets, can accommodate one hanging pedestal.

When the key-alike lock option "T" is chosen a "disposable" core is assembled in the filing unit to temporarily secure the drawers and doors for transit. The "disposable" cores must be field replaced with Pack Core/Key Sets in order for the Pack filing unit to lock. Core/Key Sets (PLCAK) must be ordered separately or by using the keying order form.



PSP1212



PSP6612

Pack Work Surface Supporting Pedestals

Depth	Dimensions Width	Height	List Price	Catalog Number	Pull Style	Trim Color	Lock
21 ⁷ / ₈ " (556)	15 ¹ / ₄ " (387)	27 ³ / ₄ " (705)	\$620 634	PSP1212 PSP6612	No Cost Bevel B Applied L Classic E Streamline AZ Designer MM Mod2	Standard Finishes No Cost Premium Finishes + \$63 See Surface Materials Page 6	R No Cost Random *T Deduct \$-15 Key-Alike *Note: Be sure to order Core/Key Sets (PLCAK) separately

Pack Hanging Pedestals

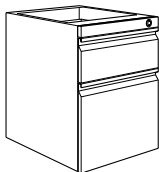

Depth	Dimensions Width	Height	List Price	Catalog Number
17 ⁷ / ₈ " (454)	15 ¹ / ₄ " (387)	19 ³ / ₈ " (492)	\$568	PSHP18612
21 ⁷ / ₈ " (556)			580	PSHP22612

Build your complete Part Number here:

---	---	---	---
-----	-----	-----	-----

Sample Part Number:

PSP6612	.L	.J	.R
----------------	-----------	-----------	-----------

Total Cost \$634 =

\$634	+	N/C	+	N/C	+	N/C
-------	---	-----	---	-----	---	-----

Pack Mobile Pedestals

The Mobile Pedestal includes two locking and two non-locking casters, lockable drawers with painted metal drawer fronts, full extension ball-bearing slides, and a factory installed counterbalance weight. Drawers are available with five pull options, including four applied pulls and a bevel pull extending the length of the drawer.

Available accessories include Pack Pedestal Divider/Conversion Kit (PCD), Pack Pencil Tray (HPPT).

Pack 3/4 Mobile Pedestals

The Mobile Pedestal includes two locking and two non-locking casters, lockable drawers with painted metal drawer fronts, full extension ball-bearing slides, and a factory installed counterbalance weight. Drawers are available with five pull options, including four applied pulls and a bevel pull extending the length of the drawer.

The 3/4 Mobile Pedestal can be teamed with a cushion top, providing guest seat and storage in one piece.

Available accessories include Pack Pedestal Divider/Conversion Kit (PCD), Pack Pencil Tray (HPPT).

Note: All Pack Mobile Pedestals are sold with a pull on the lock strip. If an Applied Pull is specified for the drawers, the lock strip pull will match. If a Bevel Pull is specified, the lock strip will feature a simple generic pull.

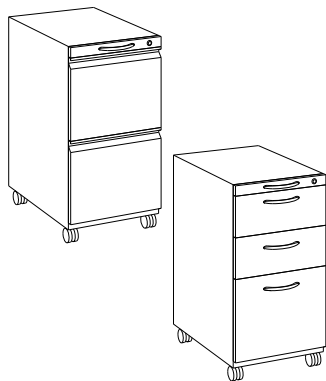

Pack Mobile Pedestals

Depth	Dimensions Width	Height	List Price	Catalog Number	Pull Style	Trim Color	Lock
21 ⁷ / ₈ " (556)	15 ¹ / ₄ " (387)	27 ³ / ₈ " (695)	\$691 748	PSMP1212 PSMP6612	No Cost Bevel B	Standard Finishes No Cost	R No Cost Random
18 ⁷ / ₈ " (479)			691 748	PSMP181212 PSMP186612	Applied L Classic	Premium Finishes + \$63	*T Deduct \$-15 Key-Alike
27 ⁷ / ₈ " (708)			881 930	PSMP271212 PSMP276612	E Streamline AZ Designer	See Surface Materials Page 6	*Note: Be sure to order Core/Key Sets (PLCAK) separately (1 per unit)

Pack Mobile Pedestals w/Pencil Drawer

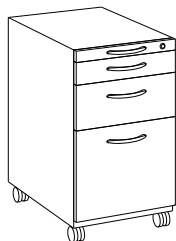

Depth	Dimensions Width	Height	List Price	Catalog Number
18 ⁷ / ₈ " (479)	15 ¹ / ₄ " (387)	24" (610)	\$823	PSMP183612
21 ⁷ / ₈ " (556)			878	PSMP213612
27 ⁷ / ₈ " (708)			1024	PSMP273612

Pack 3/4 Mobile Pedestals

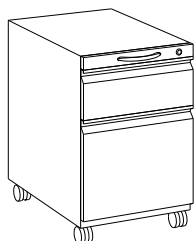

Depth	Dimensions Width	Height	List Price	Catalog Number
21 ⁷ / ₈ " (556)	15 ¹ / ₄ " (387)	21" (533)	\$751	PSMP612
18 ⁷ / ₈ " (479)	15 ¹ / ₄ " (387)	21" (533)	653	PSMP18612
27 ⁷ / ₈ " (708)	15 ¹ / ₄ " (387)	21" (533)	826	PSMP27612

Build your complete
Part Number here:

-----	-	-	-
-------	---	---	---

Sample
Part Number:

PSMP612	.L	.P	.R
-----	-	-	-

Total Cost \$751 =

\$751	+	N/C	+	N/C	+	N/C
-------	---	-----	---	-----	---	-----

Pack Mobile Pedestal Cushion

The Pedestal Cushion includes a 1" thick upholstered cushion and four attached Velcro tabs to affix cushion. This cushion top can only be used on Pack Mobile Pedestals.

When the key-alike lock option "T" is chosen a "disposable" core is assembled in the filing unit to temporarily secure the drawers and doors for transit. The "disposable" cores must be field replaced with Pack Core/Key Sets in order for the Pack filing unit to lock. Core/Key Sets (PLCAK) must be ordered separately or by using the keying order form.

PEDESTAL AND FILE CENTER ACCESSORIES

Pack Pedestal Divider/Conversion Kit (Also for use with File Centers)

The Pedestal Divider/Conversion Kit is used to divide drawer space in the 6" (152) drawer. The 12" (305) Divider/Conversion Kit is used to divide and compress letter size files, or can convert the 12" (305) drawer to side-to-side or legal-size filing.

Available in Black only.

Pack Pencil Tray

The Pencil Tray organizes small items in both the 6" (152) and 12" (305) Pack Pedestal drawers and Lateral File Center drawers.

Available in Black only.

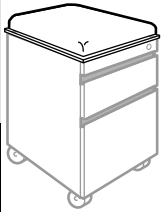

Pack Mobile Pedestal Cushion

Dimensions Fits Pedestal	Depth	Width	List Price Fabric Grade											Catalog Number	Seating Fabric Color
			A	B	C	D	E	F	G	H	I	J	K		
21 ⁷ / ₈ " (556)	15 ¹ / ₄ " (387)		\$211	\$233	\$249	\$272	\$301	\$328	\$361	\$395	\$412	\$436	\$465	MPCTK MPCTK1915 MPCTK2815	See Seating price book Surface Material section
18 ⁷ / ₈ " (479)			211	233	249	272	301	328	361	395	412	436	465		
27 ⁷ / ₈ " (708)			247	272	299	329	364	397	451	504	531	562	596		
Build your complete Part Number here:													-----	-	

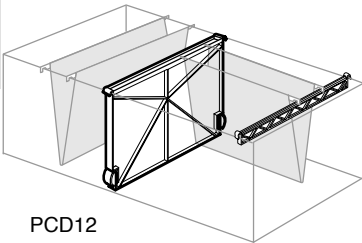

PCD12

Pack Pedestal Divider/Conversion Kit

Width	Dimensions Height	Description	List Price	Catalog Number
12 ³ / ₄ " (324)	4 ⁵ / ₈ " (117) 9 ⁵ / ₈ " (244)	Includes 5 dividers. Includes 5 dividers and conversion bars.	\$50 82	PCD6 PCD12

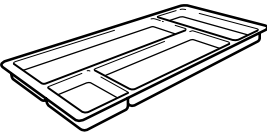

Pack Pencil Tray

Depth	Dimensions Width	Height	Description	List Price	Catalog Number
5 ¹ / ₂ " (140)	13 ³ / ₈ " (340)	1" (25)	Includes 1 pencil tray.	\$18	HPPT
Build your complete Part Number here:					-----

Sample Part Number:

HPPT -----

Total Cost \$18 =

\$18

Pack Bookcases

The Bookcase is complete with metal top and base with leveling glides. Leveling glide allows for 5/8" (16) adjustment. The bookcase is constructed of painted metal. The outside panels are flush with the sides of the bookcase top for no-gap allowance in side-by-side applications. The shelves are 1" (25)-thick, and adjust in 1/2" (13)-height increments. All Bookcase heights are designed to accommodate standard binders on all but one shelf on each unit.

Available accessories include Shelf/File Dividers (SFDIV) and Bookcase Shelves (BCBS36).

Pack Mobile Bookcase

The mobile bookcase comes standard with black casters, two (2) locking and two (2) non-locking. The bookcase is available with optional pull styles. Pulls are located on both sides of the unit.

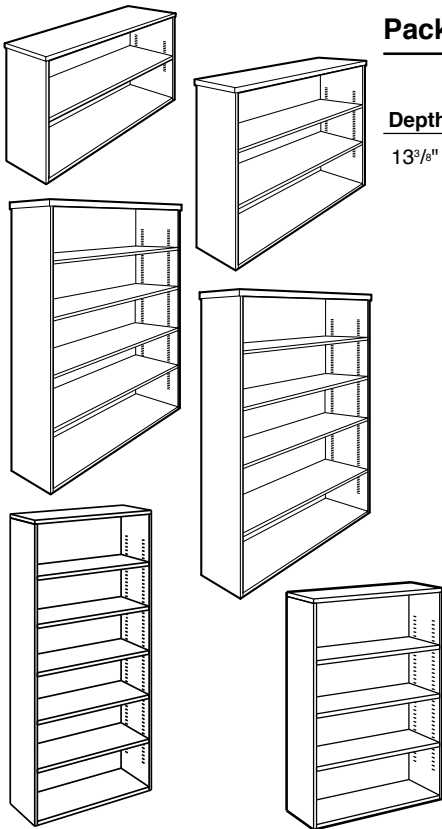

Pack Bookcases

Depth	Dimensions Width	Height	Units High	No. of Shelves	List Price	Catalog Number	Trim Color
13 ³ / ₈ " (340)	30" (762)	27 ³ / ₄ " (705)	2-High	1	\$689	PSBC230	Standard Finishes No Cost
	36" (914)			1	697	PSBC236	
	42" (1067)			1	904	PSBC242	
30" (762)	36" (914)	39 ⁷ / ₈ " (1013)	3-High	2	783	PSBC330	Premium Finishes + \$78 2-High
	36" (914)			2	790	PSBC336	
	42" (1067)			2	998	PSBC342	
30" (762)	36" (914)	51 ³ / ₈ " (1305)	4-High	3	1026	PSBC430	+ \$141 3, 5, 6 and 70"-High See Surface Materials Page 6
	36" (914)			3	1065	PSBC436	
	42" (1067)			3	1107	PSBC442	
30" (762)	36" (914)	65 ⁷ / ₈ " (1673)	5-High	4	1018	PSBC530	
	36" (914)			4	1026	PSBC536	
	42" (1067)			4	1224	PSBC542	
36" (762)	70" (1778)		5-High	4	1112	PSBC7036	
30" (762)	36" (914)	77 ⁷ / ₈ " (1965)	6-High	5	1230	PSBC630	
	36" (914)			5	1271	PSBC636	
	42" (1067)			5	1318	PSBC642	

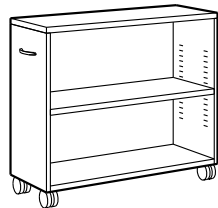

Pack Mobile Bookcase

Dimensions Depth	Width	Height	List Price	Catalog Number	Pull Style	Trim Color
15 ¹ / ₄ " (387)	32 ¹ / ₂ " (826)	26 ¹ / ₂ " (673)	\$1023	PSBCM232	Applied L Classic E Streamline AZ Designer MM Mod2	Standard Finishes No Cost Premium Finishes + \$78 2-High
Build your complete Part Number here:				----	-	-
Sample Part Number:				PSBC536	.Y	
Total Cost \$1026 =				\$1026	+	N/C

Pack Bookcase Shelves

Bookcase Shelves are used for additional shelf space. Includes one shelf and mounting hardware.

Shelf/File Dividers

Shelf/File Dividers are freestanding dividers that securely attach magnetically to a shelf or drawer bottom. Includes three dividers. Available in all trim colors.



Pack Bookcase Shelves

Fits Bookcase Width	Depth	Dimensions		List Price	Catalog Number	Trim Color
		Actual Width	Height			
30" (762)	12 ⁷ / ₈ " (327)	30" (762)	1" (25)	\$92	BCAS30 BCBS36 BCCS42	Standard Finishes No Cost Premium Finishes + \$25 See Surface Materials Page 6
36" (914)		33 ⁵ / ₈ " (854)		\$92		
42" (1067)		42" (1067)		\$92		

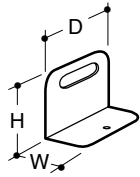

Shelf/File Dividers

Depth	Dimensions Width	Height	List Price	Catalog Number	Trim Color
8" (203)	4" (102)	7 ¹ / ₂ " (191)	\$111	SFDIV	Standard Smooth Finish Only See Surface Materials Page 6
Includes 3 dividers.					

Build your complete Part Number here:

_____	_____
-------	-------

Sample Part Number:

BCBS36	.Y
--------	----

Total Cost \$92 =

\$92	+	N/C
------	---	-----

Terms & Policies

<u><i>Terms & Policies</i></u>	<u>44</u>
<u><i>Warranty</i></u>	<u>47</u>
<u><i>Index</i></u>	<u>48</u>

1. Prices

Prices shown in this price list are F.O.B. origin, freight prepaid, in the contiguous United States. Trendway Corporation reserves the right to change prices without notice. Trendway may implement price changes effective at time of shipment if shipping date is more than 120 days from date written order was received by Trendway.

Pricing for shipments outside the contiguous United States will be based on the port of departure. Freight will be prepaid to port of departure.

List prices include coverage of prepaid standard, Trendway-specified freight cost.

2. Order Placement

Trendway Corporation requires all orders to be submitted electronically via on-line order entry at www.trenddealer.com, or in writing following Ordering Procedures on page 1. Trendway recommends using design software for larger projects which allows the dealer to design, specify, and enter an order more efficiently and accurately which will assure completeness and avoid errors and duplications. The Buyer assumes all responsibility for the correct content of any order which has been acknowledged.

3. Confirmation

Upon receiving an order, Trendway Corporation will send an acknowledgement with exact pricing information and scheduled shipping date. Orders can also be confirmed on-line at www.trenddealer.com. Customer is responsible for checking acknowledgements to ensure that the order is correct. Order will be processed as acknowledged.

4. Lead-Times

Trendway Corporation reserves the right to alter lead times as demand for products fluctuate. Stated lead-times begin after a complete order is entered and scheduled. Shipments are subject to product availability. Special products and larger orders may extend lead-times. Orders placed by dealers without a requested delivery date will be assigned a delivery date of 4 weeks for standard product orders and 6 weeks for custom product orders. Please contact your customer care representative for exact lead-times.

5. Buyer's Credit

If, in the judgment of Trendway, the financial condition of the Buyer at any time does not justify the terms specified, Trendway may at any time

by notice to the Buyer require prepayment or other terms of payment differing from those specified in Section 8 or other satisfactory security to insure prompt payment of invoices.

6. Order Changes

To change an order, the customer must call Trendway Customer Care for order status. If approved, the customer must confirm the changes in writing to Trendway Corporation. Customer agrees to accept any and all charges involved in altering an order. This includes payment, determined by Trendway, for product already in production. Changes in orders also may result in delayed shipments.

7. Cancellation

All cancellations must be approved by Trendway Corporation. **Orders in production cannot be cancelled without incurring substantial or full purchase price.** Customers shall agree to accept any and all charges involved in the cancellation transaction, as determined by Trendway. Non-standard items may not be cancelled.

8. Terms of Sale

Terms of sale on all invoices to approved Trendway customers are Net 30 days from date of invoice. These terms may be changed at any time by Trendway Corporation based on credit rating information available on specific customers. Payment in advance may be requested at the discretion of Trendway without explanation.

9. Taxes

Prices listed do not include any federal, state, local, or other taxes. Purchaser agrees to pay or reimburse any such taxes that Trendway Corporation, Trendway Corporation subcontractors, or suppliers are required to pay. For shipments to AZ, CA, CO, DC, FL, GA, IL, IN, KS, MA, MI, MN, MS, NJ, NY, OH, PA, TX and Canada, add appropriate tax rate. All authorized dealers should ensure that a resale exemption certificate is on file with Trendway Corporation.

10. Past-Due Accounts

Past-due accounts will be charged 1.5% per month. This is an annual rate of 18% or the highest legal rate on the unpaid balance. The purchaser agrees to pay all collection agency fees, court costs, and/or reasonable attorney fees incurred by Trendway in the collection of past-due balances.

11. Customer's Own Material (COM)

The Trendway COM program allows customers to use special materials. By complying with the COM testing for manufacturability procedure in the

steps below, Trendway will be able to identify if your material is appropriate for application to the products you specify.

To comply with the COM process, please follow these steps:

1. Select the COM material.
2. Check first with www.trenddealer.com/COM Library, to determine if this material has already passed testing for manufacturability on the intended product.
3. If the material is pre-approved in the COM Library, customer must submit a *COM Order Submission Form* (available from Trendway Customer Care Representative).
4. If the material requested is not in the COM Library, customer must submit a *COM* test request on-line at www.trenddealer.com, send a sample of the COM material (see Test Yardage Requirements below), and include a list of Trendway product numbers designated for the COM application. Material sample should include pattern name, pattern number and color, manufacturer, direction material should be applied, and Control number from the COM Request Form automated e-mail response.
5. Ship COM samples to:

U.S. Mail and UPS, FedEx Shipment:
Trendway Corporation
13467 Quincy Street
Holland, MI 49424
Attn: COM Request
6. You will be notified within five working days of receiving the material sample by Trendway, whether your COM has been approved or disapproved for application.

TEST YARDAGE REQUIREMENTS

Capture Tiles	1 yard
Choices panels	1½ yards
Fabric screens	2 yards
Flipper doors	2/3 yard
Intrinsic Freestanding	1 yard
Ped Cushions	1 yard
Seating	Trendway requests
Seating - Parley	1 yard
Seating - Zego	1½ yards
Tackboards	1 yard
TrendWall	4 yards
Volo tiles	4 yards

NOTE: Most fabric houses have a yardage minimum or an upcharge on less than one-yard cuts.

NOTE: All COM applications are priced at Grade 1 or Grade A.

If Buyer desires to use his own material

in the production of Trendway's products, it is necessary to obtain the prior written consent of Trendway. Material provided by the Buyer shall be shipped to seller, freight prepaid, and all risk of loss or damage shall remain with Buyer. Buyer must assume responsibility for any use spoilage that takes place in the course of processing or during transportation. Buyer hereby holds Trendway harmless against any and all claims for loss, liability, injury, or damage arising from use of customer material; and Buyer takes full responsibility for performance and quality of customer material. Buyer should also be aware that Buyer-furnished materials will not qualify for UL Listings and may not meet fire codes. Please discuss specific concerns and special needs with Trendway Customer Care PRIOR to placing your order.

11a. Custom Color

Trendway's Custom Color program allows the customer to specify their own color or stain on many of Trendway's products. See www.trenddealer.com for product availability, individual product guidelines and lead times. Set up fees and lead times are product specific and will vary.

To request a Custom Color or Stain:

- Complete a Custom Color Request form (available on www.trenddealer.com).
- Send request form along with two 2"x3" samples to Trendway Customer Care Color Coordinator.
- After the receipt of the request, Trendway will provide customer with one color sample.
- If approved, Dealer or customer completes custom color form, providing the custom match color number on the back of the sample, signs, and returns by fax or mail to Custom Color Coordinator.
- Samples will be matched under cool white florescent lighting. All orders processed under the Custom Color program will be manufactured within commercially acceptable tolerances.
- If applicable, dealer will be sent an invoice for \$250 color matching fee per customer, per color. See Custom Color Request form for details.

12. Special Product

When Trendway purchases special surface materials (i.e., fabrics and laminates) at the request of the customer, the customer takes full responsibility for the performance and quality of the surface material.

13. Delays

Trendway shall not be liable for loss or damage due to delay in manufacturing or delivery resulting from any cause beyond Trendway's reasonable control, including, but not limited to, compliance with any regulations, orders, or instructions of any Federal, State, or Municipal Government, or any department or agency thereof, acts of God, acts or omissions of Buyer, acts of civil or military authority, fires, strikes, factory shutdowns or alterations, embargoes, war, riot, delays in transportation or inability due to causes beyond Trendway's reasonable control to obtain necessary labor, manufacturing facilities, or material from Trendway's usual sources. In no event shall Trendway be liable for special or consequential damages for any delay for any cause.

14. Postponement of Delivery

If unforeseen circumstances occur, Trendway Corporation may postpone delivery of ordered products. Customer will be notified when such postponement occurs.

15. Storage

When shipment is delayed by the Buyer, Trendway reserves the right to place the goods in storage at customer's risk and cost. Trendway charges 1/4 of 1% of list price per week to cover storage. All terms and conditions of the sale, including but not limited to invoicing and payment, will continue as Buyer-specified destination; except that title remains with Trendway and that Trendway reserves the right to modify payment terms to assure recovery of any additional cost incurred.

16. Transportation

All orders shipped to any destination, within the contiguous United States, will be F.O.B. origin, freight prepaid, and risk of loss or damage shall pass to Buyer upon delivery to carrier. Trendway will determine the method and agency of transportation to be used.

Exceptions to standard prepaid freight are as follows:

- Customer directed expedites (Air Freight, Team Hauls) will be prepaid by Trendway and Customer will be billed the difference between standard and expedited freight.
- Truckload deliveries that are requested to deliver on weekends, Holidays or after 12:00 noon EST on Friday's will have an additional charge of \$450 per truck.
- Excessive unloading (in excess of 2 hours) will be billed at \$50 per hour after the initial 4 hour unloading period.
- LTL shipments normally deliver

between 8:00 am and 5:00 pm, Monday through Friday. A specific delivery time on your assigned delivery date can be requested for an additional charge of \$150. This charge does not apply to full-truckload shipments. Requests for specific dates/times falling outside standard delivery timeframe for the carrier serving your area constitute Expedites (see Customer-Directed Expedites, above). Expedite charges do apply to full-truckload shipments.

- Lift gate service will have an additional charge of \$85 for an LTL carrier. For lift gate service on a truckload, contact Customer Care.
- Inside delivery service starts at \$50. Call Customer Care for quote.
- Reconsignment cost after shipment, starts at \$50. Call Customer Care for quote.
- Special equipment requirements call for a quote.

In the event that special F.O.B. Destination terms are agreed to by Trendway or delivery is made on Trendway-owned or -leased equipment, customer or authorized representative is responsible for noting any freight damage or shortage on the freight bill of lading at time of delivery and must notify Trendway within five (5) days of delivery day of any such damage or shortage. Assistance in a concealed damage claim on an F.O.B. Destination shipment will be provided by Trendway only if the product has been immediately unpacked and both the carrier and Trendway have been promptly notified of resultant damage so the proper inspection can be made.

Shipping Note:

Trendway strives to minimize packaging to help the environment and to make installations faster and cleaner.

Trendway ships products in using various packaging methods based upon the product type and shipping method (full truck vs. LTL), all of which are designed to provide protection for the product while minimizing packaging materials.

Trendway test packaging designs to ensure their effectiveness.

17. Product Ownership

Title and risk of loss to all goods sold shall pass to Buyer upon Trendway's

delivery to Buyer or to a carrier at shipping point. Trendway, however, retains the Purchase Money Security Interest in all goods shipped and the right to perfect same.

18. Damaged Materials

Trendway Corporation is not responsible for shipped products when the common carrier is in receipt of the material. Trendway expects all customers to thoroughly inspect orders on receipt regardless of point of delivery. Clear receipt should not be given on the material until it has been checked for damage in transit. All claims for noted damaged material must be made by the customer to Trendway Customer Care.

Concealed damage or damage not noted at time of delivery shall be made by the customer to the common carrier within 5 days after receipt. Trendway assumes no liability for such damage.

19. Shortage on Order

Shortage on ordered products must be reported to Trendway Corporation within five (5) days of product delivery and must be noted on bill of lading at time of delivery.

20. Product Usage and Compliance

Buyer assumes full responsibility for the application of Trendway's product to Buyer's use, and compliance with Trendway installation and maintenance instructions and reasonable load restrictions. Compliance to local code restrictions regarding fire, electrical, and building codes are the responsibility of the customer or his authorized agent.

21. Post-Delivery Assistance

Installation and servicing of Trendway products are normally handled directly by Trendway-authorized dealers. When this is not possible, assistance is available by calling Trendway's Customer Care Department, Holland, Michigan.

22. Returned Goods

As a basic policy, Trendway does not accept returned material, because most items are manufactured per order and are not in stock at the factory. If material is authorized for return because of Trendway error, shipment may be made freight collect. Any other goods for which Trendway does authorize a return will be sent prepaid and a restocking charge of 35% will apply. **To receive authorization to return goods, please contact Trendway's Customer Care Department.**

All Returned Materials Authorizations expire thirty (30) days from date of issue. Any product returned after 30 days will be refused and returned to sender collect.

Electrical components, nonstandard items, and fabric-covered goods may

not be returned. Replacement products will be billed to you with credit being issued upon return of the product in good condition. All goods returned must be in the original Trendway packing cartons. Goods will be inspected for damage upon return. No credit will be issued for goods which are damaged. **As a general statement of policy, return authorization will not be issued for items unless they are Trendway stock items.**

23. Intrinsic Key-Alike Option

The Intrinsic Key-Alike option is available on all Intrinsic filing units for no additional upcharge. When the Key-Alike option is chosen, the list price of the purchased Intrinsic filing unit is reduced by the same amount that is charged when ordering the Intrinsic Core/Key Set (ZFLCK) needed for that unit.

The unit is assembled with a "disposable" core in place of the lock core to temporarily secure the drawers/doors for transit. In order for Key-Alike Intrinsic units to lock, the "disposable" core must be field replaced with an Intrinsic Core/Key Set (ZFLCK) which is ordered separately.

Intrinsic Core/Key Set orders should be placed with the Intrinsic filing order to ensure being installed at the time of product installation. The Core/Key Set (ZFLCK) can be ordered separately or by using the key-alike order form which can also be used as a worksheet to help combine and tag Core/Key Sets.

24. Special Marking or Tagging

Special tagging is available on all orders free of charge. Trendway suggests this option to simplify the staging and installation of product. **Tag designations must be specified at the time an order is placed.**

25. Trendway Field Technical and Installation Support:

On-site field measurement and installation support is available as a service. The fees are listed below:

Field Installation Assistance: 2 Day On-Site, \$1,200

Field Installation Assistance: 3 Days On-Site, \$1,800

Field Installation Assistance: 4 Days On-site, \$2,400

Field Installation Assistance: 5 Days On-Site, \$3,000

Days include 1/2 day travel to and 1/2 day travel from location. These fees are based on a minimum 14 business days advanced notification and booking. Service requests booked less than 14 business days in advance may be subject to additional fees due to added travel cost. For more information or

to place a request, contact Trendway Customer Care at 1-616-399-3900.

Find the most current terms and conditions on www.Trendway.com, in the Price list section.

Limited Lifetime Warranty

Trendway Corporation warrants to the original purchaser that the products described in its price lists, sold after August 1, 2004 will be free from defects in materials and workmanship commencing with the date of initial purchase and continuing for as long as the original owner uses these products. This warranty provides limits on the following products:

	Systems	Architectural Product	Seating
10 Year	<ul style="list-style-type: none"> •Electrical Components •Height-Adjustable Table Frame 		<ul style="list-style-type: none"> •Pneumatic Cylinder •Mechanisms
5 Year	<ul style="list-style-type: none"> •Drawer Slides •Systems Textiles •Finishes •Electronic Ballasts •Height-Adjustable Table Mechanical Components 	<ul style="list-style-type: none"> •System Textiles •Finishes 	
3 Year	<ul style="list-style-type: none"> •Veneer •Magnetic Ballasts 		<ul style="list-style-type: none"> •Trim •Foam •Upholstery •Arm Pads
2 Year	<ul style="list-style-type: none"> •Surface Trend Fabrics •Height-Adjustable Table Electrical Components 	<ul style="list-style-type: none"> •Surface Trend Fabrics 	
1 Year	<ul style="list-style-type: none"> •Non-Standard Product •Personal Task Lighting 	<ul style="list-style-type: none"> •Non-Standard Product 	<ul style="list-style-type: none"> •Non-Standard Product •Rexxi Chair
Not Covered	<ul style="list-style-type: none"> •Light Bulbs •Customer's Own Material 	<ul style="list-style-type: none"> •Customer's Own Material 	<ul style="list-style-type: none"> •Customer's Own Material

The following exceptions apply to all product lines:

- The Trendway warranty applies to normal three shift office use, with the exception of seating. Seating is warranted for single-shift usage.
- Damage caused by improper treatment of the product including exposure to unusual environmental conditions (extreme climates, acids, and moisture)

This comprehensive warranty applies to all products installed or reconfigured by a Trendway authorized installer. Trendway will repair, or at its option, replace defective merchandise, free of charge, which, when used normally and pursuant to Trendway's published instructions, and applicable planning guide information, prove to be defective within the period stated. This remedy is expressly agreed to be exclusive as a condition of sale. No person is authorized to assume for Trendway any warranty liability, except as expressly set forth in this paragraph, or set forth in writing by an authorized officer of the company at its headquarters in Holland, Michigan.

Any and all labor charge backs must be pre-approved by Trendway's Customer Care Manager in writing. Trendway will reimburse authorized Trendway dealers and service centers for approved warranty labor during the first year of use.

This warranty does not apply to damage resulting from accident, alteration, transport, or misuse, as well as damage from normal wear and tear such as dents, nicks, scratches, fading and improper maintenance. Trendway employs quality measures to ensure color consistency in our products. However, due to the effects of light and other environmental factors, no guarantee can be made for an exact match to product in an existing installation.

Natural variations occurring in materials such as wood and leather are not considered defects, and Trendway does not warrant the matching of colors, grains, textures or colorfastness of these materials.

Trendway provides a three-year warranty on veneer products for quality and craftsmanship. Due to the natural properties of wood, the following are not covered under this warranty:

- Changes in wood color resulting from exposure to light or aging
- Natural color variation between wood veneer and solid wood pieces, or resulting from veneer lay-up
- Natural variation in wood grain or the presence of character marks
- Normal wear and tear
- Exact match to swatch materials

Trendway makes no warranty to purchasers who acquire products for personal, family, or household purposes, or to purchasers acquiring the product other than directly from Trendway Corporation, its authorized dealers, or others who are specifically authorized by Trendway to sell such products. Trendway's liability with respect to its products shall not exceed that expressly set forth above irrespective of the theory upon which a claim might be based, including negligence. Under no circumstances shall Trendway be liable for incidental or consequential damages. Original product label must be attached to the product in question.

The warranty period is not interrupted or prolonged by the performance of a service under the terms of the warranty. There are no other warranties except as expressly set forth above, either express or implied, including any warranty of design, merchantability or fitness for any purpose.

This warranty supersedes all previously printed Trendway warranties.

Trendway Corporation
13467 Quincy St., Holland MI 49422-9016
www.trendway.com 09.12

Catalog Number	Description	Page	Catalog Number	Description	Page
BCAS30	Bookcase Shelves.....	42	PSDD230	Two-High Double-Door Storage Cabinet.....	33
BCBS36	Bookcase Shelves.....	42	PSDD236	Two-High Double-Door Storage Cabinet.....	33
BCCS42	Bookcase Shelves.....	42	PSDD242	Two-High Double-Door Storage Cabinet.....	33
CRK	Core Installation / Removal Key.....	13	PSDD330	Three-High Double-Door Storage Cabinet.....	33
FSTK	Freestanding Traverse Kit.....	32	PSDD336	Three-High Double-Door Storage Cabinet.....	33
HPPT	Pencil Tray.....	40	PSDD342	Three-High Double-Door Storage Cabinet.....	33
LFDE	Lateral File Divider.....	32	PSDD430	Four-High Double-Door Storage Cabinet.....	33
MPCTK	Mobile Pedestal Cushion.....	40	PSDD436	Four-High Double-Door Storage Cabinet.....	33
MPCTK1915	Mobile Pedestal Cushion.....	40	PSDD442	Four-High Double-Door Storage Cabinet.....	33
MPCTK2815	Mobile Pedestal Cushion.....	40	PSDD530	Five-High Double-Door Storage Cabinet.....	34
PCD12	Pedestal Divider/Conversion Kit.....	40	PSDD536	Five-High Double-Door Storage Cabinet.....	34
PCD6	Pedestal Divider/Conversion Kit.....	40	PSDD552	Five-High Double-Door Storage Cabinet.....	34
PCBLL341824	Pack Cubby Lockers - Left Hand.....	22	PSDD630	Six-High Double-Door Storage Cabinet.....	34
PCBLL661824	Pack Cubby Lockers - Left Hand.....	22	PSDD636	Six-High Double-Door Storage Cabinet.....	34
PCBLR341824	Pack Cubby Lockers - Right Hand.....	22	PSDD642	Six-High Double-Door Storage Cabinet.....	34
PCBLR341824	Pack Cubby Lockers - Right Hand.....	22	PSDDTOP36	Double-Door Cabinet Top.....	35
PDLR51812	Pack Double Lockers - Left Hand.....	21	PSDDWS236	Double-Door Storage Cabinet - WS Supporting.....	33
PDLR51818	Pack Double Lockers - Left Hand.....	21	PSHP18612	Hanging Pedestals.....	38
PDLR51812	Pack Double Lockers - Right Hand.....	21	PSHP22612	Hanging Pedestals.....	38
PDLR51818	Pack Double Lockers - Right Hand.....	21	PSLAT230	Two-High Lateral File.....	23
PLCAK	Core / Key Sets.....	13	PSLAT230W	Two-High Lateral File with Counterbalance.....	23
PLFT1830E	Lateral File Top - HPL.....	31	PSLAT236	Two-High Lateral File.....	23
PLFT1836E	Lateral File Top - HPL.....	31	PSLAT236W	Two-High Lateral File with Counterbalance.....	23
PLFT1842E	Lateral File Top - HPL.....	31	PSLAT23CW	Lateral File Counterbalance Weights.....	30
PLFT1860E	Lateral File Top - HPL.....	31	PSLAT242	Two-High Lateral File.....	23
PLFT1866E	Lateral File Top - HPL.....	31	PSLAT242W	Two-High Lateral File with Counterbalance.....	23
PLFT1872E	Lateral File Top - HPL.....	31	PSLAT330	Three-High Lateral File.....	24
PLFT1878E	Lateral File Top - HPL.....	31	PSLAT330W	Three-High Lateral File with Counterbalance.....	24
PLFT1884E	Lateral File Top - HPL.....	31	PSLAT336	Three-High Lateral File.....	24
PLFT3630E	Lateral File Top - HPL.....	31	PSLAT336W	Three-High Lateral File with Counterbalance.....	24
PLFT3636E	Lateral File Top - HPL.....	31	PSLAT342	Three-High Lateral File.....	24
PLFT3642E	Lateral File Top - HPL.....	31	PSLAT342W	Three-High Lateral File with Counterbalance.....	24
PLFT3660E	Lateral File Top - HPL.....	31	PSLAT430	Four-High Lateral File.....	24
PLFT3666E	Lateral File Top - HPL.....	31	PSLAT430W	Four-High Lateral File with Counterbalance.....	24
PLFT3672E	Lateral File Top - HPL.....	31	PSLAT436	Four-High Lateral File.....	24
PLFT3678E	Lateral File Top - HPL.....	31	PSLAT436W	Four-High Lateral File with Counterbalance.....	24
PLFT3684E	Lateral File Top - HPL.....	31	PSLAT442	Four-High Lateral File.....	24
PLKS	Pack Lock Keys.....	13	PSLAT442W	Four-High Lateral File with Counterbalance.....	24
PQLL51824	Pack Quad Lockers - Left Hand.....	22	PSLAT45CW	Lateral File Counterbalance Weights.....	30
PQLR51824	Pack Quad Lockers - Right Hand.....	22	PSLAT530	Five-High Lateral File.....	24
PSBC230	Bookcases.....	41	PSLAT530W	Five-High Lateral File with Counterbalance.....	24
PSBC236	Bookcases.....	41	PSLAT536	Five-High Lateral File.....	24
PSBC242	Bookcases.....	41	PSLAT536W	Five-High Lateral File with Counterbalance.....	24
PSBC330	Bookcases.....	41	PSLAT542	Five-High Lateral File.....	24
PSBC336	Bookcases.....	41	PSLAT542W	Five-High Lateral File with Counterbalance.....	24
PSBC342	Bookcases.....	41	PSLAT630	Six-High Lateral File.....	25
PSBC430	Bookcases.....	41	PSLAT630W	Six-High Lateral File with Counterbalance.....	25
PSBC436	Bookcases.....	41	PSLAT636	Six-High Lateral File.....	25
PSBC442	Bookcases.....	41	PSLAT636W	Six-High Lateral File with Counterbalance.....	25
PSBC530	Bookcases.....	41	PSLAT642	Six-High Lateral File.....	25
PSBC536	Bookcases.....	41	PSLAT642W	Six-High Lateral File with Counterbalance.....	25
PSBC542	Bookcases.....	41	PSLATD530	Five-Drawer Lateral File.....	25
PSBC630	Bookcases.....	41	PSLATD530W	Five-Drawer Lateral File with Counterbalance.....	25
PSBC636	Bookcases.....	41	PSLATD536	Five-Drawer Lateral File.....	25
PSBC642	Bookcases.....	41	PSLATD536W	Five-Drawer Lateral File with Counterbalance.....	25
PSBC7036	Bookcases.....	41	PSLATD542	Five-Drawer Lateral File.....	25
PSBCM232	Mobile Bookcase.....	41	PSLATD542W	Five-Drawer Lateral File with Counterbalance.....	25

Catalog Number	Description	Page	Catalog Number	Description	Page
PSLATS2230	Two-High Lateral File w/Open Shelves	26	PSLATSC2336	Two-High Lat. File w/Storage Cabinet	28
PSLATS2230W	Two-High Lateral File w/Open Shelves w/counterbalance.....	26	PSLATSC2336W	Two-High Lat. File w/Storage Cabinet w/counterbalance.....	28
PSLATS2236	Two-High Lateral File w/Open Shelves	26	PSLATSC2342	Two-High Lat. File w/Storage Cabinet	28
PSLATS2236W	Two-High Lateral File w/Open Shelves w/counterbalance.....	26	PSLATSC2342W	Two-High Lat. File w/Storage Cabinet w/counterbalance.....	28
PSLATS2242	Two-High Lateral File w/Open Shelves	26	PSLATSC3230	Three-High Lat. File w/Storage Cabinet	28
PSLATS2242W	Two-High Lateral File w/Open Shelves w/counterbalance.....	26	PSLATSC3230W	Three-High Lat. File w/Storage Cabinet w/counterbalance.....	28
PSLATS2330	Two-High Lateral File w/Open Shelves	26	PSLATSC3236	Three-High Lat. File w/Storage Cabinet	28
PSLATS2330W	Two-High Lateral File w/Open Shelves w/counterbalance.....	26	PSLATSC3236W	Three-High Lat. File w/Storage Cabinet w/counterbalance.....	28
PSLATS2336	Two-High Lateral File w/Open Shelves	26	PSLATSC3242	Three-High Lat. File w/Storage Cabinet	28
PSLATS2336W	Two-High Lateral File w/Open Shelves w/counterbalance.....	26	PSLATSC3242W	Three-High Lat. File w/Storage Cabinet w/counterbalance.....	28
PSLATS2342	Two-High Lateral File w/Open Shelves	26	PSLATSC3330	Three-High Lat. File w/Storage Cabinet	28
PSLATS2342W	Two-High Lateral File w/Open Shelves w/counterbalance.....	26	PSLATSC3330W	Three-High Lat. File w/Storage Cabinet w/counterbalance.....	28
PSLATS3230	Three-High Lateral File w/Open Shelves.....	26	PSLATSC3336	Three-High Lat. File w/Storage Cabinet	28
PSLATS3230W	Three-High Lateral File w/Open Shelves w/counterbalance.....	26	PSLATSC3336W	Three-High Lat. File w/Storage Cabinet w/counterbalance.....	28
PSLATS3236	Three-High Lateral File w/Open Shelves.....	26	PSLATSC3342	Three-High Lat. File w/Storage Cabinet	28
PSLATS3236W	Three-High Lateral File w/Open Shelves w/counterbalance.....	26	PSLATSC3342W	Three-High Lat. File w/Storage Cabinet w/counterbalance.....	28
PSLATS3242	Three-High Lateral File w/Open Shelves.....	26	PSLATSC4230	Four-High Lat. File w/Storage Cabinet.....	29
PSLATS3242W	Three-High Lateral File w/Open Shelves w/counterbalance.....	26	PSLATSC4230W	Four-High Lat. File w/Storage Cabinet w/counterbalance.....	29
PSLATS3330	Three-High Lateral File w/Open Shelves.....	26	PSLATSC4236	Four-High Lat. File w/Storage Cabinet.....	29
PSLATS3330W	Three-High Lateral File w/Open Shelves w/counterbalance.....	26	PSLATSC4236W	Four-High Lat. File w/Storage Cabinet w/counterbalance.....	29
PSLATS3336	Three-High Lateral File w/Open Shelves.....	26	PSLATSC4242	Four-High Lat. File w/Storage Cabinet.....	29
PSLATS3336W	Three-High Lateral File w/Open Shelves w/counterbalance.....	26	PSLATSC4242W	Four-High Lat. File w/Storage Cabinet w/counterbalance.....	29
PSLATS3342	Three-High Lateral File w/Open Shelves.....	26	PSLATTOP30	Two-High Painted Metal Lat. File Top.....	30
PSLATS3342W	Three-High Lateral File w/Open Shelves w/counterbalance.....	26	PSLATTOP36	Two-High Painted Metal Lat. File Top.....	30
PSLATS4230	Four-High Lateral File w/Open Shelves.....	27	PSLATTOP42	Two-High Painted Metal Lat. File Top.....	30
PSLATS4230W	Four-High Lateral File w/Open Shelves w/counterbalance.....	27	PSLATWS230	Two-Hight Lateral File - Work Surface Supporting ...	23
PSLATS4236	Four-High Lateral File w/Open Shelves.....	27	PSLATWS236	Two-Hight Lateral File - Work Surface Supporting ...	23
PSLATS4236W	Four-High Lateral File w/Open Shelves w/counterbalance.....	27	PSLATWS242	Two-Hight Lateral File - Work Surface Supporting ...	23
PSLATS4242	Four-High Lateral File w/Open Shelves.....	27	PSLL41812	Pack Single Lockers - Left Hand.....	20
PSLATS4242W	Four-High Lateral File w/Open Shelves w/counterbalance.....	27	PSLL42412	Pack Single Lockers - Left Hand.....	20
PSLATSC2230	Two-High Lat. File w/Storage Cabinet	28	PSLL51812	Pack Single Lockers - Left Hand.....	20
PSLATSC2230W	Two-High Lat. File w/Storage Cabinet w/counterbalance.....	28	PSLL52412	Pack Single Lockers - Left Hand.....	20
PSLATSC2236	Two-High Lat. File w/Storage Cabinet	28	PSLL41818	Pack Single Lockers - Left Hand.....	20
PSLATSC2236W	Two-High Lat. File w/Storage Cabinet w/counterbalance.....	28	PSLL42418	Pack Single Lockers - Left Hand.....	20
PSLATSC2242	Two-High Lat. File w/Storage Cabinet	28	PSLL51818	Pack Single Lockers - Left Hand.....	20
PSLATSC2242W	Two-High Lat. File w/Storage Cabinet w/counterbalance.....	28	PSLL52418	Pack Single Lockers - Left Hand.....	20
PSLATSC2330	Two-High Lat. File w/Storage Cabinet	28	PSLR41812	Pack Single Lockers - Right Hand.....	20
PSLATSC2330W	Two-High Lat. File w/Storage Cabinet w/counterbalance.....	28	PSLR42412	Pack Single Lockers - Right Hand.....	20
			PSLR51812	Pack Single Lockers - Right Hand.....	20
			PSLR52412	Pack Single Lockers - Right Hand.....	20
			PSLR41818	Pack Single Lockers - Right Hand.....	20
			PSLR42418	Pack Single Lockers - Right Hand.....	20
			PSLR51818	Pack Single Lockers - Right Hand.....	20
			PSLR52418	Pack Single Lockers - Right Hand.....	20
			PSMP1212	Mobile Pedestals	39
			PSMP181212	Mobile Pedestals	39

Catalog Number	Description	Page
PSMP183612	Mobile Pedestals w/pencil Drawer.....	39
PSMP18612	3/4 Mobile Pedestal.....	39
PSMP186612	Mobile Pedestals.....	39
PSMP213612	Mobile Pedestals w/pencil Drawer.....	39
PSMP271212	Mobile Pedestals.....	39
PSMP273612	Mobile Pedestals w/pencil Drawer.....	39
PSMP27612	3/4 Mobile Pedestal.....	39
PSMP276612	Mobile Pedestals.....	39
PSMP612	3/4 Mobile Pedestal.....	39
PSMP6612	Mobile Pedestals.....	39
PSMSTWL441212	Mobile Wardrobe Tower - Left Hand.....	16
PSMSTWL561212	Mobile Wardrobe Tower - Left Hand.....	16
PSMSTWL566612	Mobile Wardrobe Tower - Left Hand.....	16
PSMSTWR441212	Mobile Wardrobe Tower - Right Hand.....	16
PSMSTWR561212	Mobile Wardrobe Tower - Right Hand.....	16
PSMSTWR566612	Mobile Wardrobe Tower - Right Hand.....	16
PSP1212	Work Surface Supporting Pedestal.....	38
PSP6612	Work Surface Supporting Pedestal.....	38
PSPFSTD191212	Freestanding Pedestals.....	37
PSPFSTD196612	Freestanding Pedestals.....	37
PSPFSTD221212	Freestanding Pedestals.....	37
PSPFSTD226612	Freestanding Pedestals.....	37
PSPFSTD281212	Freestanding Pedestals.....	37
PSPFSTD286612	Freestanding Pedestals.....	37
PSPLF301212	Floor-Supported File Center.....	36
PSPLF301266	Floor-Supported File Center.....	36
PSPLF306612	Floor-Supported File Center.....	36
PSSTWL401212	Storage Tower - Left Hand.....	15
PSSTWL406612	Storage Tower - Left Hand.....	15
PSSTWL501212	Storage Tower - Left Hand.....	15
PSSTWL50121212	Storage Tower - Left Hand.....	15
PSSTWL506612	Storage Tower - Left Hand.....	15
PSSTWL521212	Storage Tower - Left Hand.....	15
PSSTWL52121212	Storage Tower - Left Hand.....	15
PSSTWL526612	Storage Tower - Left Hand.....	15
PSSTWL581212	Storage Tower - Left Hand.....	15
PSSTWL58121212	Storage Tower - Left Hand.....	15
PSSTWL586612	Storage Tower - Left Hand.....	15
PSSTWL661212	Storage Tower - Left Hand.....	15
PSSTWL66121212	Storage Tower - Left Hand.....	15
PSSTWL666612	Storage Tower - Left Hand.....	15
PSSTWR401212	Storage Tower - Right Hand.....	15
PSSTWR406612	Storage Tower - Right Hand.....	15
PSSTWR501212	Storage Tower - Right Hand.....	15
PSSTWR50121212	Storage Tower - Right Hand.....	15
PSSTWR506612	Storage Tower - Right Hand.....	15
PSSTWR521212	Storage Tower - Right Hand.....	15
PSSTWR52121212	Storage Tower - Right Hand.....	15
PSSTWR526612	Storage Tower - Right Hand.....	15
PSSTWR581212	Storage Tower - Right Hand.....	15
PSSTWR58121212	Storage Tower - Right Hand.....	15
PSSTWR586612	Storage Tower - Right Hand.....	15
PSSTWR661212	Storage Tower - Right Hand.....	15
PSSTWR66121212	Storage Tower - Right Hand.....	15
PSSTWR666612	Storage Tower - Right Hand.....	15
PSTBL521212	Pedestal Tower with Bookcase - Left Hand.....	18
PSTBL526612	Pedestal Tower with Bookcase - Left Hand.....	18

Catalog Number	Description	Page
PSTBL661212	Pedestal Tower with Bookcase - Left Hand.....	18
PSTBL666612	Pedestal Tower with Bookcase - Left Hand.....	18
PSTBR521212	Pedestal Tower with Bookcase -Right Hand.....	18
PSTBR526612	Pedestal Tower with Bookcase -Right Hand.....	18
PSTBR661212	Pedestal Tower with Bookcase -Right Hand.....	18
PSTBR666612	Pedestal Tower with Bookcase -Right Hand.....	18
PSTBWL501212	Bookcase Wardrobe Tower & Filing - Left Hand.....	19
PSTBWL506612	Bookcase Wardrobe Tower & Filing - Left Hand.....	19
PSTBWL521212	Bookcase Wardrobe Tower & Filing - Left Hand.....	19
PSTBWL526612	Bookcase Wardrobe Tower & Filing - Left Hand.....	19
PSTBWL581212	Bookcase Wardrobe Tower & Filing - Left Hand.....	19
PSTBWL586612	Bookcase Wardrobe Tower & Filing - Left Hand.....	19
PSTBWL661212	Bookcase Wardrobe Tower & Filing - Left Hand.....	19
PSTBWL666612	Bookcase Wardrobe Tower & Filing - Left Hand.....	19
PSTBWR501212	Bookcase Wardrobe Tower & Filing - Right Hand.....	19
PSTBWR506612	Bookcase Wardrobe Tower & Filing - Right Hand.....	19
PSTBWR521212	Bookcase Wardrobe Tower & Filing - Right Hand.....	19
PSTBWR526612	Bookcase Wardrobe Tower & Filing - Right Hand.....	19
PSTBWR581212	Bookcase Wardrobe Tower & Filing - Right Hand.....	19
PSTBWR586612	Bookcase Wardrobe Tower & Filing - Right Hand.....	19
PSTBWR661212	Bookcase Wardrobe Tower & Filing - Right Hand.....	19
PSTBWR666612	Bookcase Wardrobe Tower & Filing - Right Hand.....	19
PSTL521212	Single Tower - Left Hand.....	17
PSTL526612	Single Tower - Left Hand.....	17
PSTL661212	Single Tower - Left Hand.....	17
PSTL666612	Single Tower - Left Hand.....	17
PSTR521212	Single Tower - Right Hand.....	17
PSTR526612	Single Tower - Right Hand.....	17
PSTR661212	Single Tower - Right Hand.....	17
PSTR666612	Single Tower - Right Hand.....	17
PSWR536	Five-High Double-Door Wardrobe Cabinet.....	34
PSWR636	Six-High Double-Door Wardrobe Cabinet.....	34
SFDIV	Shelf/File Dividers.....	42
SS30E2	Storage Shelves.....	35
SS36E2	Storage Shelves.....	35
SS42E2	Storage Shelves.....	35
WRB36E	Wardrobe Bars.....	35
ZFPLFT1830	Lateral File Top - Thermofused Laminate.....	31
ZFPLFT1836	Lateral File Top - Thermofused Laminate.....	31
ZFPLFT1842	Lateral File Top - Thermofused Laminate.....	31
ZFPLFT1860	Lateral File Top - Thermofused Laminate.....	31
ZFPLFT1866	Lateral File Top - Thermofused Laminate.....	31
ZFPLFT1872	Lateral File Top - Thermofused Laminate.....	31
ZFPLFT1878	Lateral File Top - Thermofused Laminate.....	31
ZFPLFT1884	Lateral File Top - Thermofused Laminate.....	31
ZFPLFT3630	Lateral File Top - Thermofused Laminate.....	31
ZFPLFT3636	Lateral File Top - Thermofused Laminate.....	31
ZFPLFT3642	Lateral File Top - Thermofused Laminate.....	31
ZFPLFT3660	Lateral File Top - Thermofused Laminate.....	31
ZFPLFT3666	Lateral File Top - Thermofused Laminate.....	31
ZFPLFT3672	Lateral File Top - Thermofused Laminate.....	31
ZFPLFT3678	Lateral File Top - Thermofused Laminate.....	31
ZFPLFT3684	Lateral File Top - Thermofused Laminate.....	31
ZLHA	Pack Label Holders.....	32